

United States Department of Energy

**Savannah River Site
End State Vision**

July 26, 2005



THIS PAGE INTENTIONALLY LEFT BLANK

Acknowledgements

Special thanks to the following Department of Energy – Savannah River individuals who provided oversight, information and reviews of the *Savannah River Site End State Vision*.

Brian Hennessey, Lead
Joan Bozzone
Helen Belencan
Jay Bilyeu
Herbert Crapse
Jim DeMass
Jeff Galan
Dawn Gillas
Jim Giusti
Doug Hintze
Roxanne Jump
John Knox
Stephen Mackmull
Patrick McGuire
William Pearson
Randall Ponik
Karen Poore
Howard Pope
John Reynolds
Mike Simmons
Tom Treger

Special thanks to the following Westinghouse Savannah River Company individuals for providing invaluable assistance, knowledge, expertise, maps, figures, etc. for the *Savannah River Site End State Vision*.

Core Team

Michael Nelson, Lead
Thomas Gaughan
Gail Jernigan
David Nix
Robert Pride

Technical Support

Mary Flora
Sonny Goldston
Jim Moore
Michele Wilson

Thanks to Dean Campbell, WSRC Public Affairs, for taking the time to read and edit the document; and to Vonda Herrin, Madison Research Corporation, for superior publishing services.

THIS PAGE INTENTIONALLY LEFT BLANK

TABLE OF CONTENTS

Table of Contents

List of Figures and Tables

Acronyms

Executive Summary

ES-1.0 Background and General Site Description

ES-2.0 End State Vision Summary

ES-2.1 The End State Vision

ES-2.2 The End State Vision Purpose

ES-2.3 Key Features of the SRS ESV

ES-2.4 SRS Mission Summary: Current and Planned Missions

ES-2.4.1 Environmental Management

ES-2.4.2 National Nuclear Security Administration

ES-2.5 Regional Land Use – Current and End State

ES-2.6 Savannah River Site Land Use – Current and End State

ES-2.7 SRS Hazards

ES-2.8 Alternative End State Summary - Enablers and Recommended Congressional Action

ES-2.9 Recommended Congressional Action To Accelerate Cleanup

ES-2.10 End State Issues for National Consideration

ES-2.11 SRS Next Steps in the End States Process

ES-2.12 References

1.0 Introduction

1.1 Purpose and Supporting Documents

1.2 Organization of the Report

1.3 Hazard and Risk Relationship

1.3.1 Hazard Released

1.3.2 Hazard Contained

1.4 Site Missions

1.5 Cleanup Status

1.5.1 Cleanup Accomplished

1.5.2 End State Vision Summary

1.6 National Environmental Research Park

2.0 SRS Regional Context End State Vision Description

2.1 Physical and Surface Interface

2.1.1 Administrative

2.1.2 Watersheds

2.1.3 Transportation and Infrastructure

2.1.4 Surface Contamination

2.1.5 Hazard Areas of Concern

2.1.6 Differences Between Current State and 2025 end State

- 2.2 Human and Ecological Land Use
 - 2.2.1 Land Use
 - 2.2.2 Human Activities
 - 2.2.3 Differences Between Current State and 2025 End State
- 2.3 Regional Planning Interface

3.0 Savannah River Site Specific End State Vision Description

- 3.1 Physical and Surface Interface
 - 3.1.1 Administrative
 - Administrative Facilities
 - Non-nuclear Facilities
 - Nuclear/Radiological Facilities
 - 3.1.2 Watersheds
 - 3.1.3 Surface Water
 - 3.1.4 Transportation and Infrastructure
 - Transportation
 - Dams
 - Steam
 - Domestic Water
 - Firewater System
 - Process/River Water System
 - Sanitary Wastewater System
 - Electrical Distribution System
 - Emergency Services
 - Endangered Species
 - 3.1.5 Surface Contamination
 - 3.1.6 Future Infrastructure Needs and Plan
- 3.2 Human and Ecological Land Use
 - 3.2.1 Land Uses
 - 3.2.2 Differences Between Current State, PMP End State, and Vision End State
- 3.3 SRS Legal Ownership
 - 3.3.1 Site Ownership – Current and 2025 End State
 - 3.3.2 Surrounding Site Ownership
- 3.4 SRS Demographics
 - 3.4.1 Surrounding Site Demographics Differences Between Current and 2025 End State
- 3.5 Selection of Sites for Future Missions

4.0 Hazard Specific Discussion

- 4.1 Chapter Purpose
 - 4.2 Site Hazards, Risk and Controls for Contained and Released Hazards
 - 4.2.1 Hazard: Plutonium (Pu)
 - 4.2.2 Hazard: Uranium (HEU and DU)
 - 4.2.3 Hazard: Spent Nuclear Fuel
 - 4.2.4 Hazard: Tritium
 - 4.2.5 Hazard: Liquid radioactive waste
 - 4.2.6 Hazard: Transuranic (TRU) Waste
-

- 4.2.7 Hazard: Low Level Waste
 - Solid Low Level Waste
 - Liquid Low Level Waste
- 4.2.8 Hazard: Mixed Waste
- 4.2.9 Hazard: Hazardous Waste
- 4.2.10 Hazard: Sanitary Waste
- 4.2.11 Hazard: EM Facilities
 - 4.2.11.1 Nuclear and Radiological Facility End State Evaluation and Decision-Making
- 4.2.12 Hazard: Contaminated Soil and Groundwater
- 4.3 Hazard Specific Discussion by Watersheds
 - 4.3.1 Upper Three Runs Watershed
 - 4.3.2 Fourmile Branch Watershed
 - 4.3.3 Pen Branch Watershed
 - 4.3.4 Steel Creek Watershed
 - 4.3.5 Lower Three Runs Watershed
 - 4.3.6 Savannah River / Floodplain / Swamp Watershed
- 4.4 Hazard-Specific Discussion by Areas
 - 4.4.1 A Area
 - 4.4.2 B Area
 - 4.4.3 C Area
 - 4.4.4 D Area
 - 4.4.5 E Area
 - 4.4.6 F Area
 - 4.4.7 G Area
 - 4.4.8 H Area
 - 4.4.9 K Area
 - 4.4.10 L Area
 - 4.4.11 M Area
 - 4.4.12 N Area
 - 4.4.13 P Area
 - 4.4.14 R Area
 - 4.4.15 S Area
 - 4.4.16 T Area
 - 4.4.17 Z Area

Appendices:

- A. Regional and Site Maps
 - B. Alternative End States and Recommendations
 - C. Regional Planning Initiatives
 - D. Regulatory Support and Agreements
 - E. Long Term Stewardship
 - F. References
 - G. Land Use, Risk and Cleanup Decision Process
 - H. Public Comment Matrix
 - I. Watershed Conceptual Site Models and Hazard Tables
-

- J. Area Conceptual Site Models and Hazard Tables
 - K. Conceptual Site Models for Typical SRS Hazards (Soil, Groundwater, EM Facilities, LRW Tanks)
-

LIST OF FIGURES AND TABLES

Chapter 1 Introduction

Figure 1.1	Basic Document Organization
Figure 1.2	Critical Decision Path to Area Completion
Figure 1.3	Basic Area Completion Process
Figure 1.4	ESV Area Completion Plan
Table 1.1	Gold Metrics

Chapter 2 SRS Regional Context End State Vision Description

Table 2.1	CSRA National Priority List Sites
Table 2.2	CSRA County Populations

Chapter 4 Savannah River Site Specific End State Vision Description

Figure 4.1	EM Owned Nuclear Materials at SRS
Figure 4.2	EM Owned Nuclear Materials (continued)
Figure 4.3	EM Owned Nuclear Materials at SRS (continued)
Figure 4.4	Material movements currently in the Waste Management Program
Figure 4.5	Tritium Reprocessing and New Processing Material Disposition Map
Table 4.1	SRS Hazards, Current Status and End State
Table 4.2	Site D&D Table
Table 4.3	A-Area D&D Table
Table 4.4	B-Area D&D Table
Table 4.5	C-Area D&D Table
Table 4.6	D-Area D&D Table
Table 4.7	E-Area D&D Table
Table 4.8	F-Area D&D Table
Table 4.9	G-Area D&D Table
Table 4.10	H-Area D&D Table
Table 4.11	K-Area D&D Table
Table 4.12	L-Area D&D Table
Table 4.13	M-Area D&D Table
Table 4.14	N-Area D&D Table
Table 4.15	P-Area D&D Table
Table 4.16	R-Area D&D Table
Table 4.17	S-Area D&D Table
Table 4.18	T-Area D&D Table
Table 4.19	Z-Area D&D Table

Appendix A Regional and Site Maps

Map 2.1	Regional Physical and Surface Interface-Current State (2003)
Map 2.2	Regional Watershed Map – Current State (2003)
Map 2.3	Regional Human and Ecological Land Use – Current State (2003)

Map 3.1	Site Physical and Surface Interface – Current State (2003)
Map 3.2	Site Human and Ecological Land Use – Current State (2003)
Map 3.3	Site Legal Ownership – Current State (2003)
Map 3.4	Current Locations without Restrictions
Map 3.5	Future Development – Suitable for Industrial Missions

Appendix B Alternative End States and Recommendations

Map B.1	Alternative End State No. 1
---------	-----------------------------

Appendix I Watershed Conceptual Site Models and Hazard Tables

NOTE: Some figures were deleted; original figure numbers have been retained for the remaining figures.

Figure 4.0	SRS Sitewide Conceptual Site Model
Figure 4.1b	Upper Three Runs Watershed/ Integrator Operable Unit (IOU) G Area Conceptual Site Model (CSM)
Figure 4.2b	Fourmile Branch Watershed G Area IOU
Figure 4.3b	Pen Branch Watershed G Area CSM
Figure 4.4b	Steel Creek Watershed/IOU G Area CSM
Figure 4.5b	Lower Three Runs Watershed G Area CSM
Figure 4.6b	Savannah River Watershed G Area CSM
Table 4.1a	SRS End State Vision Planned by Watersheds (G-Area Only)
Table 4.1b	EM Integrated Deactivation and Decommissioning Plan (G-Area Only)
Table 4.2	SRS End State Vision Hazard Type Crosswalk for Watershed “To Go” Units (G-Area Only)

Appendix J Area Conceptual Site Models and Hazard Tables

NOTE: Some figures were deleted; original figure numbers have been retained for the remaining figures.

Figure 4.7b.1	A Area CSM for Upper Three Runs
Figure 4.7b.2	A Area CSM for Savannah River
Figure 4.8b	B Area CSM for Upper Three Runs
Figure 4.9b	C Area CSM for Four Mile Branch
Figure 4.10b	D Area CSM for the Savannah River and Floodplain Swamp
Figure 4.11b.1	E Area CSM for Four Mile Branch
Figure 4.11b.2	E Area CSM for Upper Three Runs
Figure 4.12b.1	F Area CSM for Four Mile Branch
Figure 4.12b.2	F Area CSM for Upper Three Runs
Figure 4.13b.1	H Area CSM for Four Mile Branch
Figure 4.13b.2	H Area CSM for Upper Three Runs
Figure 4.14b	K Area CSM for Pen Branch
Figure 4.15b.1	L Area CSM for Pen Branch
Figure 4.15b.2	L Area CSM for Steel Creek
Figure 4.16b.1	M Area CSM for Upper Three Runs
Figure 4.16b.2	M Area CSM for the Savannah River
Figure 4.17b.1	N Area CSM for Four Mile Branch

Figure 4.17b.2 N Area CSM for Pen Branch
Figure 4.18b.1 P Area CSM for Lower Three Runs
Figure 4.18b.2 P Area CSM for Steel Creek
Figure 4.19b.1 R Area CSM for Lower Three Runs
Figure 4.19b.2 R Area CSM for Upper Three Runs
Figure 4.20b S Area CSM for Upper Three Runs
Figure 4.21b T Area CSM for SR and Floodplain Swamp
Figure 4.22.b Z Area CSM for Upper Three Runs
Table 4.3a SRS End State Vision Planned by Area
Table 4.3b EM Integrated Deactivation and Decommissioning Plan
Table 4.4a SRS End State Vision Hazard Type Crosswalk for Area "To Go" Units

Appendix K Conceptual Site Models for Typical SRS Hazards (Soil, Groundwater, EM Facilities, LRW Tanks)

Figure 4.23b Generic Conceptual Site Model
Figure 4.24b Group 1: Burial Ground Complex CSM
Figure 4.25b Group 1: Burial Ground Complex (continued) CSM
Figure 4.26b Group 2: Radiological Seepage Basins and Pits CSM
Figure 4.27b Group 3: Coal Pile Runoff Basins and Ash Basins CSM
Figure 4.28b Group 4: Inactive Process Sewer Lines CSM
Figure 4.29b Group 5: Nonradiological Rubble Piles and Pits CSM
Figure 4.30b Group 6: Nonradiological Seepage Basins CSM
Figure 4.31b Group7: Sludge Application Sites CSM
Figure 4.32b Group 8: Acid/Caustic Basins CSM
Figure 4.33b Group 9: Miscellaneous Sites CSM
Figure 4.34b Decommissioned Facilities CSM
Figure 4.35b Group 1: High Hazard Facilities CSM
Figure 4.36b Group 2: Medium Hazard Facilities CSM
Figure 4.37b Group 3: Low Hazard Facilities CSM
Figure 4.38B Group 4: Liquid Radioactive Waste Tanks CSM

THIS PAGE IS INTENTIONALLY LEFT BLANK

ACRONYM LIST

ACHP – Advisory Council on Historic Preservation	DWPF – Defense Waste Processing Facility
ACL – Alternate Concentration Limits	EE/CA – Engineering Evaluation/Cost Analysis
Am/Cm – Americium/Curium	EIS – Environmental Impact Statement
ARARs – Applicable or Relevant and Appropriate Requirements	EM – Environmental Management
ARP -- Actinide Removal Process	EPA – Environmental Protection Agency
BGC – Burial Ground Complex	ESS – Essential Site Services
BNG – British Nuclear Group	ET #1 – Engineered Trench #1
C&D – Construction and Demolition	ETF – Effluent Treatment Facility
CAB – Citizens Advisory Board	ETP – Effluent Treatment Project
CCP – Comprehensive Cleanup Plan	FERE – Federal Energy Regulatory Commission
CERCLA – Comprehensive Environmental Response, Compensation and Liability Act	FFA – Federal Facility Agreement for the Savannah River Site
CFL – Comprehensive Facility List	FL – Office of Future Remediation and Waste Management Liabilities
CIF – Consolidated Incineration Facility	FMB – Four Mile Branch
CLAB – Central Laboratory Facility	FML – flexible membrane liner
CMPC – classified matter protection and control	FR – Federal Register
CRESP – Consortium of Risk Evaluation with Stakeholder Participation	FTF – F-Tank Farm
CRMP – Savannah River Site’s Cold War Built Environment Cultural Resources Management Plan	G&A – General and Administrative
CSM – Conceptual Site Model	gpm – gallons per minute
CSO – Cognizant Secretarial Office	GSA OU – General Separations Area Consolidation Unit
CSRA – Central Savannah River Area	GWSB – Glass Waste Storage Building
CSSX -- caustic side solvent extraction	HATF – High Activity TRU Facility
CSWTF – Central Sanitary Wastewater Treatment Facility	HEU – Highly Enriched Uranium
D&D – Deactivation and Decommissioning	HTF – H-Tank Farm
DDA -- Deliquification, Dissolution, and Adjustment	HVAC – Heating, ventilation and air-condition
DNFSB – Defense Nuclear Facilities Safety Board	HW – Heavy Water
DOE – Department of Energy	HWCTR -- Heavy Water Components Test Reactor
DOE-HQ – Department of Energy-Headquarters	IC – Institutional Controls
DOE-SR – Department of Energy-Savannah River Operations Office	IOU – Integrator Operable Unit
DOT – Department of Transportation	ILV – Intermediate Level Vaults
DSA – Documented Safety Analysis	IPABS – Integrated Planning Accountability and Budgeting System
DU – Depleted Uranium	ISD – In-Situ Disposal
DUO – depleted uranium trioxide powder	ISMS – Integrated Safety Management System
DUN – Depleted Uranyl Nitrate	JCO – Justification for Continued Operation
	KAMS – K-Area Material Storage Facility Project
	kV – kilo volt
	LAWV – Low Activity Waste Vaults
	LEU –Low Enriched Uranium

LFL – Lower Flammability Limit	ORWBG -- Old Radioactive Waste Burial Ground
LFRG – LLW Federal Review Group	OSWER – Office of Solid Waste and Emergency Response
LLRWDF– Low-Level Radioactive Waste Disposal Facility	PA – Programmatic Agreement
LLMW – Low Level Mixed Waste	PA – Performance Assessment
LLW – Low-Level Waste	PAR – Probabilistic Risk Assessment
LLWF – Low Level Waste Facility	PB – Pen Branch
LRW – Liquid Radioactive Waste	PCBs – polychlorinated biphenyls
LTR – Lower Three Runs	PDCF – Pit Disassembly and Conversion Facility
LTS – Long Term Stewardship	PMP—Performance Management Plan
LUC – Land Use Controls	Pu – Plutonium
LUCAP – Land Use Control Assurance Plan	PUREX – Plutonium/Uranium Extraction
LUCIP – Land Use Control Implementation Plan	RAO—Remedial Action Objective
MCL – maximum contaminant limits	RBES – Risk-Based End State
MCU -- Modular Caustic Side Solvent Extraction Unit	RBOF – Receiving Basin for Offsite Fuels
Mk – Mark	RCRA – Resource Conservation and Recovery Act
M-LTS – Maintenance – Long Term Stewardship	ROD – Record of Decision
MNA – Monitored Natural Attenuation	ROM – Rough Order of Magnitude
MOA – Memorandum of Agreement	RSM – Ranking and Sequencing Model
MOX – Mixed Oxide	RW – Office of Civilian Radioactive Waste Management
MPF – Modern Pit Facility	RWMB – Radioactive Waste Management Basis
MST -- monosodium titanate	S&M – Surveillance and Maintenance
MTHM – metric tons of heavy metal	S&S – Safeguards and Security
MW – Mixed Waste	S/S – Stabilization/Solidification
MWMF – Mixed Waste Management Facility	SAR – Safety Analysis Report
MZCL -- Mixing Zone Concentration Limits	SC – Steel Creek
NDAA -- National Defense Authorization Act	SCDHEC – South Carolina Department of Health and Environmental Control
NEPA – National Environmental Policy Act	SCE&G – South Carolina Electric and Gas
NERP – National Environmental Research Park	SCF – Supercompactor Facility
NMM – Nuclear Materials Management	SEURR – Southeast Universities Research Reactor
NNSA – National Nuclear Security Administration	SGP – Soils and Groundwater Project
NNSA-DP – National Nuclear Security Administration – Defense Programs	SHPO – State Historic Preservation Office
NNSA-NN – National Nuclear Security Administration-Nuclear Nonproliferation	SNF – Spent Nuclear Fuel
NOx – nitrogen oxides	SNM – Special Nuclear Materials
NPDES – National Pollutant Discharge Elimination System	SRARP – Savannah River Archaeological Research Program
NPL – National Priority List	SREL – Savannah River Ecology Laboratory
NRC – Nuclear Regulatory Commission	SRNL – Savannah River National Laboratory
NRHP – National Register of Historic Places	SROO – Savannah River Operations Office
NTS – Nevada Test Site	SRS – Savannah River Site

SRTC – Savannah River Technology Center
SVOC – Semi-Volatile Organic Compound
SW – Solid Waste
SWD – Solid Waste Division
SWMF – Solid Waste Management Facility
SWPF – Salt Waste Processing Facility
TEF – Tritium Extraction Facility
TFRG – TRU Waste Disposal Facility Federal Review Group
TRU – Transuranic Waste
TSF – Treatment and Storage Facility
TSR – Technical Safety Requirement
TVA – Tennessee Valley Authority
TRSWA – Three Rivers Solid Waste Authority
UCNI – unclassified controlled nuclear information

USEPA – United States Environmental Protection Agency
USFS-SR – USDA United States Forest Service - Savannah River
UTR – Upper Three Runs
VZMS – Vadose Zone Monitoring System
VE – Visual Examination
VOCs – volatile organic compounds
WAC -- Waste Acceptance Criteria
WD – Waste Determination
WIPP – Waste Isolation Pilot Plant
WIR – Waste Incidental to Reprocessing
WOW – Waste on Wheels
WSI – Wackenhut Services, Inc.
WSRC – Westinghouse Savannah River Company

THIS PAGE INTENTIONALLY LEFT BLANK

EXECUTIVE SUMMARY

ES.1.0 Background and General Site Description

During the early 1950s the Savannah River Site (SRS) began to produce materials used in nuclear weapons, primarily tritium and plutonium-239. Five reactors were built to produce these materials. Also built were supporting facilities including two chemical separations plants, a heavy water extraction plant, a nuclear fuel and target fabrication facility a tritium extraction facility and waste management facilities. After 40 years of producing nuclear materials for defense and non-defense uses, the SRS shifted its strategic direction and resources from nuclear weapons production to cleanup of the nuclear waste and environmental contamination created during production.

Today the SRS is a key Department of Energy (DOE) industrial complex dedicated to accelerated environmental cleanup, providing capability for supporting the enduring nuclear weapons stockpile, and processing and storing nuclear materials in support of the U.S. nuclear non-proliferation efforts. The Savannah River National Lab (SRNL), formerly the Savannah River Technology Center (SRTC), also develops and deploys technologies to support the accelerated cleanup, national security and energy security. SRS is designated as a National Environmental Research Park (NERP).

Environmental Management (EM) and National Nuclear Security Administration (NNSA) are the primary DOE programs and missions being carried out at SRS. SRS's FY05 budget is approximately \$1.8 billion with approximately 80% dedicated to the EM Cleanup Project, 17% to NNSA and the remaining 3% to other DOE and federal programs.

The SRS complex covers 198,344 acres or 310 square miles, with industrial facilities (active and inactive) occupying less than 10% of the total area. It encompasses parts of Aiken, Barnwell and Allendale counties in South Carolina and borders the Savannah River.

The site is owned by DOE and operated by an integrated team led by Westinghouse Savannah River Company, LLC (WSRC) a subsidiary of Washington Group International's Energy and Environment Operations. The contract⁷, which went into effect October 1, 1996, is in effect through November 30, 2006. It was revised June 18, 2003, to provide significant modifications to accelerate the near-term schedule of the EM Cleanup Project beyond the goals of the EM Program Performance Management Plan (PMP) that was issued August 7, 2002, and revised in April 2004. (The 2005 PMP is currently being written.) The SRS EM Program PMP is considered to be the SRS EM Cleanup project baseline for purposes of this End State Vision. The WSRC contract scope is primarily responsible for DOE missions for EM, NNSA Defense Programs and support for NNSA Non-Nuclear Proliferation Programs. This also includes SRNL and the site's administrative and landlord functions that are under EM responsibility at SRS.

Other major DOE contractors at SRS include Wackenhut Services, Inc. (WSI) for security services and the University Of Georgia, which operates the Savannah River Ecology Laboratory (SREL). The DOE is also responsible for natural resources management under terms of an interagency agreement with the USDA United States Forest Service.

ES.2.0 End State Vision Summary

DOE "began with the end in mind" during the early stages (mid-1990s) of the SRS cleanup program. Collaboratively working with SRS

stakeholders and regulators, the SRS developed the *SRS Future Land Use Report* and confirmed this future use in the 1998 *DOE Future Use Report to Congress*. In this report, the DOE made significant declarations and confirmations of future land use end states that are the basis for cleanup to industrial (not residential) use.

Key ESV Themes

- The *SRS ESV* is a concise stakeholder's guide to current conditions at SRS and the conditions DOE plans to achieve through the site's EM Cleanup Project.
- The *ESV* describes current conditions and planned end states; however, it is not encyclopedic and data-intensive in its description. Many stakeholders will find this approach useful as an information source for future decisions about SRS areas and hazard end states.
- Periodic review of end states with stakeholders is not a static situation but is a continually evolving and improving process to support the EM Cleanup Project.
- Planned end states and schedules are not static. They have changed over time, as evidenced by the differences between the 2002 *PMP* and the 2004 *PMP* and will continue to change as DOE continues to seek and find new ways to reduce risk more cost-effectively. Stakeholders will always have the needed information to evaluate potential changes in planned end states.
- The *ESV* is not a decision document. Individual hazards and areas will be evaluated in greater detail, with ample stakeholder involvement, at the appropriate time to support decision-making.
- The evaluation method includes the elements of the Risk-Informed Decision-Making Approach described in *Risk and Decisions About Disposition of Transuranic and High-Level Radioactive Waste* (National Academy of Sciences, 2005).

ESV Chronology

On July 15, 2003, DOE issued DOE Policy 455.1, *Use of Risk -Based End States*, followed by guidance to support the implementation of this policy, by developing a site specific *End State Vision* document for every site where cleanup is being conducted. The *ESV* is the primary tool for communicating the individual site end states to the involved parties (i.e., DOE, regulators, public stakeholders, tribal nations, etc.). The guidance uses a standardized approach to portray a site's current state and planned and alternative end states by using narrative, maps, and conceptual site models.

SRS issued its first draft version, *Savannah River Site Risk-Based End State Vision*, in March 2004, following the DOE-HQ guidance. A Citizens Advisory Board (CAB) public meeting was held to discuss the draft, and the CAB made a recommendation (#190) on ways to improve the document. (See Appendix H, *Public Comment Matrix*.)

The next draft, *Savannah River Site End State Vision, Revision 2*, was issued in March 2005. Another CAB public meeting—a Stakeholders' End State Vision Workshop—was held on March 24, 2005, to discuss the draft and accept comments. (See Appendix H, *Public Comment Matrix*.) The CAB issued recommendation #216 on the *SRS End State Vision* in May 2005. SRS had planned to submit the final *End State Vision* document to DOE Headquarters in May, but postponed its submittal to accommodate and consider the CAB recommendation.

This final version of the *SRS ESV* describes current conditions and planned end states for contained and released hazards (all fourteen categories of hazards at SRS), where the earlier drafts focused only on released hazards for inactive soil and groundwater units and EM legacy facilities. Other features include:

- A "reader's guide" to facilitate use of the region, site, watershed and area hazard descriptions

- The public comments and response summaries from previous public involvement
- CAB Recommendations #190 (May 2004) and #216 (May 2005) with DOE responses
- Feedback from the National Governors' Association Next Steps Workshop (October 2004)
 - End States are not strictly "risk-based" but are logical, technically defensible, and protective of human health and the environment; therefore, the title has changed to *End State Vision*.
 - "Variances" have been renamed "Alternative End States" to remove the perception of deviation from laws and regulations.
- Expanded evaluation of Alternative End States
 - 1) Some previous Alternative End States (AES) (in-situ decommissioning and increased canister loading at the Defense Waste Processing Facility [DWPF]) are no longer AES but have been incorporated into the PMP baseline.
 - 2) Alternative End State #5, Area Completion, has been reinstated for consideration and potential application across the DOE complex. This alternative is currently being developed for implementation at SRS.
- Better defined future use of previous industrial areas within the existing SRS Future Land Use Plan
- Impacted areas identified
- Benefits and risk reduction better described
- The alternative regarding Area Risk Methodology, deleted from March 2005 draft, restored
- National Environmental Research Park description included
- Description of key factors to be considered in Facility End State Evaluation (for nuclear and radiological facilities) added, including opportunities for community involvement
- Quality of maps improved
- M Area now depicted as a future Industrial, rather than Maintenance (non-industrial), Area in Appendix B (Alternative End States)

ES 2.1. The End State Vision

The goal of the SRS EM Cleanup Project and resulting *SRS End State Vision* (ESV) is to dispose of all EM nuclear material and waste hazards permanently, decommission all EM facilities and remediate all SRS inactive waste units. The vast majority of EM nuclear material and waste hazards will be permanently removed from SRS and dispositioned offsite. Inactive waste units will be remediated by deploying an area-by-area closure and deletion strategy. Concurrently with area closure, all EM facilities will be decommissioned unless reused to support other long-range federal missions at SRS or designated for historical preservation or economic development. Inactive waste units will eventually be deleted from the National Priorities List (NPL) of Superfund sites.

With the removal and offsite disposition of EM nuclear material and waste hazards, the remaining hazards at SRS will be orders of magnitude less in quantity and risk than the current hazards. Any residual hazards to onsite and offsite receptors will be significantly reduced to an acceptable risk level that is protective of onsite and offsite potential

Key Changes to *End State Vision*

- CAB Recommendation #216 (May 24, 2005) and DOE response letter and stakeholder comments on the March 2005 draft, including those given at the Stakeholder ESV Workshop, with responses
- Enhanced description of Area Completion process, showing public involvement opportunities
- Status of cleanup on each hazard updated to reflect Gold Metrics as of June 30, 2005
- Alternative End States narratives (Appendix B, *Alternative End States*) improved

July 26, 2005

receptors and consistent with environmental laws and regulations.

By 2025, all inactive waste sites that pose an unacceptable risk to surface water or groundwater will be remediated, and any contaminated groundwater will be remediated or undergoing remediation. Units that leave waste in place will be under institutional controls that feature access restrictions and an inspection, maintenance, and monitoring program.

The vision for SRS includes the following:

- SRS land will be federally owned, controlled and maintained in perpetuity, as established by Congress.
- EM Cleanup Project and mission will be complete by 2025 and ongoing NNSA nuclear industrial missions will continue. SRS is a site with an enduring mission and is not a closure site.
- EM Cleanup will be complete consistent with *SRS EM Program Performance Management Plan (PMP)*:
 - EM nuclear materials will be removed from SRS and dispositioned offsite.
 - Waste (liquid radioactive, transuranic, mixed and hazardous) will be removed from SRS and dispositioned offsite except for the waste facilities closed and monitored in accordance with the Federal Facility Agreement (FFA) and the Resource Conservation and Recovery Act (RCRA) permit for wastes.
 - All SRS inactive waste units will be remediated and deleted (or proposed for deletion) from the National Priorities List (NPL) of Superfund sites, and institutional controls will be in place to ensure access to remediated waste units is limited.
 - All EM facilities will be permanently decommissioned by demolition or in situ disposal unless reused by another federal program or designated for

historical preservation or for economic development.

- Low level waste will be disposed on site in accordance with the Atomic Energy Act and DOE Order 435.1, *Radioactive Waste Management*.
- Facilities associated with NNSA missions, their supporting waste management and essential site infrastructure are anticipated to remain active and appropriately sized to support ongoing missions.
- Long-term Stewardship activities will continue, to ensure that EM cleanup project remedies and end states remain protective (see Appendix E, *Long Term Stewardship*). Environmental research consistent with the SRS NERP designation will continue to validate the protectiveness of end states and long term stewardship activities.

This *End State Vision* directly supports the environment and defense strategic goals in the *Department of Energy Strategic Plan*².

ES 2.2. The End State Vision Purpose

The purpose of the *ESV* is to ensure cleanup is focused and achieves clearly defined, mutually agreed-upon and technically defensible end states that are protective and sustainable and reflect the planned future use of the property. The Vision goal is to improve the effectiveness and accelerate the cleanup process by increasing stakeholder understanding of current conditions and planned end states.

ES 2.3. Key Features of the SRS *ESV*

- SRS has demonstrated positive results and success by employing “risk balancing” methods and will continue with the Alternative End State options evaluations.
 - Strong stakeholder support and collaborative regulator working relationships are cornerstones of DOE Savannah River
-

Operations Office's (DOE-SR) past, current and future success. Regulators and the public already agree with DOE SR's EM end state as stated in the PMP and *SRS Future Land Use Report*. (Ref: 1995 CAB Future Land Use Recommendation #8, Regulator Letter Of Support and July 2003 MOA in Support of Accelerated Cleanup)

- SRNL, SREL, the Consortium of Risk Evaluation and Stakeholder Participation (CRESP) and National Academy of Sciences are partnering with DOE Science Program to improve methods for cleanup, as well as assisting other DOE facilities and federal agencies.
- SRS uses a graded approach to End State Vision data requirements.

ES 2.4. SRS Mission Summary: Current and Planned Missions

The SRS Cleanup Project mission and goal is to complete the cleanup by 2025 and transition SRS to a site focused on national security¹. SRS will accommodate the ongoing NNSA missions before and beyond 2025. SRS is not a DOE closure site.

ES 2.4.1. Environmental Management

The *EM Program Performance Management Plan*⁹ (PMP) is the SRS baseline for the EM accelerated cleanup mission. The SRS EM cleanup program involves completing the removal of waste from all liquid radioactive waste (LRW) tanks and closing all the tanks; completing nuclear materials stabilization and processing in the canyons and separations facilities; consolidating and dispositioning spent nuclear fuel; treating and disposing of solid wastes; remediating contaminated groundwater and soil; and deactivating and decommissioning EM facilities. This ESV provides a mission plan and area end state update that reflects any changes resulting from the June 2003 DOE-SR Contract Modification and *EM Life Cycle Baseline Required Program Guidance*¹⁰.

ES 2.4.2. National Nuclear Security Administration

In support of the DOE's NNSA Defense Program missions, SRS has been designated to continue as DOE's center for the tritium supply to the enduring nuclear weapons stockpile. The primary new source of tritium will be an existing commercial reactor in the Tennessee Valley Authority system. Tritium extraction from targets and loading into containers for shipment to the Department of Defense will continue to be a SRS long-term mission beyond 2025.

In support of the DOE's NNSA Nuclear Non-Proliferation missions, SRS has been selected to "blend down" weapons usable highly enriched uranium fuel (irradiated and unirradiated) to low-enriched uranium that can be converted to reactor fuel suitable for commercial nuclear power reactors.

Additionally, in January 2000, the Secretary of Energy announced that SRS will be the location for the DOE's facilities to disposition 34 metric tons of surplus weapons grade plutonium as mixed oxide (MOX) fuel to be irradiated in commercial nuclear reactors. The MOX conversion process is expected to cost \$3.8 billion over 20 years. The current schedule would build, operate and complete its current mission before 2025.

ES 2.5. Regional Land Use – Current and End State

The current regional land uses surrounding SRS are primarily forestry and agricultural with secondary use by industry and government operations, light residential and recreation. The forestry and agricultural surrounding land use is not expected to change appreciably by 2025.

ES 2.6. Savannah River Site Land Use – Current and End State

The current *SRS Future Land Use Plan* (see References 3, 4, 5 and 6) assumes that the entire site will be owned and controlled by the federal government in perpetuity and used for industrial purposes for future DOE and non-DOE missions. Site boundaries will remain unchanged. Residential use will not be allowed onsite. Offsite repositories will be available for liquid radioactive, transuranic, hazardous, and mixed waste.

The current *SRS Future Land Use Plan* concentrates future industrial land use operations toward the center of the site to form a central industrial core for continuing missions. The central industrial core is surrounded by concentric site industrial support and general support land use areas.

The ESV assumes the same SRS future land use plan and proposes a revised future land use scenario for limited portions industrial areas where no future industrial missions are planned. Reference Alternative End State #1 (Appendix B, *Alternative End States and Recommendations*) which proposes a non-industrial (Maintenance/Long-term Stewardship) use scenario.

ES 2.7. SRS Hazards

All SRS hazards are summarized in five major classes and 14 sub-categories:

- **Nuclear Materials:** plutonium, uranium, spent nuclear fuel (SNF), and tritium.
- **Radiological Waste:** liquid radioactive waste (LRW), transuranic (TRU) waste, low level waste (LLW) and low level mixed waste (LLMW).
- **Non-Radiological Waste** Hazardous and sanitary
- **Inactive Waste Units:** Soil and groundwater

- **EM Facilities:** Nuclear, radiological, other industrial facilities, and LRW tanks

ES 2.8. Alternative End State Summary - Enablers and Recommended Congressional Action

SRS has identified five alternative end states. For the purposes of this document, a alternative end state is defined as a significantly different cleanup approach or different end state relative to the original SRS EM PMP.

It is important to note that the proposed alternative end states and recommendations are considered to be “enablers” to accomplish the EM Cleanup project by 2025 within the desired out year funding targets. Currently the SRS EM life cycle baseline (technical scope, cost and schedule) is in the process of validation. After baseline validation, the alternative end states will be reassessed for changes to the EM Cleanup project baseline.

The following alternative end states are submitted for consideration. Alternative end states with associated implementation recommendations are included in *Appendix B, Alternative End States and Recommendations*.

- Future Land Use and Exposure Scenario Modification
- Alternate Disposal for Plutonium-238 Transuranic Contaminated Waste
- In Situ Decommissioning in lieu of Demolition
- Increased High-Level Waste DWPF Canister Loading
- Area Completion

ES 2.9. Recommended Congressional Action To Accelerate Cleanup

SRS recommends formal Congressional Authorization to provide perpetual federal ownership and responsibility for SRS’s fixed boundaries.

July 26, 2005

ES 2.10. End State Issues for National Consideration

Significant challenges to SRS mission planning and accelerating cleanup are:

- *Need for a DOE-wide integrated disposition plan and process for DOE nuclear materials and waste.* Consolidation strategy and disposition paths are critical to EM cleanup completion and baseline risk management.
- *Liquid radioactive waste federal repository startup and optimization of LRW and transuranic repository loading.*
- *Federal government ownership of SRS in perpetuity.* This would enhance the reliability and credibility of the federal government's institutional controls and land use on its property, with resultant control over human exposure to residual hazards.
- *Groundwater cleanup standards and points of compliance.* Given the federal government's ownership of SRS and aquifer and land use control in perpetuity, and the technical difficulty and expense of restoring groundwater to Maximum Contaminant Levels, objectives for groundwater remediation (which currently assume human consumption) could be developed that are not drinking-water based.

ES 2.11. SRS Next Steps in the End States Process

The *SRS End State Vision (ESV)*:

- defines the end state for materials, wastes, and facilities as described in the SRS EM PMP, similar to project requirements for a construction project. The EM PMP references its dependency on the ESV.
- is a subset of the comprehensive long-range planning for DOE mission, infrastructure and land use.
- bridges the gap to post-EM long term stewardship and continuing missions at SRS.
- ensures stakeholder involvement in the ESV process, leading to involvement with cleanup decisions and SRS missions.

- is an additional planning vehicle to support the FFA Appendix E (out year scope).

The "next steps" at SRS are to:

- Annually review the end states with key stakeholders to include SRS mission requirements and land use. (Note: this is a continuing comprehensive planning process with stakeholders that was initiated in 1995.)
- Network with other DOE sites to develop and implement an integrated disposition plan for nuclear materials and waste. EM Cleanup baselines at multiple sites are at risk until a single DOE-wide integrated disposition plan for all nuclear materials and waste is established.
- Periodically assess the EM PMP to ensure program planning and execution are aligned with the *End State Vision*.
- Periodically assess other planned and potential SRS missions to facilitate and optimize SRS facilities and infrastructure mission decisions.
- Continue to identify Alternative End State (AES) cleanup options for evaluation.
- Amend the Core Team process with the regulators to establish an End State Core Team to ensure proactive regulatory involvement for measuring end state progress, evaluation of AES opportunities, long-term stewardship transition and monitoring area closure.

ES 2.12. References:

1. *Definition of Environmental Management Completion, Jessie Roberson to EM Field Office Managers, February 12, 2003.*
 2. *DOE Strategic Plan, Protecting National, Energy, and Economic Security with Advanced Science and Technology and Ensuring Environmental Cleanup* September 30, 2003
 3. *SRS Long Range Comprehensive Plan, December 2000,*
-

-
4. *SRS Citizen's Advisory Board Recommendation No. 8, Future Land Use*, September 26, 1995.
 5. *Report, SRS Future Use Project Report*, Jan., 1996, Memo, Mario P Fiori to Thomas P. Grumbly (EM-1)
 6. *DOE Report to Congress: Planning For The Future, An Overview Of Future Use Plans At Department Of Energy Sites*, October 7, 1998
 7. *DOE-SR and SRSO Performance Evaluation and Measurement Plan for WSRC LLC Contract No. DE-AC09-96SR185000, Modification No. M100*, June 18, 2003.
 8. *Savannah River Site, Risk-Based End State Vision*, Draft: March 30, 2004.
 9. *SRS Environmental Management Program Performance Management Plan (EM-PMP)*, Predecisional Draft, April, 2004.
 10. *Environmental Management Life Cycle Baseline – Required Program Guidance*, J. M. Allison to R. A. Pedde, September 16, 2003
 11. *Savannah River Site's Cold War Built Environmental Cultural Resources Management Plan*, January 26, 2005.
 12. *Programmatic Agreement Among the U. S. Department of Energy (DOE), the State Historic Preservation Office (SHPO), and the Advisory Council on Historic Preservation (ACHP) for the Management of Cold War Historic Properties on the Savannah River Site (SRS), Aiken, Barnwell, and Allendale counties, South Carolina*, May 2004
 13. *Risk and Decisions About Disposition of Transuranic and High-Level Radioactive Waste* (National Academy of Sciences, 2005)
-

1.0 Introduction

1.1 Purpose and Supporting Documents

In 2002, the Office of Environmental Management (EM) of the Department of Energy (DOE) published the *Top-to-Bottom Review of the EM Program*, which identified several challenges facing the DOE-EM Program, revealed by cost and schedule estimates determined by an independent review team. Later that same year, EM established a set of corporate projects to change the way EM and DOE conducts business. Since the *Top-to-Bottom Review* was issued, EM has taken aggressive action to accelerate risk reduction, instead of focusing on risk management. In order to support this approach, the Department issued DOE Policy 455.1, *Use of Risk-Based End States* in July 2003.

The purpose of the policy and its complementary guidance is to ensure cleanup is focused and achieves clearly defined, mutually agreed-upon, and technically defensible end states that are protective and sustainable, and reflect the planned future use of the property. The *End State Vision* (ESV) goal is to improve the effectiveness and accelerate the cleanup process.

The *Savannah River Site (SRS) End State Vision* was developed according to Department of Energy (DOE) Policy 455.1, *Use of Risk-Based End States*, the *DOE End State Vision Guidance*, and the *DOE End State Vision Guidance Clarification*.

The *SRS End State Vision* depicts appropriately protective and sustainable site conditions by which current regulatory and other parameters can be described, evaluated, and contrasted. It is intended to support informed decision making regarding responsible site cleanup.

The following are the information/data sources used in the development of the *SRS End State Vision*:

- *SRS EM Program Performance Management Plan* (PMP) – describes the strategy to achieve accelerated cleanup and risk reduction at SRS. It includes the scope, schedule, cost, roles and responsibilities, milestones, end state descriptions, performance metrics, and actions required to achieve cleanup by the end of FY 2025.
 - *DOE Report to Congress: Planning For The Future, An Overview of Future Use Plans at Department of Energy Sites* – describes the future use planning process and the future use plan for SRS. It represents the formal response to the National Defense Authorization Act (NDAA) for Fiscal Year (FY) 1997 requirement to submit future use plans to Congress. The *SRS Future Use Plan* is the result of a series of public meetings and the SRS planning process. It provides the land use requirements for the Comprehensive Environmental Response, Compensation and Liability Act (CERCLA) remedy selection in the cleanup process.
 - *SRS Long Range Comprehensive Plan* -- describes the framework for integrating SRS missions and infrastructure with ecological, economic, cultural and social factors in a regional context.
 - *SRS Ten Year Site Plan* – provides a comprehensive and integrated plan for all missions and programs at SRS. It addresses SRS programs' technical requirements, performance measures, budget, and cost projections within the 10-year window and ensures the facilities and infrastructure assets are of sufficient capacity and condition to accomplish planned SRS missions and programs.
 - *SRS Strategic Plan* – updates SRS vision and strategic goals in partnership with site
-

-
- contractors and support agencies in achieving the DOE goals of: Nuclear Weapons Stockpile Stewardship, Nuclear Materials Stewardship, and Environmental Stewardship.
- *Federal Facility Agreement (FFA)* – directs the comprehensive SRS remediation through an agreement among United States Environmental Protection Agency (USEPA), South Carolina Department of Health and Environmental Control (SCDHEC) and DOE, as required by the CERCLA and the Resource Conservation and Recovery Act (RCRA).
 - *Site Treatment Plan* – plans for the treatment capacities and technologies to treat mixed waste as required by RCRA and the Federal Facility Compliance Act. The plan is to be reviewed by SCDHEC, in consultation with the USEPA, each year.
 - *DOE Savannah River Operations Office (SROO) Comprehensive Cleanup Plan* – advances the SRS area closure approach by presenting the current or identified scope of SRS environmental restoration and deactivation and decommissioning projects in the schedule sequence to meet the requirements to achieve an Area Record of Decision (ROD) that documents the complete cleanup of an area.
 - *Safety Analysis Reports* – document the adequacy of a safety analysis for a nuclear facility to ensure that the facility can be constructed, operated, maintained, shut down, and decommissioned safely and in compliance with applicable laws and regulations.
 - *Environmental Impact Statements (EIS)* – describe actions that may significantly affect the quality of the human environment as required under the National Environmental Policy Act (NEPA). The EIS requirement includes the public in the federal agency decision-making process. Major actions generally are those actions that require substantial planning, timing, resources, or expense.
 - *Environmental Information Documents* – provides environmental information/data developed as background technical documentation for the DOE's Environmental Impact Statement on waste management activities at SRS.
 - *Administrative Record File* – maintains the documents for the complete Administrative Record, post-Record of Decision primary and secondary documents and reports for the DOE-preserved repository, throughout the duration of the FFA, and for a minimum of 10 years after the termination and satisfaction of the FFA,.
 - *SRS EM Integrated Deactivation and Decommissioning Plan* – communicates key elements of the scope for SRS closure; provides a tool for planning, implementing, and decommissioning of EM facilities and waste sites; and serves as a repository of supporting information for closure of facilities, waste tanks, and waste sites in hard copy and electronic form.
 - *Annual Environmental Reports* – present summary environmental data that characterize site environmental management performance; confirms compliance with environmental standards and requirements; highlights significant programs and efforts; and assesses the impact of SRS operations on the public and the environment.
 - *Land Use Controls Assurance Plan for the SRS* – assures long-term effectiveness of land use controls (LUC) at contaminated SRS waste units listed in the FFA undergoing remediation pursuant to CERCLA and/or RCRA, for which LUCs were selected as part of the final corrective/remedial action.
 - *Savannah River Site's Cold War Built Environment Cultural Resources Management Plan* – applies only to the Site's Cold War National Register of
-

Historic Places (NRHP)-eligible historic properties and outlines the vision, strategies, and planning for the evaluation, management, mitigation, and preservation of these properties. It does not pertain to cultural resources associated with the site's pre-history and pre-Federal history.

1.2 Organization of the Report

Chapter 1, *Introduction*, briefly discusses relevant background objectives and drivers for the *SRS End State Vision*; provides a user's guide that describes the relationship and integration of appropriate text and tables, briefly discusses status of the site's mission and cleanup strategy. Chapter 2, *SRS Regional Context End State Vision Description*, addresses the SRS in a regional context by defining the human and ecological land use surrounding the SRS. Chapter 3, *Savannah River Site Specific End State Vision Description*, provides information on the physical and surface interface, land use and ownership and site demographics at the overall site level. Chapter 4, *Hazard Specific Discussion*, provides hazard-specific discussion, which are presented at the individual watershed and area scale. Appendix A, *Regional and Site Maps*, supports the information and data presented in Chapter 2 and 3. Appendix B, *Alternative End States and Recommendations*, provides SRS Alternative End States and recommendations, with subsequent appendices providing complimentary information relative to the *SRS End State Vision* objectives. Appendix C, *Regional Planning Initiatives*, describes the regional planning initiatives developed with the Central Savannah River Area (CSRA) planners. Appendix D, *Regulatory Support and Agreements*, provides regulatory support documents and agreements. Appendix E, *Long Term Stewardship*, is a brief summary of long-term stewardship. A list of references is provided in Appendix F, *References*. Appendix G, *Land Use, Risk and Cleanup Decision Process*, gives a summary of land use, risk, and

how the cleanup decision process works. Public comments from previous versions of the *SRS Risk-Based End State Vision* and responses to those comments are provided in Appendix H, *Public Comment Matrix*. Appendix I, *Watershed Conceptual Site Models and Hazard Tables*, Appendix J, *Area Conceptual Site Models and Hazard Tables*, and Appendix K, *Conceptual Site Models for Typical SRS Hazards (Soil, Groundwater, EM Facilities, LRW Tanks)*, support the information and data presented in Chapter 4.

Appendix K, *Conceptual Site Models for Typical SRS Hazards (Soil, Groundwater, EM Facilities, LRW Tanks)*, is unique to the hazard classes of inactive waste units and EM facilities. Due to the large number and similarities of hazards that make up these hazard classes, "typical" hazard type Conceptual Site Models (CSMs) have been developed to represent multiple and similar waste units or EM Facilities.

The *SRS End State Vision* (ESV) fully meets the intent of the guidance; however, a tailored approach has been implemented to meet the data requirements for the *End State Vision*. The ESV is designed to define and categorize hazards in such a manner that all stakeholders can understand the hazard and what actions are being taken to reduce and/or eliminate the hazard.

SRS hazards are organized into five major classes. The five classes are further subdivided into fourteen categories:

- **Nuclear Materials:** plutonium, uranium, spent nuclear fuel, and tritium.
- **Radiological Waste:** Liquid radioactive waste (LRW), Transuranic (TRU) waste, Low Level Waste (LLW) and Low-Level Mixed Waste (LLMW).
- **Non-Radiological Waste:** hazardous and sanitary waste
- **Inactive Waste Units:** contaminated soil and groundwater

- **EM Facilities:** nuclear, radiological, other industrial facilities and LRW tanks

Hazard types are identified individually and physically depicted/described in the following geographic hierarchy:

1. Site
2. Watershed/Integrator Operable Unit (IOU) (see IOU definition in Chapter 4)
3. Area

Due to the large SRS land area, large number of SRS hazards and the associated complexity in depicting current state, planned end state and alternative end states for the hazards, Figure 1.1 is provided to guide the reader through the applicable text, tables, and figures.

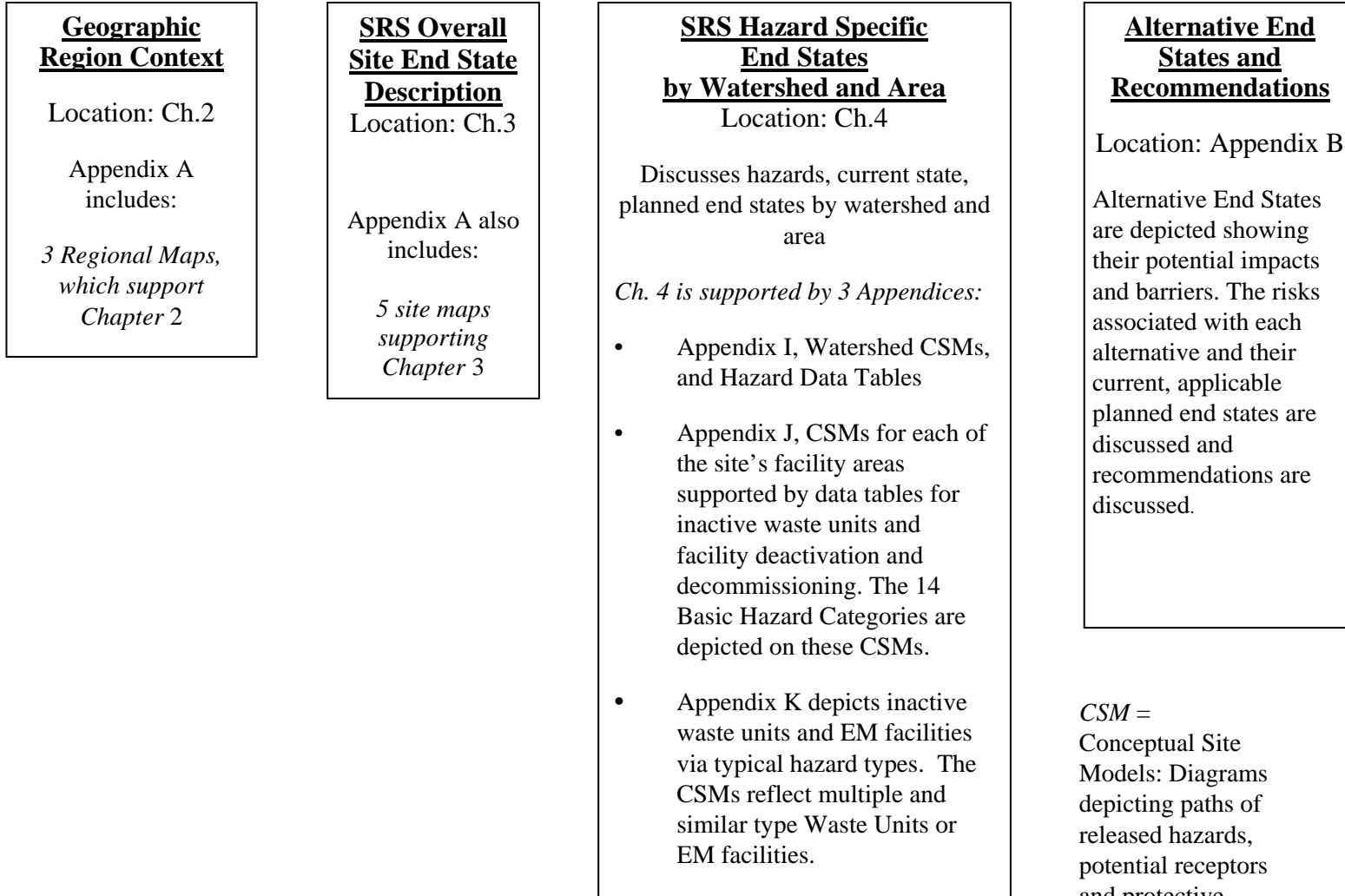

Figure 1.1 Basic Document Organization

1.3 Hazard and Risk Relationship

Risk is the chance of harm or loss. In addition, the concept of risk is used by a wide diversity of disciplines for a wide variety of objectives (e.g., public health, worker health, ecological, safety, economic, project related, etc.). This can easily lead to confusion. In the cleanup context, environmental laws are designed to protect humans and the environment from hazards and restore the environment to ensure human and ecological health is within an acceptable risk range. For a risk to exist, a hazard must be present, and there must be an exposure pathway to a receptor. Risk assessment is a function of the type of land use, who is exposed (what kind of receptor) and how the receptor is exposed (pathway).

Hazards are managed based on one of two approaches; the hazard is contained or the hazard has already been released to the environment. These two approaches are referred to as “hazard contained” and “hazard released.”

Appendix G provides additional information regarding risk and the SRS cleanup decision process for hazards released into the environment.

1.3.1 Hazard Released

Since there is no such thing as “zero risk,” Congress has defined the acceptable level of risk for cleanup of hazards. For chemicals that produce cancer (carcinogens), the residual hazard is limited to an excess lifetime cancer risk (ELCR) within 1 to 100 in a million. This is sometimes expressed as a risk range of “ $10E^{-4}$ to $10E^{-6}$.” If the residual risk is $10E^{-6}$, then for every 1,000,000 people that could be exposed, one extra cancer case may occur as a result of exposure to the contaminated hazard site. One extra cancer case means that one more person could get cancer than would normally be expected from all other causes. For $10E^{-4}$ risk,

then there may be one extra cancer cases may occur for every 10,000 people exposed to the hazard site.

For inactive waste unit hazards (surface and groundwater units), the adverse event of a released hazard to the environment has already occurred, and cleanup is required to reduce the risk to legally acceptable levels.

1.3.2 Hazard Contained

Nuclear material, waste (radiological and non-radiological) and EM facility hazards have controls in place to contain and disposition the hazards to avoid an event that would allow a hazard exposure pathway to a receptor which could adversely impact human health or the environment. Controls are determined by assessing and characterizing the hazard and analyzing potential accident scenarios and associated consequences through various risk assessment processes (Performance Risk Assessments and Safety Basis Documents).

1.4 Site Missions

SRS was established to produce plutonium and tritium for national defense and additional special nuclear materials for other government uses and for civilian purposes. When the Cold War ended in 1991, DOE responded to changing world conditions and national policies by refocusing its mission to cleanup of the nuclear waste and environmental contamination created during production.

SRS’s current mission is to fulfill its responsibilities safely and securely in the stewardship of the nation’s nuclear weapons stockpile, nuclear materials, and the environment. These stewardship areas reflect current and future missions to:

- Meet the needs of the enduring U.S. nuclear weapons stockpile

- Store, treat, and dispose of excess nuclear materials safely and securely
- Treat and dispose of legacy wastes from the Cold War and clean up environmental contamination.

“Stewardship” in the context of SRS’s mission is defined as “responsibility for the careful use of money, time, talents, and other resources, especially with respect to the principles and/or needs of a community.”

The site’s Nuclear Weapons Stewardship mission emphasizes the science-based maintenance of the nuclear weapons stockpile. SRS supports the stockpile for ensuring the safe and reliable recycle, delivery, and management of tritium resources and by contributing to the stockpile surveillance program.

The Nuclear Materials Stewardship mission is to manage excess nuclear materials, including the transportation, stabilization, storage and disposition to support nuclear nonproliferation initiatives. Primary nuclear materials in this program include components from dismantle weapons, residues from weapons processing activities, spent nuclear fuel and other legacy materials.

The Environmental Stewardship mission involves the management, treatment, and disposal of radioactive and non-radioactive waste resulting from past, present, and future operations. This stewardship includes the restoration of the environment impacted by site operations.

Of the 310 square miles or 198,000 acres the SRS covers, approximately 5,000 acres (~2.5% of the site) are defined as inactive waste units. In addition, approximately 5,000 acres (~2.5% of the site) outline the boundaries of the groundwater contaminant plumes defined within the site. The primary contaminants that are of

concern in the groundwater at SRS are volatile organic compounds and tritium.

Additional details on the site’s missions can be found in the *Savannah River Site Ten-Year Site Plan* (WSRC-RP-2004-00637) and the *2004 Environmental Management Program Performance Management Plan* (April 2004).

Future mission activities also include the processing of plutonium, the radioactive material that fueled one of the bombs that ended World War II and was a component of the warheads of the Cold War. DOE has indicated that the following facilities may be built at SRS:

- A pit disassembly and conversion facility
- A mixed oxide (MOX) fuel fabrication
- An immobilization facility to immobilize the remaining plutonium oxide in ceramic material

Other potential new missions for SRS include:

- Modern Pit Facility (MPF)
- Hydrogen Technologies.
- Nuclear Training Center
- Commercial Nuclear Power Generating Plant

SRS is supporting a variety of national programs in number of areas, e.g., National Homeland Defense, Nuclear Forensics, Fusion Energy, etc. Many of these programs have potential for growth at SRS with reuse of existing facilities or installation of new facilities. Additional details can be found in the *Savannah River Site Ten-Year Site Plan* (WSRC-RP-2004-00637.)

1.5 Status of Cleanup Program

1.5.1 Cleanup Accomplished

The SRS cleanup program has been actively reducing risk across all components of the EM Program. Protecting human health and the environment is a fundamental priority of the cleanup program, and SRS efforts to reduce risk

in order to maintain this protection have resulted in noteworthy accomplishments. In the mid-1990s, the site began to emphasize cleanup completion, which resulted in the realization of significant cleanup results. This shift enabled SRS to achieve increased risk reduction. Today, risk reduction is achieved through a variety of techniques, including waste and materials stabilization and processing; waste removal and/or disposal; source term remediation or immobilization; mitigation of contamination transport and, minimizing waste generation.

For example, early in the Liquid radioactive waste (LRW) Program, it was recognized that some LRW sludge, a very high-source-term material, was contained in single-walled underground storage tanks, with a real threat that the sludge could leak from the tanks into the surrounding soil, which would contaminate that soil and potentially the groundwater under the tanks. In the late 1980s, operations were begun to start removing this sludge and place it into double-walled tanks and was prepared for vitrification through the Defense Waste Processing Facility (DWPF). LRW canister production began in DWPF in 1996, and through June 2004, 1900 canisters have been produced. Another LRW risk reduction effort was the closing Tanks 17 and 20 in 1997. These tanks were filled with grout, thereby, removing any threat these tanks posed to workers and the surrounding environment.

Considerable progress has been made toward aggressively “working off” the inventory of the various solid wastes (SW) that have been generated through years of SRS operations. Dispositioning these wastes effectively reduces the risk of release that could occur with their continued storage. Transuranic (TRU) waste resulting from nuclear material stabilization activities has been stored at SRS for years. The TRU waste poses a significant risk due to waste characterization uncertainties and the potential for the build-up of hazardous gases that could

lead to an environmental release of contamination. SRS has been characterizing and processing TRU waste in order to ship this waste to the Waste Isolation Pilot Plant (WIPP).

In the 1990s, the SW program’s focus broadened to include the reduction of the amount of waste that was being generated.

Accelerated cleanup and risk reduction are being achieved in the Nuclear Materials Management (NMM) Program through the stabilization and processing of nuclear materials, many of which were designated as at-risk materials in recommendations developed by the Defense Nuclear Facilities Safety Board (DNFSB). Milestones established in the *SRS Implementation Plan* responding to recommendations from the DNFSB have, in most cases, been achieved or accelerated.

SRS continues to receive spent nuclear fuel (SNF) from foreign and domestic research reactors in support of non-proliferation objectives to keep SNF secure, safely stored and protected. SNF is being consolidated to a central storage location in L Area. To date, K Area Disassembly Basin and the Receiving Basin for Off Site Fuel (RBOF) have been de-inventoried of its SNF and are either deactivated or are being deactivated. Currently, the DOE is finalizing their selection of the disposition technology to be used for SNF inventories across the DOE complex. All SNF stored at SRS is projected to be treated, packaged and shipped to the repository by the end of FY2020.

The Soils and Groundwater Project (SGP) is focusing on cleaning up contamination that exists in the environment to protect the public, the SRS workers and the environment. The cleanup methods focus on treating or immobilizing the source of the contamination to mitigate contamination transport through soil and groundwater, both on SRS and offsite, and cleaning up or slowing the movement of

contamination that has already migrated to the environment.

Throughout the SGP there has been continuous improvement in technologies, regulatory processes and project management. In recent years, remediation methods have been evolved to more efficient and cost-effective approaches, such as bioremediation, monitored natural attenuation, barometric pumping, solar-powered microblowers, and dynamic underground steam stripping. In addition, immobilizing source term material with impermeable clay caps or/and grouting waste in place are a cost-effective way to fix contamination in place while minimizing the potential to affect worker health and safety.

In the Deactivation and Decommissioning (D&D) Program, the “Assets-for-Services” concept was used successfully to reduce the footprint of facilities by approximately 71,000 cubic feet. This was accomplished for less than \$1.1 million, a cost saving of approximately \$10 million, when compared to the estimated cost of \$11.1 million to perform the work using traditional D&D methods.

SRS has initiated deployment of the Area Completion Process, (see Figure 1.2, *Critical Decision Path to Area Completion*) which uses a systematic approach to complete cleanup work at SRS, area by area. A necessary part of this process involves integrating D&D and SGP scopes. (See Figure 1.3, *Basic Area Completion Process*.) The Area Completion Process addresses larger groupings of waste units and D&D facilities within a facility area, allows for efficiencies in coordinated sampling and remediation activities, and provides for a comprehensive area strategy with one end state.

In support of this closure strategy, SRS has incorporated the Area Completion Process into

its Federal Facility Agreement (FFA) with state and federal regulatory agencies. Appendix E of the FFA contains Soil and Groundwater lifecycle cleanup milestones from FY 2006 through 2025, the time frame in which SRS cleanup is to be completed. Appendix E defines waste units that are included in each of the 14 Area Completions and includes some D&D facility remnants in T and M Areas, the first areas scheduled for closure. Based on the new generic Area Completion schedule (see Figure 1.2, *Critical Decision Path to Area Completion*), the appendix starts an area completion each year, through 2016. This optimizes resource planning by establishing a steady level of work.

The generic Area Completion Schedule defined in Appendix E, by necessity, aligns operations, D&D, and soil and groundwater schedules. SRS focuses on cleaning up surface unit contamination to minimize contaminant migration to the groundwater, while maintaining groundwater control through ongoing monitoring and efficient remediation. Specific decisions associated with the remediation and future land use of each area will be determined on an area-by-area basis in conjunction with review by the public and the approval of appropriate regulatory agencies.

The first SRS Area Completion, T Area, is scheduled for completion in 2006. Supported by the FY 2005 Appendix E and the new area completion approach, DOE, EPA and SCDHEC are poised to achieve further efficiencies in the SRS cleanup program and will complete SRS cleanup by 2025.

Table 1.1, Gold Metrics, provides a list of EM performance metrics being tracked by DOE to measure progress towards accomplishing final end states for certain nuclear materials, wastes, inactive waste units, and EM facilities.

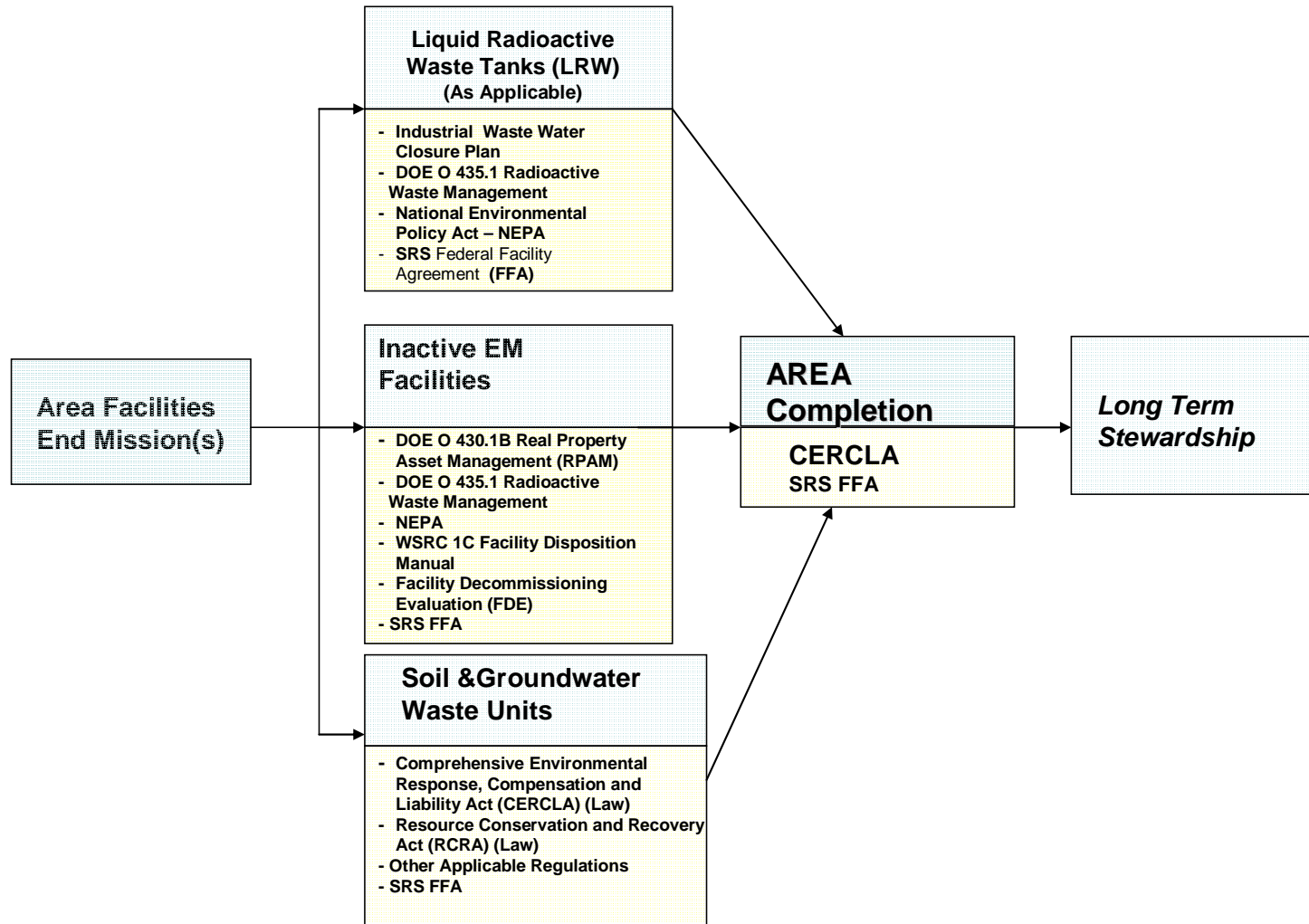

Figure 1.2 Critical Decision Path to Area Completion

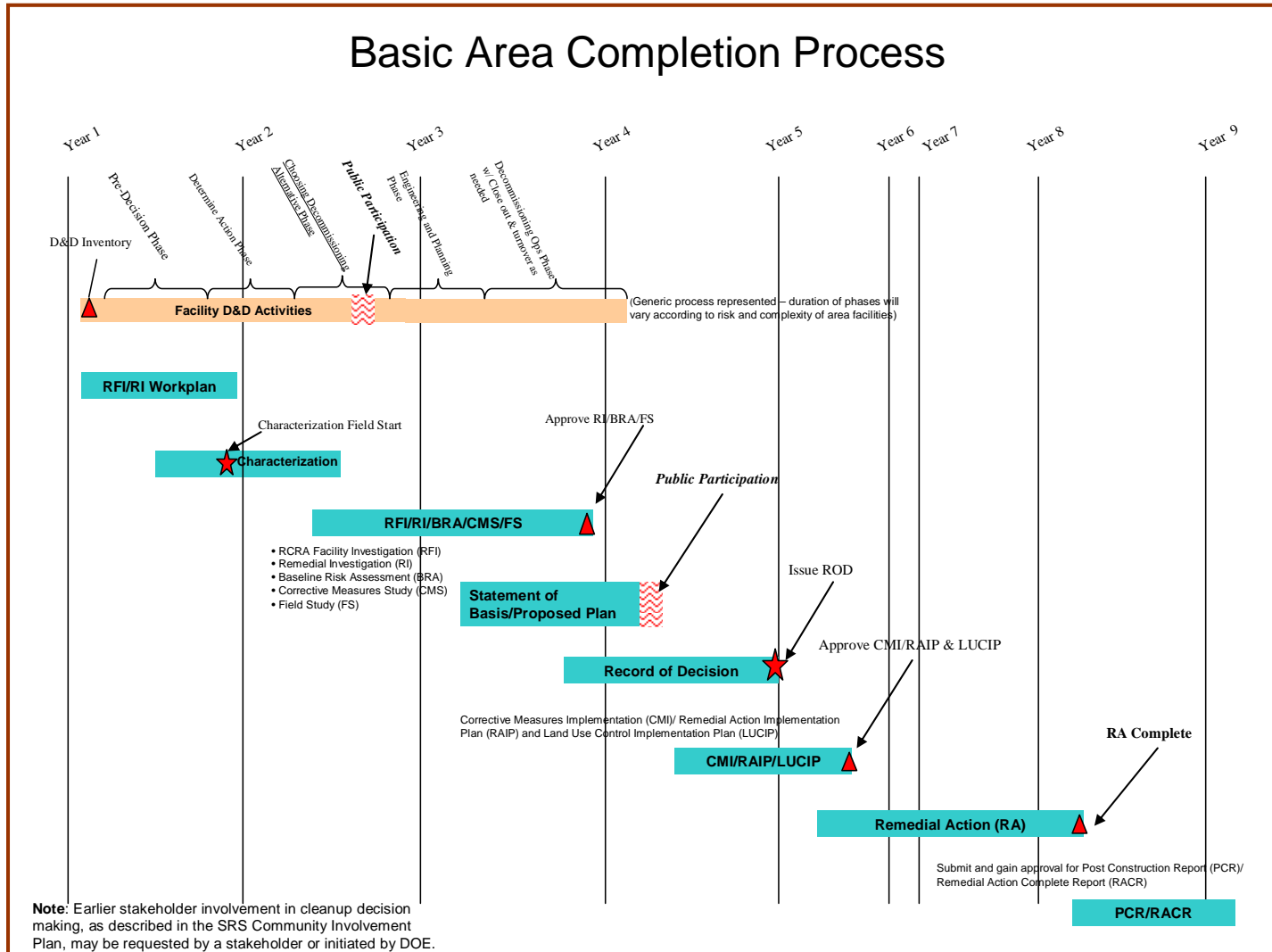

Figure 1.3 Basic Area Completion Process

Table 1.1 Gold Metrics (as of 6/30/05)

Performance Measure	Unit	Actual Completion	Life Cycle Scope*	% Complete
Nuclear Materials				
Plutonium packaged for long-term disposition	containers	919	1049	87.61%
Enriched Uranium packaged for disposition	containers	1487.227	2,809	52.95%
Plutonium/Uranium residues packaged for disposition	kg bulk	428.061	414	103.40%
Depleted Uranium & Uranium packaged for disposition	MT	7,397	23,182	31.91%
Spent Nuclear Fuel packaged for disposition	MTHM	2.822	36	7.84%
Radioactive Waste				
Liquid radioactive waste packaged for disposition	containers	1907	5060	37.69%
Liquid Waste eliminated	k-gallons	0	33,090	0.00%
Liquid Waste tanks closed	tanks	2	51	3.92%
Low Level Waste/Low Level Mixed Waste disposed	cubic meters	76,923	294,211.0	26.15%
Transuranic Waste disposed	cubic meters	3558	15,326	23.22%
Safeguards and Security				
Material Access Areas	areas	0	4	0.00%
Environmental Management Legacy Facilities				
Nuclear Facilities completions	facilities	7	195	3.59% %
Radioactive Facilities completions	facilities	1	40	2.500%
Industrial Facilities completions	facilities	156	780	20.00%
Inactive Waste Unites				
Remediations complete **	inactive waste units	323	515	62.72%
*Information from the DOE-SR database for Gold Metrics. Lifecycle quantities will be updated as a result of additional quantities from Rocky Flats, Hanford, and inclusion of additional waste from decommissioning activities				
**Five of the 323 Release Site Completions were reopened for additional characterization during FY03, per regulatory agency request.				

1.5.2 End State Vision Summary

The SRS Cleanup Reform Vision is to complete the EM Closure Project by 2025.

The EM Closure Project is scheduled for completion by 2025, at which time EM will have completed its mission at SRS and will not require the use of any facilities. SRS will continue under federal control with restricted recreational and industrial/maintenance worker use, with no residential use. Production areas with no reuse plans will be cleaned to an industrial maintenance criterion. All nuclear materials and spent nuclear fuel will be dispositioned by reuse or disposal. The end state for the five SRS production reactors and three chemical separations plants, which includes the liquid radioactive waste (LRW) vitrification facility, is in-situ disposal unless reused to support other long-range federal missions at SRS or designated for historical preservation.

Other industrial, radiological, and nuclear facilities will be demolished to a slab or will be disposed in situ. LRW will be vitrified as a prelude to geologic disposal and the 51 storage tanks will be emptied and filled with grout. Remediation of the 515 inactive waste units, which include contaminated groundwater will be finished but may require monitoring in perpetuity, per regulators' requirements, to verify that cleanup has been achieved.

Chapter 4 addresses current status and the FY 2025 planned end state in more detail in an integrated manner with mission, facility and land use planning.

Figure 1.4, *ESV Area Completion Plan*, depicts the integrated regulatory strategy and area closure concept. It illustrates the cleanup and closure order schedule for the SRS industrial areas and the IOU completion.

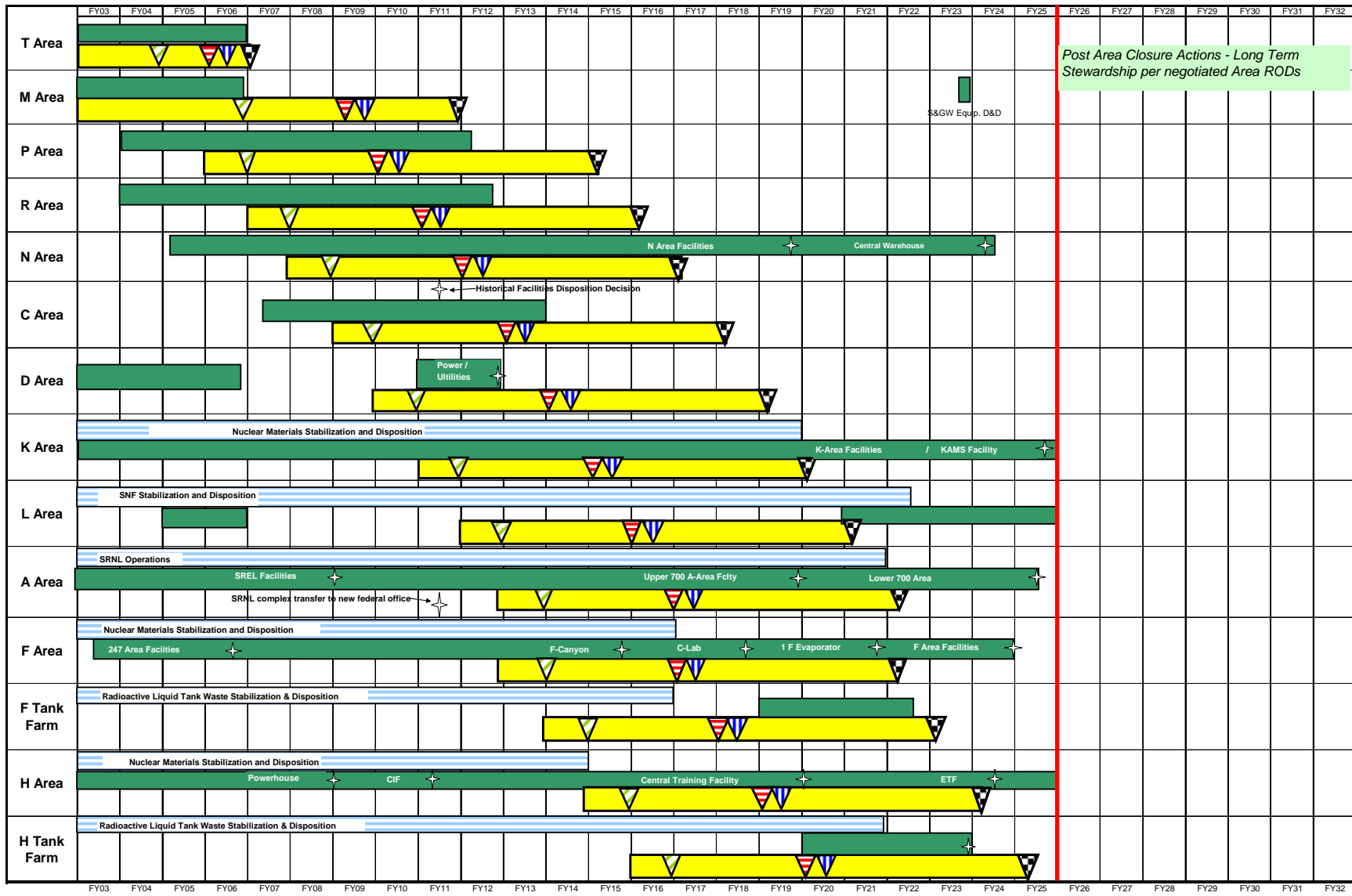

Legend Operations Deactivation and Decommissioning (D&D) Soil and Groundwater Remediation [Rev.1 Appendix E FY2005 (3/7/05) except T and M Areas]

★ Key completion (Dates Reflect 2005 Pjct Mngmnt Plan) ▽ Field Start ▽ Issue Record of Decision (ROD) ▽ Remedial Action Start ▽ Submit Post Construction Report (PCR)

Figure 1.4 ESV Area Completion Plan

1.6 National Environmental Research Park

The Savannah River Site was designated a National Environmental Research Park (NERP) by the Atomic Energy Commission (AEC) in 1972. It was the first of seven current DOE sites to be so designated. NERPs were established to provide large tracts of land where the effects of human activities, particularly energy-related industrial activities, on the environment could be studied.

NERP activities at SRS have included:

- Research on energy activities, ecosystem dynamics, contaminant transport, bioremediation, model development, and theory validation
- Long-term monitoring of climate, flora, and fauna
- Public information and education
- Undergraduate and graduate training in environmental research
- Collaboration with local, regional, private, and government organizations involved with the environment
- Inventory of biodiversity, threatened and endangered species

SRS presents an ideal situation for achieving these objectives because its vast size makes large-scale environmental research and monitoring projects possible. Also, SRS has been under strict federal control for over fifty years, and during that time has been spared the effects of any significant activities other than those of DOE and its predecessor agencies. This isolation from development and casual public encroachment has preserved the greatest diversity of flora and fauna; including native species and threatened, endangered, and sensitive organisms; of any area in the southeastern coastal plain, allowing the study of the environment in a natural, undisturbed state.

It also provides a well-documented land use history, making long-term studies possible.

The entire SRS is a NERP. However, thirty DOE Research Set-Aside Areas (over 14,000 acres in all), representing typical habitats, are protected from site operations and not actively managed so that they remain undisturbed. The Set-Aside Areas serve as natural reference areas or “controls” for environmental research, and provide important baseline information for evaluating the effects of human activities. The Set-Asides are overseen by a Task Group comprising DOE, the South Carolina Department of Natural Resources, the Savannah River Ecology Laboratory, the U.S. Forest Service-Savannah River, the Savannah River National Laboratory, and Westinghouse Savannah River Company.

While there have been environmental impacts from SRS operations, the virtual absence of other human impacts and vast expanses of land undeveloped for the past 50 years (over 90 percent of SRS) provide an ideal outdoor laboratory for studying them. Along with DOE, scientists from other government agencies, universities, and private foundations have been able to study radioecology, industrial ecology, successional ecology, cleanup efficacy (including the balancing of contaminant-driven remediation with the environmental damage that cleanup can cause) and long-term protectiveness, and other topics under these unique conditions. Their research has led to the development, demonstration, and evaluation of new ways to monitor, protect and restore the environment at SRS and elsewhere.

Consistent with the site’s NERP designation, environmental study and research and development will continue at SRS. DOE’s stakeholder-supported intention to retain control of SRS indefinitely makes the site even more

valuable as an ecological laboratory for studying restoration.
the environment and its protection and

2.0 SRS REGIONAL CONTEXT END STATE VISION DESCRIPTION

2.1 Physical and Surface Interface

See Appendix A, Regional and Site Maps, for maps that support this SRS Regional Context End State Vision Description.

2.1.1 Administrative

SRS is located in the Central Savannah River Area (CSRA), which contains nine counties in South Carolina (Aiken, Allendale, Bamberg, Barnwell, and Edgefield) and Georgia (Burke, Columbia, McDuffie, and Richmond). (See Map 2.1., Regional Physical and Surface Interface Map – Current State in Appendix A, *Regional and Site Maps*.) While there is no precise definition of the boundaries of the CSRA, for the purpose of this document, CSRA refers to those counties in which activities, commerce, and population would be seriously affected if a facility of SRS's magnitude did not exist.

The site's southwestern boundary is formed by the Savannah River, a historical transportation corridor and the recipient of most of the area's tributaries. The site includes portions of Aiken, Allendale, and Barnwell counties.

The Savannah River Site (SRS) is owned by the Department of Energy (DOE), a federal agency. Adjacent land is owned by private property owners, such as individual and corporate landowners.

Major governmental jurisdictions in the area include: Aiken, Allendale, Bamberg, Barnwell, Bath, Belvedere, Blackville, Denmark, Fairfax, New Ellenton, North Augusta, and Williston in South Carolina; and Appling, Augusta, Evans, Grovetown, Martinez, Thomson, and Waynesboro in Georgia.

Other federal agencies also have an impact on the region such as the U.S. Department of Agriculture, the Agricultural Services Center,

USDA United States Forest Service - Savannah River (USFS-SR), the Agricultural Stabilization and Conservation Service, the Farmers Home Administration, and the Natural Resources Conservation Service provide significant support for farmers and farm-related activities. The Departments of Commerce, Defense, Health and Human Services, Interior, Justice, Labor, and Transportation also have offices in the region.

The 50-mile radius, the basis for determining the region, is the geographical area required by the Nuclear Regulatory Commission (NRC) to have a Safety Analysis Report, which must include population information. Only the work force required to accomplish DOE's mission and a restricted number of visitors have "limited access" to the SRS.

2.1.2 Watersheds

A watershed is an area that drains to a common waterway, such as a stream, lake, estuary, wetland, or the ocean. For the past five years, the Environmental Protection Agency (EPA) has joined others to promote the watershed approach nationally to further restore and maintain the physical, chemical and biological quality of our nation's waters. In particular, EPA has been working with federal, state, and tribal governments to tailor activities and services to local watersheds and their groups.

The watershed approach is made up of three key components:

1. Geographic Focus: Watersheds are nature's boundaries. They are areas that drain to surface water bodies. A watershed generally includes lakes, rivers, estuaries, wetlands, streams, and the surrounding landscape. Groundwater recharge areas are also considered.
 2. Continuous Improvement Based on Sound Science: Sound scientific data, tools, and
-

techniques are critical to the process.

Actions taken include characterizing priority watershed problems and solutions, developing action plans and evaluating their effectiveness within the watershed.

3. Partnerships / Stakeholder Involvement:

Watersheds transcend political, social, and economic boundaries. Therefore, it is important to involve all the affected interests in designing and implementing goals for the watershed. Watershed teams may include representatives from all levels of government, public interest groups, industry, academic institutions, private landowners, concerned citizens, and others.

The CSRA is comprised of 13 watersheds as listed below.

South Carolina Watersheds in the CSRA

Brier
Broad St. Helene
Edisto
Lower Savannah
Middle Savannah
North Fork Edisto
Salkehatchie
Saluda
South Fork Edisto
Stevens

Georgia Watersheds in the CSRA

Brier
Little
Middle Savannah
Upper Ogeechee
Upper Savannah

SRS is comprised of seven smaller watersheds as depicted on Map 2.3, *Regional Watershed Map – Current State* in Appendix A, *Regional and Site Maps*.

2.1.3 Transportation and Infrastructure

South Carolina is serviced by five U. S. primary routes: I-20, I-26, I-77, I-85, and I-95. I-20 is

closest to SRS and is approximately 30 miles from the center of the site. U. S. Highway 278 crosses the northern section of SRS. In addition, U. S. Highway 1 passes through Aiken and Augusta, and U. S. Highway 301 passes through Allendale. Both highways extend to within 20 miles of the center of the site.

Offsite access to SRS is provided by four South Carolina primary roads: SC 125, the main access route from the Augusta/North Augusta/Allendale region; SC 19, which provides access to SRS from the Aiken/New Ellenton region; SC 39, which provides access from the Williston region; and SC 64, which provides access from the Barnwell region.

CSX Transportation and Norfolk Southern Corporation provide railroad service to the CSRA. Both of these railroads have access throughout the United States, Canada, and Mexico.

Commuter air service and jet service to major United States cities is provided by two commercial airports in the vicinity of SRS. Bush Field in Augusta is approximately 21 miles from the site; Columbia Metro Airport in Columbia, South Carolina, is approximately 56 miles away from the site.

There are approximately 120 public water systems in the region. All of the county and municipal water supply systems obtain their water from the Dublin/Midville aquifer system. The region has 15 major public sewage treatment systems.

For regional landfill needs, the Three Rivers Solid Waste Authority (TRSWA) is the mechanism to meet the requirements of the State Solid Waste Policy and Management Act. TRSWA provides waste management services to local governments in an area consisting of Aiken, Allendale, Bamberg, Barnwell, Calhoun, Edgefield, McCormick, Orangeburg, and Saluda counties. This regional landfill site assists these

counties in the placement of GOFER (Give Oil for Energy Recovery) sites, white goods (metal) cleanup and removal, recycling assistance, and the cleanup of waste tires. The Three Rivers Landfill is located off of Highway 125 on property owned by the Department of Energy at the Savannah River Site, and it is leased to the TRSWA. Administration and management of the TRSWA is provided by the Lower Savannah Council of Governments. In addition, there are nine local sanitary landfills in the area.

Since 1999, 35% of South Carolina's electric power has been generated by nuclear reactors; 33% is by coal; 19% by hydroelectric, with some electricity generated by gas and petroleum power plants. In the South Carolina counties located near the site, the South Carolina Electric and Gas Company (SCE&G) provides power. The nearest power generation facility to SRS is in Beech Island, SC. The Erquhart Station combines cycle combustion and coal-fired steam turbines to produce power for SCE&G.

As of 2002, for Georgia, 39% of the power is generated by coal power plants; 12% by nuclear power plants; 11% by hydroelectric power plants with balance of electricity is generated by gas and petroleum power plants. Plant Vogtle, located across the Savannah River in Georgia, is a nuclear power plant owned by Georgia Power Company.

Below is a list of the interstate natural gas pipelines located in the CSRA:

- Dixie Pipeline
- South Carolina Pipeline Corporation
- Southern Natural Gas Company

2.1.4 Surface Contamination

The Savannah River is used primarily to support industry, recreation, and natural habitat development. This river is fed by numerous streams, including five major SRS streams: Upper Three Runs, Fourmile Creek, Pen Branch, Steel Creek, and Lower Three Runs Creek. SRS

is situated in three major resource areas: the Southern Piedmont, the Carolina and Georgia Sand Hills, and the Atlanta Coastal Plan. These characteristics are typical of land forms that resulted from of historical marine sediment deposits in central and eastern Georgia. There are no mountains in the general area.

Because of the land's characteristics and the site's proximity to the Savannah River, soil conservation, flood plain management, and wetland issues play a large part in local planning. For a long time, area residents have recognized the value of the Savannah River and its environs, and much of their recreational life centers around water activities. Thurmond Lake (1200 miles of shoreline), other lakes and the Savannah River offer swimming, fishing, camping, water skiing, boating and hiking.

To maintain water quality for industrial, recreational, and residential use, development plans and monitoring programs are essential for both the functional integrity of the area and the safety, health, and property of the citizens. The South Carolina Department of Health and Environmental Control (SCDHEC) is responsible for SRS's monitoring programs. However, the State of Georgia has raised concerns that groundwater contaminated with tritium might migrate from SRS through aquifers underlying the Savannah River into Georgia by what is referred to as trans-river flow. SRS sampled wells in Burke and Screven counties in 2000, and SRS and the Georgia Department of Natural Resources conducted joint sampling in Burke and Screven counties in 2001 and 2002. The overall trend of the data showed a continual gradual decline in tritium levels.

Both the Savannah River and aquifers in the area provide an abundant supply of water. Groundwater is used throughout the CSRA as a domestic, municipal, industrial, and agricultural water supply. The Savannah River is used as a

drinking water supply for some residents downriver of SRS. The City of Savannah Industrial and Domestic Water Supply Plant intake at Port Wentworth is approximately 130 river miles from SRS; the Beaufort-Jasper Water Treatment Plant intake, near Beaufort, South Carolina, is approximately 120 river miles from SRS.

Most of the domestic supply of groundwater within the CSRA is produced from the Floridian aquifer system, while the remaining supplies are produced primarily from the Cretaceous age Dublin/Midville aquifer system. The groundwater production from the prolific Dublin/Midville aquifer system is about 50 million gallons per day and satisfies SRS industrial uses and drinking water consumption for the site workforce.

2.1.5 Hazard Areas of Concern

There are four National Priority List (NPL) or Superfund sites in the CSRA as shown below:

Name	Listed	Delisted
Savannah River Site	11/21/89	2025
Helena Chemical Company (Allendale County, SC)	2/21/90	N/A
Shuron Plan (Barnwell County, SC)	12/23/96	N/A
Monsanto Corporation (Richmond County, GA)	9/21/84	3/9/98

Table 2.1 CSRA National Priority List Sites

Local concerns for hazards mainly consist of pollution from local industries into the air and/or the Savannah River. (See Section 2.2.1, Land Uses for more details.)

2.1.6 Differences Between Current State and 2025 end State

There are no known major differences between the current regional state and the year 2025 in

the areas of administration, transportation and infrastructure, surface contamination or hazard areas of concern.

2.2 Human and Ecological Land Use

2.2.1 Land Use

Land within the CSRA centers around residential, industrial, commercial, transportation, recreation, and agricultural categories. Upland pine and wetland forests comprise a large percentage of the area. Nonforested wetlands occur primarily along Thurmond Lake and the Savannah River.

Various industrial, manufacturing, medical, and farming operations are conducted near the site. Major industrial manufacturing facilities in the area include textile mills, polystyrene foam and paper product plants, chemical processing facilities, a commercial, low-level radioactive landfill and a commercial nuclear power plant. A variety of crops is produced on area farms, such as forest products, cotton, soybeans, corn, peaches, grapes, and small grains.

Current major uses for land bordering SRS are shown below. (See Map 2.2, *Regional Human and Ecological Land Use – Current State* in Appendix A, *Regional and Site Maps*.)

- Agriculture – while some livestock, horse farming, and vegetable farming takes place, most of the land is used to produce forest products (for pulp and paper, telephone poles, pine straw)
- Light industry - There is currently one 1,500 acre industrial park adjacent to SRS. Bordering this industrial center is the Duratek Low Level Radioactive Waste Disposal Facility. Also in close proximity is Plant Vogtle, a nuclear power facility, directly across the Savannah River from SRS. To ease the burden of the region, SRS has agreed to permit a solid waste landfill within its borders. This facility, the Three

Rivers Landfill, is operating under the authority of a fifty-year lease administered by the Lower Savannah Council of Governments.

- **Light residential** – Most of housing on this land is associated with agriculture, however some houses and manufactured homes border the site (small neighborhoods or individual homes).
- **Recreation** – Wildlife is plentiful since over 90% of SRS is not used for industrial purposes, thus extensive outdoor sports activities occur next to SRS. These activities include hunting, fishing, hiking and bird watching.

The topography and other existing physical features and conditions of the area greatly influence land development decisions and policies. Because of the soil types and lack of steep slopes, the area is well-suited for both agriculture and urban development.

Manufacturing and government account for the largest portion of employment in the region (44.8 percent). Augusta, the Fort Gordon Military Reservation, and SRS comprise a significant amount of total developed area. SRS's significance as an employer is only second in the region to Ft. Gordon, Georgia, twenty-five miles from the Savannah River Site. However, even with fewer employees, SRS' economic impact is greater. Further, SRS is the largest manufacturing employer in South Carolina.

Forest lands, which dominant land cover in the CSRA, are divided between bottomland hardwoods/deciduous, cypress/tupelo, and pine, which is the most dominant. Although forest lands occur throughout the area, the greatest concentration of pine is in the northwest portion, with hardwood/deciduous and cypress/tupelo forests primarily in stream valleys.

2.2.2 Human Activities

Below are listed the populations of the CSRA counties:

Populations (as of 2001)	
County	Population
<u>South Carolina</u>	
Aiken	143,905
Allendale	11,045
Bamberg	16,393
Barnwell	23,525
Edgefield	24,470
<u>Georgia</u>	
Burke	22,591
Columbia	92,427
McDuffie	21,286
Richmond	198,366

Table 2.2 CSRA County Populations

Unlike many Department of Energy sites, SRS is significantly distant from local populations. SRS is approximately 22.5 miles southeast of Augusta and 19.5 miles south of Aiken, the nearest population centers.

2.2.3 Differences Between Current State and 2025 End State

From extensive discussions and review of draft and final growth management, transportation and economic development plans for the region, SRS planners can say with assurance that there are no major changes which would affect site missions in the next 20 years. While normal growth is expected in metropolitan counties in the region or in the populated regions of counties around SRS, the predominant land uses in the areas adjacent to SRS are expected to remain the same.

Land uses adjacent to SRS are not expected to significantly change during the "twenty year planning timeframe" of the *End State Vision*. A survey of land use plans in the region revealed that unless SRS obtains missions beyond what is

currently planned, there could be a downturn in regional growth. However, within the context of the twenty-year planning timeframe, little change in population, economy, or land is anticipated.

There may be changes in the CSRA due to new transportation corridors, relocation of businesses to the area, etc. However, it is not expected that these activities will significantly affect SRS or the lands adjacent to it. This future growth will occur nearer to population centers (where the markets and workers are) and transportation corridors (to more efficiently move raw materials and finished goods). Finally, because of the abundance of land for growth and other land uses, there is little expectation that SRS land or that near it will be in high demand in the future, thus necessitating new infrastructure and other upgrades in the immediate area.

2.3 Regional Planning Interface

SRS has maintained a close relationship with planning groups, local governments, Councils of Government, and economic development organizations. Site planners have been active in sharing site plans and site planning techniques with these groups. They also provide tours and information and local planners have reciprocated these activities. This close interaction has produced strong cooperation, which has resulted in site and regional planners being current on each other's plans, thus eliminating the need for extensive education whenever new plans are created.

Many regional planning groups were contacted during the development of this End State Vision to assess regional planning activities. These groups include the following:

South Carolina

- Aiken County Planning Department
- Aiken-Edgefield Economic Development Partnership
- City of Aiken Planning Department
- Lower Savannah Council of Governments (Responsible for planning for six counties in South Carolina – all within 70 miles of SRS - Aiken, Allendale, Bamberg, Barnwell, Calhoun, and Orangeburg counties)
- North Augusta Department of Economic Development
- The Southern Carolina Regional Development Alliance (Allendale, Barnwell, Bamberg and Hampton counties), formerly Tri-County Alliance of Allendale, Barnwell, and Bamberg counties)

Georgia

- Augusta-Metro Chamber of Commerce (Includes Columbia and Burke counties)
 - Augusta-Richmond County Planning Department
 - Central Savannah River Area Regional Development Center (supports 14 Georgia counties in the region – including those in the SRS vicinity – Augusta-Richmond, Burke and Columbia)
 - Columbia County Planning Department
-

3.0 SAVANNAH RIVER SITE SPECIFIC END STATE VISION DESCRIPTION

3.1 Physical and Surface Interface

See Appendix A, Regional and Site Maps, for maps that support this Savannah River Site Specific End State Vision Description.

3.1.1 Administrative

The U. S. Government established the Savannah River Site in 1951 for the production and processing of nuclear materials for national defense requirements. The Department of Energy (DOE) manages SRS as a controlled area with limited public access. Located in south central South Carolina, SRS occupies an area of approximately 310 square miles (approximately 800 square kilometers). The Savannah River forms the site's southwestern boundary for 27 miles on the South Carolina-Georgia border. The site includes portions of Allendale, Aiken, and Barnwell Counties

SRS is located approximately midway between South Carolina's piedmont mountains and the Atlantic Ocean. The area is often referred to as the "Sand Hills." Topographic relief at SRS ranges from the long, narrow, steep areas on slopes on the east side of Upper Three Runs Creek and Tinker Creek to the nearly level areas on stream terraces west of SC Highway 125. Elevation ranges from about 420 feet above sea level near the Aiken security gate (northern part of the site) to 70 feet where the Lower Three Runs Creek enters the Savannah River (southeastern part of the site). Most of the drainage from SRS is into the Savannah River; a small portion of the site drains to the Salkehatchie River.

SRS is located on the Atlantic Coastal Plain. The site is covered by hardwood and pine forests and contains lakes, streams, Carolina bays, and other wetlands. The sediments are stratified sand, clay,

limestone, and gravel that dip gently seaward. Some soils in the upland area and along the major streams are well-drained to excessively drained. Soils on bottom land range from well-drained to very poorly drained.

The entire site is designated as a National Environmental Research Park (NERP) used by ecology, forestry, and archaeology groups. Scientific investigators from universities, colleges, and other research organizations use SRS as an outdoor laboratory for the study of the impact of man's activities on the environment.

The original facility layout of SRS was designed to isolate major radioactive operations near the center of the site. This design created a buffer zone that reduces the risk of accidental exposure to the general public and provides security for the site. (See Map 3.1, *Site Physical and Surface Interface – Current State* in Appendix A, *Regional and Site Maps*.)

- Administrative Facilities

The administrative facilities provide office space, general training, and records storage for SRS personnel to conduct normal business operations in support of the site's missions.

A Area and B Area are the primary administrative areas. Administrative facilities are also located in each process area to provide office space for personnel who support the area's specific functions.

Specific details for each site facility area are discussed in Chapter 4, *Hazard Specific Discussion*.

- Non-nuclear Facilities

Non-nuclear facilities include Central Shops (N Area), Heavy Water (D Area), and the Savannah

River National Laboratory (SRNL), formerly the Savannah River Technology Center (SRTC).

N Area houses construction and craft facilities, such as fabrication and welding shops and associated materials in support of construction services. This area also houses the primary warehouse facilities: storage facilities for operations and maintenance materials, including supplies and spare parts.

The Heavy Water facilities in D Area were actually “dual use” because these facilities had significant nuclear and non-nuclear operations. D-Area contained facilities for supporting heavy water coolant/moderator to the reactors. Heavy water purification facilities, an analytical laboratory, and a powerhouse were operating in the area. This area is essentially closed now.

SRNL conducts research, development, and technical support activities. Laboratory operations are conducted in A Area and formerly in TNX, which is under closure. SRNL also has nuclear facilities within A Area.

- Nuclear/Radiological Facilities

Nuclear/radiological facilities at SRS include the following:

Fuel/Target Fabrication (300 Area or M Area) – Formerly metallurgical/foundry facilities for fabricating fuel and target elements for SRS reactors are located in the 300 Area (M Area). Currently this area is undergoing closure activities.

Nuclear Production Reactors (100 Area) – Five reactors for nuclear production originally were built at SRS. All five reactors – C, K, L, P, and R – are classified as surplus facilities and are being evaluated for deactivation and decommissioning. Fuel storage basins in L Reactor contain spent nuclear fuel, awaiting disposition.

Nuclear Materials Processing Facilities (200 Areas) – The processing, stabilization, separation, and recovery of nuclear materials are currently only being performed in H-Area facilities. F-Area facilities formerly performed this work, but most of F-Area is undergoing closure activities. Both F and H Areas have a large, shielded canyon building for processing irradiated materials, glovebox facilities for product finishing, and associated support facilities. In addition, F Area contains an analytical laboratory, the Metallurgical Building, and the Naval Fuel Facility. The facilities are also in the closure process. H Area contains the Receiving Basin for Offsite Fuels, which is also in the closure mode.

Tritium Facilities – Located in H Area, the tritium recycling facilities will continue at SRS and include recycling weapon components for the active stockpile and extraction of tritium from remaining irradiated targets.

Waste Management Facilities – Liquid radioactive waste (LRW) tanks are located in F and H Areas. In S Area, the Defense Waste Processing Facility immobilizes the high activity portion of LRW in glass. The Saltstone Facility (in Z Area) and Effluent Treatment Project are also located in H Area.

Solid Waste Disposal Facility – Solid waste is centrally located in a 195-acre complex in G and E Areas. These facilities store and dispose of radioactive solid wastes and include the Low Level Radioactive Waste Disposal Facility, Transuranic Waste Storage Pads, and the Mixed Waste Storage Buildings.

3.1.2 Watersheds

There are five main watersheds that originate on, or pass through the Savannah River Site (SRS) before discharging into the Savannah River/Floodplain Swamp. These include the following:

- Upper Three Runs Watershed

- Fourmile Branch Watershed
- Pen Branch Watershed
- Steel Creek Watershed
- Lower Three Runs Watershed

All of these watersheds, including the portion of the Savannah River adjacent to SRS, and the stream/wetlands associated with the Integrator Operable Units (IOUs), integrate the potential contamination discharged to surface water or groundwater from SRS operations. The IOUs are the primary pathways for offsite transport of site related contamination.

Additional information for each watershed and associated IOU can be found in Chapter 4, *Hazard Specific Discussion*.

3.1.3 Surface Water

Five major surface water streams feed into the Savannah River: Upper Three Runs Creek, Four Mile Creek (also known as Fourmile Branch), Pen Branch, Steel Creek, and Lower Three Runs Creek.

There are two major artificial bodies of water onsite: Par Pond and L Lake. Par Pond was created in 1958 by the construction of an earthen dam on the Lower Three Runs Creek to provide cooling water for and receive water from the P and R Reactors. The pond covers 2,640 acres and has an average depth of 20 feet.

L Lake, which covers 1,000 acres, was created in 1985 by an earthen dam across Steel Creek to receive cooling water discharges from L Reactor. Water from L-Lake flows to Steel Creek and eventually the Savannah River. Neither Par Pond nor L-Lake is actively used as all SRS reactors are permanently shutdown.

There are also approximately 200 Carolina bays, which are naturally occurring pond formations found in parts of the Southeast United States, are scattered throughout the site, covering a total area of approximately 1,100 acres. These bays

serve as natural habitats for many species of wildlife on the site.

3.1.4 Transportation and Infrastructure

• Transportation

SRS's transportation network consists of approximately 130 miles of primary, 1100 miles of secondary roads, and 33 miles of railroad. The roadways serve to provide access for 20,000 vehicle trips per day (employees driving to and from work and employees driving between site areas), shipment of radioactive and hazardous materials between areas, access to test wells, utility lines, research sites, and natural resource management activities. Westinghouse Savannah River Company (WSRC) maintains primary roads and the USDA United States Forest Service - Savannah River (USFS-SR) maintains the secondary roadways.

The railroads support delivery of foreign fuel shipments, movement of nuclear material and equipment onsite and will support delivery of construction materials for new mission projects. Materials and products transported by rail to or from SRS are shipped by CSX Transportation, which has access throughout the United States, Canada, and Mexico. No tunnels or underpasses restrict the transportation of tall or wide loads.

Both roads and railroads are undergoing evaluation to reduce costs. For example, railroad operation shifts will be reduced from two to one, and WSRC will continue to close unneeded track sections, reduce railroad tie replacements, transfer railroad shipments to road shipments, etc., with plans to abandon SRS railroad system after the last shipment of depleted uranium oxide waste drums to Envirocare, Utah (by Fiscal year [FY] 2006).

- Dams

There are 12 SRS dams, all of which are on the Federal Energy Regulatory Commission (FERC) Dam Inventory list. Two dams (PAR Pond and Steel Creek) are classified as high hazard dams while the other 10 (Pond A, Pond B, Pond C, Pond 2, Pond 4, Pond 5, Skin Face, Old Fire Pond, New Fire Pond and A01 Dam) are low hazard. All ponds are subject to annual inspections by FERC. The function of SRS dams will continue indefinitely to contain radioactive sediments and to support biological, environmental, and ecological research.

- Steam

The SRS Steam System provides process steam to SRS buildings and facilities in support of the site's missions and in compliance with appropriate regulations and standards. Steam is generated and distributed from facilities in A, D and K Areas with a facility in H Area now in standby condition. The D-Area steam generation is run by the South Carolina Electric and Gas Company (SCE&G). The total design capacity of all steam generating facilities is almost 15 million pounds/yr.

- Domestic Water

The Domestic Water System produces and distributes all domestic water to the SRS population in compliance with state and federal regulations. Water quality is governed by the Secondary Water Quality Standards. Included in domestic water systems is the production and distribution of bottled water.

Domestic water is drawn from 20-inch diameter production wells using vertical turbine pumps that are installed in the aquifer approximately 700 feet below grade. Most of the domestic water produced is used directly by the SRS workforce population; however, some domestic water is used for equipment cooling, fire

protection water, and as make up water to cooling towers.

Before 1997, each SRS area had individual domestic water systems, totaling 28 independent systems. To implement the new regulatory requirements of the Safe Drinking Water Act, many of the individual systems were consolidated. Now the site has 18 domestic water systems, including three large systems that supply 98% of the site's domestic water requirements. The three large systems have water treatment facilities located in A, B, and K Areas. The B-Area treatment facility is a stand-by for the A-Area facility. Well water is treated in the large treatment facilities with either soda ash or caustic to adjust the pH, phosphate to reduce corrosion, and sodium hypochlorite as a disinfectant.

The domestic water distribution systems have approximately 32 miles of intra-area distribution piping and 26 miles of inter-area distribution piping with five elevated storage tanks.

- Firewater System

The Firewater System provides reliable firewater supply and distribution systems within all the operating areas in support of safety, facility operations and loss prevention at the SRS in compliance with appropriate codes and standards. Within the SRS Firewater System are 16 water supply and distribution systems, which in turn supply 245 water-based fire suppression systems as well as approximately 1,500 fire hydrants, valves and curb boxes used by the SRS Fire Department for manual fire fighting.

Sixteen fire protection water supply and underground distribution systems support the operating areas of SRS. A reliable fire protection water supply is crucial to ensure life safety. In addition, these systems ensure against vital program interruption, safety class equipment (and containment provisions) damage, property

and monetary losses and release of radiological or other hazardous material from fire.

A few of the fire protection water supply and distribution systems have been in service since the early 1950s. The other systems have been installed and/or modified within the last 10 years. Piping materials range from unlined cast iron in the 1950s, to concrete-lined cast and ductile iron, to PVC pipe in current installations. Pumping systems have improved from manually operated steam turbines to electric and diesel driven fire pumps in dedicated pump house facilities.

- Process/River Water System

The mission of the Process/River Water System is to produce and provide process water to facilities throughout the SRS in support of facility operations and site missions. This support is required to be reliable, in compliance with applicable regulations, and cost effective. The current average demand for process water is 2,400 gallons per minute (gpm) with an additional 285,000 gallons of deionized water produced each month in direct support of SRS missions. The river water system now supplies 5,000 gpm of river water primarily to L Lake and also to K Area, L Area and Par Pond as required.

The SRS Process Water Systems have been in operation across the site for over 45 years. Components of these systems include process water wells, process water distribution systems, deionized water systems, chemical treatment facilities and the river water system. With minor exceptions, the basic configuration of the process water systems has remained unchanged since their original installation. Process water is used to provide water for once-through cooling, as a supply of make-up water for cooling tower water systems, as a feed to deionizers, which supply deionized water (water treated to remove both anions and cations) to boilers and other

applications as a water supply for fire water storage tanks and for flushing and wash-down.

The river water system was installed in the early 1950s to provide cooling water to the five SRS production reactors. The system consisted of, basically, a distribution system of 50 miles of large, 46-inch to 84-inch diameter pipe and three pump stations each with ten 25,000 gpm pumps. With reactor cooling water no longer required, two pump stations have been retired with the third now providing water to, mostly, maintain the level of L Lake and, in times of drought, Par Pond. Reduced requirements and funding limits have caused system maintenance to be sharply reduced. The system itself, however, remains functional as determined by a comprehensive review performed in 1996.

- Sanitary Wastewater System

The Sanitary Wastewater Systems provide for the collection, treatment, and discharge of sanitary wastewater effluent within South Carolina Department of Health and Environmental Control (SCDHEC) and National Pollutant Discharge Elimination System (NPDES) outfall limits for the SRS population. These systems include a central treatment facility capable of handling over 1 million gallons of sanitary wastewater each day, five smaller treatment plants, 58 miles of sewer pipe and 44 lift stations.

Ninety six percent (96%) of the SRS sanitary wastewater is treated at the Central Sanitary Wastewater Treatment Facility (CSWTF). The CSWTF is located on Burma Road and was installed in 1994-95. The original design capacity of approximately 1,050,000 gallons per day (gpd) was for a much larger site population of approximately 30,000 employees. The current CSWTF average flow rate is approximately 18% of design capacity. This flow rate reduced organic loading has presented a few operational issues. The facility receives sanitary wastewater

transported through an inter-area collection system.

The inter-area collection system was also installed in 1994-95 and consists of 18 miles of mostly pressure sewer line and 12 additional lift stations necessary to transport the sanitary wastewater to the CSWTF. This system collects the sanitary wastewater from the A, B, C, E, F, H, M, N and S Areas of SRS. The remaining 4% of the SRS sanitary wastewater is generated and treated at smaller, independent, treatment facilities located in the remote areas of D, TNX, L, K and P Areas.

Many of the intra-area sanitary wastewater collection systems were installed when SRS was constructed in the early 1950s and includes about 40 miles of mostly gravity sewer pipe.

- Electrical Distribution System

The Electrical Distribution System in each area provides a reliable source of electrical power to all SRS processes and facilities in compliance with appropriate regulations and standards. The major equipment associated with the electrical distribution systems includes switchgear, transformers, reclosers, overhead lines and underground cables. There are approximately 114 miles of overhead line (including 3000 poles, 299 pole mounted transformers and associated hardware), 18 miles of underground cable, four automatic reclosers, and 369 pad transformers (includes switchgear and associated hardware).

SRS electrical power is supplied, under contract, from the South Carolina Electric & Gas (SCE&G) 115 kilovolts (kV) Transmission System. The contract specifies demand levels, energy rates and operating protocol for electrical power supplied to SRS. The 115 kV power supply is transformed to a medium voltage level, typically 13.8 kV and then distributed to the site distribution systems by WSRC. The transmission and distribution systems at SRS

provide a reliable source of power to all processes and facilities on the site. Electrical power for SRS is provided from three high voltage lines:

- South Carolina Electric & Gas - 1 with a capacity of 160 megawatts
- South Carolina Electric & Gas - 2 with a capacity of 160 megawatts
- South Carolina Electric & Gas - 3 with a capacity of 336 megawatts

The electrical power is transmitted throughout the site at 115,000 volts (115 kV). The 115 kV transmission system consists of wooden poles, phase conductors, static wires, insulators, pole line hardware, switching stations, and substations. The 115 kV transmission system substations and lines are arranged in interconnecting loops, which provides SRS process areas and facilities with redundant sources of power.

- Emergency Services

The site has a comprehensive emergency management program that covers all phases of emergency planning, mitigation, preparedness, response, and recovery. The level of support to any area, facility, or division is driven by the hazards involved and by the impact to the worker, the general site population, the offsite population, and the environment.

SRS maintains a fully manned, equipped, trained and qualified fire department capable of responding to fires, medical emergencies, hazardous material emergencies, and rescue situations. Three stations are located on site. Fire Protection Systems are established, implemented and maintained throughout the site facilities in support of life safety, loss prevention and continued facility operations. In order to effectively support existing and future site missions, these systems must be maintained in an operable, reliable and code compliant condition.

SRS also has a round-the-clock Emergency Operations Center (EOC) and Savannah River Site Operations Center (SRSOC). The EOC is a dedicated emergency response facility. The SRSOC is a continuously staffed 911 facility, which also houses the Fire Alarm Computer System.

- Endangered Species

The site is currently restoring native vegetative communities and species, including red-cockaded woodpecker habitat, hardwood habitat, pine-savannahs, and wetlands. In addition, this restoration will protect water quality by stabilizing soil and minimizing industrial area runoff through engineering and vegetative management techniques. Carolina bays and the site's dominant natural vegetation, longleaf pine savannahs, are being restored and restoration is proceeding where it's compatible with ambient soil conditions. Prescribed burning operations continue to enhance wildlife habitat, facilitate post timber harvest regeneration, and reduce forest fuels. Soil and watershed maintenance and stabilization provide infrastructure support to the SRS industrial areas. Natural resource research projects cover a wide range of topical areas, including short rotation woody crops; biodiversity; prescribed fire and smoke management; wetland, pine savannah, and hardwood restoration; and endangered species recovery.

In June 1999, DOE designated 10,000 acres of the Savannah River Site as a biological and wildlife refuge, creating the Crackerneck Wildlife Management Area and Ecological Preserve. The South Carolina Department of Natural Resources manages the reserve (under a long-term lease) and associated deer hunts and maintains the site's wild turkey populations.

SRS provides habitat for four federal endangered species, the red-cockaded woodpecker, wood stork, shortnose sturgeon, and smooth purple coneflower, and two federal

threatened species, the bald eagle and American alligator. Planning for habitats for these species is important because available current and future land use in the immediate vicinity of federally threatened or endangered species is limited.

Other site species require consideration because the protection and management philosophy for the DOE Research Set-Aside Areas states that they are for research; should receive as little management as possible; should be protected to remain as natural as possible with little or no human influence; and are primarily for non-manipulative research. These areas also function as "control areas" in evaluating the effects of SRS operations and forest management activities. The largest of these areas is the E. P. Odom Wetland Set-Aside, which includes the northern section of the Upper Three Runs Creek watershed and is specifically protected by the SRS Stream Management Policy.

The Research Set-Aside Areas total 14,005 acres, about seven percent of the site. These areas are excluded from most routine maintenance and forest management activities. The Research Set-Aside Areas were selected to represent most of the site's major habitat types and include old fields, sand hills, upland hardwoods, mixed pine/hardwoods, bottomland forests, swamp forests, Carolina bays, and fresh water streams and impoundments.

3.1.5 Surface Contamination

SRS has identified 515 inactive waste units and 1013 facilities for deactivation and decommissioning. In addition, many of the streams and creeks have some contamination due to run off from production facilities or the use of surface water for cooling water. Additional details can be found in Chapter 4, *Hazard Specific Discussion*.

3.1.6 Future Infrastructure Needs and Plans

While it is anticipated that some of the infrastructure will not be needed in the future, some level of infrastructure will be needed after the site reaches the end state described in this document. For example, railroads will be phased out as end states are reached, but some roads will be necessary for remaining site employees for continuing National Nuclear Security Administration (NNSA) missions, for potential new missions and for monitoring and long-term stewardship. For NNSA missions and potential new missions for SRS, water, electricity, and other utilities will still be needed in certain areas. In addition, the dams will need to be maintained indefinitely to contain radioactive sediments and to support biological, environmental and ecological research. The need for emergency services, including the site's fire department and the Emergency Operations Center will remain; however, these may be at a reduced level by 2025.

3.2 Human and Ecological Land Use

3.2.1 Land Uses

Except for site facilities, SRS land cover is a wide variety of natural vegetation types with more than 90 percent in forest land. Open fields and pine and hardwood forests comprise 73 percent of the site; approximately 22 percent is wetlands, streams, and two lakes; and production and support areas, roads, and utility corridors account for the five percent of the total land area. SRS includes several production, production support, service, research and development, and waste management area. (See Map 3.2., *Site Human and Ecological Land Use – Current State* in Appendix A, *Regional and Site Maps*.)

3.2.2 Differences Between Current State, Performance Management Plan (PMP) End State Plan, and Vision End State

SRS land has been and will continue to remain under federal ownership. Land cover will remain as a wide variety of natural vegetation types with more than 90 percent in forest land. In addition, the 22 percent of the site that is wetlands, streams and two lakes will continue through the *End State Vision* end date. The PMP planned that 72 facilities would have been deactivated and decommissioned by 2006, and 515 inactive waste units remediated by 2026. The *End State Vision* plans for 1,013 facilities to be deactivated and/or decommissioned unless reused to support other long-range federal missions at SRS or designated for historical preservation or economic development, and all 515 inactive waste units remediated. Many of these facilities and inactive waste units will remain in situ, leaving the percentages for natural vegetation; wetlands, streams and lakes; and production and support facilities to be similar to current state. For example, reactor buildings, canyon facilities, and high-level waste tanks will deactivated and decommissioned in situ. Since these types of facilities are the largest facilities on the site, the percentage for production and support facilities will remain the same.

Protection of federally endangered species and wildlife habitats will continue beyond 2025. Ecological research will also continue.

3.3 SRS Legal Ownership

3.3.1 Site Ownership – Current and 2025 End State

The site is owned by DOE and operated by an integrated team led by WSRC. (See Map 3.3., *Site Legal Ownership – Current State* in Appendix A, *Regional and Site Maps*.) The *End State Vision* plans for continued federal

ownership of the land, most likely the Department of Energy. Currently, there are NNSA missions that may extend beyond the 2025 window. This follows the recommendation of the Citizens Advisory Board Recommendation Number 8 made in 1995 and previous land use plans. The land was formerly owned by individual farmers and landowners, and there has not been any industrial/manufacturing interest in private ownership of the land because the site is located in a remote, rural area.

In addition, federal law requires that any excess land and/or facilities must be turned over the Bureau of Land Management. This Bureau looks for other federal agencies that might have a use for the land, and then any state agency or municipality before it could be considered for sale to the public. However, to do so, the land and facilities would need to be remediated to residential standards.

3.3.2 Surrounding Site Ownership

As discussed in Chapter 2, the land use surrounding SRS primarily includes residential, light industry, heavy industry, and recreation. Land surrounding the site is owned by both private individuals and companies. In 2025, it is expected that the land use and ownership will be similar to current land use and ownership.

3.4 SRS Demographics

Major SRS employers include the following: (The number of employees shown is as of May 31, 2005.) (See Map 3.4.a., *Site Demographics – Current State* in Appendix A, *Regional and Site Maps*.)

Department of Energy –Savannah River (DOE-SR), which provides management and oversight for non-National Nuclear Security Administration activities. There are approximately 355 DOE-SR employees at SRS.

Department of Energy – National Nuclear Security Administration, which provides management and oversight for NNSA activities. There are approximately 32 DOE-NNSA employees at SRS.

Westinghouse Savannah River Company, with Bechtel Savannah River Company, British Nuclear Group (BNG) America Savannah River Corporation, BWXT, CH2M Hill, and Polestar, which manages and operates SRS for DOE and NNSA. WSRC and its partners have approximately 10,174 employees at SRS.

Wackenhut Services, Inc. (WSI), which provides and manages the site security force. WSI employs approximately 865 employees at SRS.

Savannah River Ecology Laboratory (SREL) which provides site ecological evaluations and research. The University of Georgia, which manages SREL, employs approximately 189 employees.

USDA United States Forest Service - Savannah River (USFS-SR), an independent unit of the United State Forest Service, which manages the site's natural resources. There are approximately 92 SRFS employees at SRS.

Other employers include the University of South Carolina Institute of Archaeology and Anthropology, the U. S. Department of Agriculture's Soil Conservation Service, and the South Carolina Fish and Wildlife Service.

The number of employees will change considerably over the next 20 years as end states are reached. WSRC may or may not be the management and operating contractor, in fact, a new contract format may be in operation at the time. The WSI contract will also be available for renewal or rebid during the timeframe of this Vision. While the need for security for DOE-SR missions will decrease over time as end states are reached, there will be a need for additional security for the Mixed Oxide (MOX) facilities

for the disposition of excess DOE Complex plutonium and if new missions are assigned to SRS. It is anticipated that SRFS will maintain its presence at SRS and will continue the same mission that it current has.

3.4.1 Surrounding Site Demographics Differences Between Current and 2025 End State

A careful examination of economic development plans for the region indicates normal growth expected in metropolitan counties in the region. There are no major changes to the demographics surrounding the site anticipated by 2025.

3.5 Selection of Sites for Future Missions

As part of the evaluation process for new missions and facilities, potential sites must be identified and characterized to determine their

suitability. This screening process allows site management to determine if SRS has suitable sites for new projects, based on anticipated requirements and criteria, such as available space, infrastructure, support services, geological conditions, etc. Also this information provides preliminary guidance to site managers and planners for input into the National Environmental Policy Act (NEPA) process. (See Map 3.4, *Current Locations without Restrictions* and Map 3.5, *Future Development – Suitable for Industrial Missions* in Appendix A, *Regional and Site Maps*.)

4.0 HAZARD SPECIFIC DISCUSSION

4.1 Chapter Purpose

In this chapter, the hazards that are managed at the Savannah River Site (SRS) are discussed in terms of their current states—their origin, nature, form, and amount—and the end states that will be achieved for each hazard by the end of the currently planned Environmental Management (EM) Cleanup Program.

First, each hazard category is discussed. This discussion explains the current hazard, whether it is a contained hazard or released hazard, the risks, the planned end state, the controls that are in place for that hazard, and references for those controls. The general framework for deciding the end states of radiological and nuclear facilities (that is, the factors to be considered) is also presented. Next each watershed is discussed with hazard-specific information provided. In the last major section, each SRS industrial area is described in terms of the hazards present there now and the hazards that will remain in each area at the end of planned EM cleanup.

SRS hazards are organized into five major classes. The five classes are further subdivided into fourteen categories:

- **Nuclear Materials:**
 - plutonium,
 - uranium,
 - spent nuclear fuel, and
 - tritium
- **Radiological Waste:**
 - liquid radioactive waste (LRW),
 - transuranic (TRU) waste,
 - low level waste (LLW) and
 - low-level mixed waste (LLMW)
- **Non-Radiological Waste:**
 - hazardous and
 - sanitary waste
- **Inactive Waste Units:**
 - contaminated soil and
 - groundwater

- **EM Facilities:**

- nuclear, radiological, other industrial facilities and
- liquid radioactive waste tanks

The objective of Chapter 4 is to provide the greatest level of detail at the most appropriate scale of SRS hazards and their respective end state. SRS has elected to present all individual hazards through Conceptual Site Models (CSMs) at the appropriate watershed or area scale. The watershed scale is used to depict groundwater plumes and facilities in the general site area (G Area). This scale is appropriate for these two hazards due to the extensive area that groundwater plumes encompass and the fact that G-Area facilities represent the remaining area within a watershed outside of site process or industrial areas. The area scale is appropriate to focus on hazards associated with an industrial area and its processes and activities. This includes hazards both inside and near area perimeters. Areas (or appropriate portions of areas) are then presented in their respective IOUs.

IOUs are contained within their respective watersheds identified by the same name (see Appendix I, *Conceptual Site Models and Hazard Tables*, Figures 4.1b to 4.6b Watershed/IOU CSMs). Figure 4.0, *SRS Sitewide Conceptual Site Model*, in Appendix I, provides a high-level (greatest scale) SRS sitewide CSM that shows the relationship between the individual watersheds/IOUs, industrial/process areas, and the eventual receptor of the Savannah River and Savannah River Floodplain

On the next page, Table 4.1, *SRS Hazards, Current Status and End State*, depicts a site summary of SRS hazards, current form, planned end state, and areas where the hazard is located. Also in this chapter, Figures 4.1 to 4.5 pictorially show the disposition path for the

hazards. Appendix I, *Watershed Conceptual Site Models and Hazard Tables*, provides the conceptual site models for each watershed with

hazard tables. Appendix J, *Area Conceptual Site Models and Hazard Tables*, provides conceptual site models for each SRS area and hazard tables.

.

Table 4.1 SRS Hazards, Current Status and End State

<i>Hazard Class/Category</i>	<i>Current Status</i>	<i>Planned End State</i>	<i>Current Form</i>	<i>Current Amount</i>	<i>Current Area(s)</i>
Nuclear Materials Class					
Plutonium (Pu)	Plutonium nuclear materials are being stabilized, interim stored if necessary, and dispositioned.	Plutonium will be removed from SRS via Mixed Oxide (MOX) fuel fabrication, processed through the canyon and associated B-Line facility, processed through other future options, or to a federal repository.	See Figure 4.1, <i>EM-owned Nuclear Materials</i>	See Figure 4.1, <i>EM-owned Nuclear Materials</i>	F, H and K Areas
Uranium (U), Highly Enriched Uranium (HEU) and Depleted Uranium (DU)	Uranium nuclear materials are being stabilized, interim stored if necessary, and dispositioned offsite.	Uranium will be dispositioned offsite via commercial vendors, processed through a canyon, or dispositioned to a federal repository or a commercial disposal site as appropriate.	See Figure 4.1, <i>EM-owned Nuclear Materials</i>	See Figure 4.1, <i>EM-owned Nuclear Materials</i>	F, H, K, R, and N Areas
Spent Nuclear Fuel (SNF)	All SNF at SRS is consolidated in single storage.	All SNF will be shipped offsite for final disposal at the Yucca Mountain federal repository.	Individual fuel elements	See Figure 4.1, <i>EM-owned Nuclear Materials</i>	L Area
Tritium	Ongoing mission to extract new tritium and recycle stockpile tritium.	Ongoing mission to extract new tritium and recycle stockpile tritium.	See Figure 4.5, <i>Tritium Reprocessing/Processing</i>	See Figure 4.5, <i>Tritium Reprocessing/Processing</i>	H-Area

Table 4.1 SRS Hazards, Current Status and End State

<i>Hazard Class/Category</i>	<i>Current Status</i>	<i>Planned End State</i>	<i>Current Form</i>	<i>Current Amount</i>	<i>Current Area(s)</i>
Radiological Waste Class					
Liquid radioactive waste (LRW)	Approximately 37 million gallons (~426 million curies) stored in 49 underground storage tanks. Sludge being removed, treated and fed to the Defense Waste Processing Facility (DWPF) for vitrification; 1900 of 5060 canisters made and stored in the Glass Waste Storage Building. Tailored salt disposition approach to begin October 2005.	All removed LRW will be shipped offsite for final disposal at the Yucca Mountain federal repository.	Sludge, Hard Salt Cake and Liquid Supernate	Sludge – 3 million (M) gallons or 203M curies Hard Salt Cake – 17M gallons or 12M curies Liquid Supernate – 17M gallons or 211M curies	F, H, S, and Z Areas
Transuranic (TRU) Waste	TRU waste is in interim storage and is being shipped off site to the Waste Isolation Pilot Plant (WIPP) for permanent disposal. Over 10,000 drums have been shipped to date.	All SRS TRU waste (and any mixed TRU) will be shipped offsite to the WIPP federal repository for permanent disposal.	See Figure 4.4, <i>Waste Management</i>	See Figure 4.4, <i>Waste Management</i>	E Area
Low Level Waste (LLW)	All new LLW is disposed in Solid Waste Management Facilities (SWMF).) or sent to a federal or commercial offsite disposal facility.	Low level waste will be disposed on site in accordance with the Atomic Energy Act and Department of Energy (DOE) Order 435.1, <i>Radioactive Waste Management</i> , or sent offsite to a federal or commercial offsite disposal facility	See Figure 4.4, <i>Waste Management</i>	See Figure 4.4, <i>Waste Management</i>	E Area
Mixed Waste (MW) (Low Level Mixed Waste) (LLMW)	Legacy MW is interim-stored onsite until treated in accordance with the Site Treatment Plan schedules. Newly generated MW is typically treated within <12 months per RCRA. All MW is permanently disposed offsite at a commercial disposal facility.	All MW will be permanently disposed off site via commercial vendors or permitted federal facility.	See Figure 4.4, <i>Waste Management</i>	See Figure 4.4, <i>Waste Management</i>	H, N & E-Area

Table 4.1 SRS Hazards, Current Status and End State

<i>Hazard Class/Category</i>	<i>Current Status</i>	<i>Planned End State</i>	<i>Current Form</i>	<i>Current Amount</i>	<i>Current Area(s)</i>
Non-Radiological Waste-Class					
Hazardous Waste (HW)	Legacy (pre-LDR) HW is interim stored onsite awaiting treatment/disposal by end of FY06. All newly generated HW is interim stored onsite typically for <12 months per RCRA prior to offsite commercial treatment/disposal.	All HW will be permanently disposed offsite via commercial vendors.	See Figure 4.4, <i>Waste Management</i>	See Figure 4.4, <i>Waste Management</i>	N-Area
Sanitary	Sanitary Waste is permanently disposed onsite and offsite.	Sanitary waste is permanently disposed onsite and offsite.	Similar to all municipal-type waste and construction and demolition waste from decontamination and decommissioning activities.	SRS generates about 1000 tons per month of municipal-type waste and 3000 tons of Construction and Demolition waste	All areas
Inactive Waste Units Class					
Soil	There are 497 surface units. 312 are remediation complete, 137 are in assessment and 48 are in remediation. A portion of the surface units also have a groundwater component. A portion of the surface units also have a groundwater component.	Cleaned up (remediated) to $10E^{-4}$ to $10E^{-6}$ residual risk per industrial or maintenance exposure scenario consistent with future land use. All waste units will be deleted from the National Priorities List (NPL) either individually or by area with institutional controls in place as needed.	Soil	497 surface units - lifecycle	All areas (except Z)
Groundwater	There are 18 groundwater units. 5 are remediation complete, 6 are in assessment and 7 are in remediation.	Groundwater cleanup to Environmental Protection Agency (EPA) Maximum Contaminant Levels (MCLs) will be achieved through treatment,	Groundwater	18 groundwater units --	A, C, D, E, F, G, H,

Table 4.1 SRS Hazards, Current Status and End State

<i>Hazard Class/Category</i>	<i>Current Status</i>	<i>Planned End State</i>	<i>Current Form</i>	<i>Current Amount</i>	<i>Current Area(s)</i>
		Monitored Natural Attenuation, long term monitoring or combination thereof as needed. All waste units will be deleted from the National Priorities List (NPL) with Institutional Controls in place as needed.		lifecycle	K, L, M, N, P, R, T
EM Facilities Class					
LRW Tanks	There are 51 LRW Tanks at SRS. Two of the 51 LRW Tanks have been operationally closed under SC Industrial Wastewater Closure Plan.	All 51 LRW Tanks will be operationally closed and grouted in place as the final in situ decommissioning	Tanks	51 tanks (2 closed)	F and H Areas
Nuclear, Radiological and Industrial Facilities	There are 1013 EM Facilities (including the 49 "to go" LRW Tanks) totaling 11.4 million square feet. Most are still in use supporting the EM Cleanup Project. Through CY04, 140 facilities had completed decommissioning and 2 LRW tanks have been closed.	All EM Facilities may be permanently decommissioned unless reused to support other long-range federal missions at SRS or designated for historical preservation or economic development. 858 facilities are planned to be demolished and 156 are planned for in situ disposal. The EM Deactivation and Decommissioning (D&D) cleanup goal and strategy are to complete D&D in a manner that will not create a new waste unit (that is, a release or potential release of hazardous substances to the environment.)	Buildings and facilities	1013 facilities lifecycle, including 49 LRW tanks	All Areas

Nuclear Materials Disposition Maps

Figures 4.1 through 4.3 describe the planned processes and ultimate disposition for the hazard class of Nuclear Materials at SRS. In many cases, portions of the materials shown in the Sources/Materials Columns are still undergoing characterization to determine if the material is, in fact, suitable for the disposition path shown. In addition, many of the end state dispositions shown in the figures are currently a best projected pathway and will require preparation of, or modifications to existing, National Environmental Policy Act (NEPA) documentation, facility operating licenses, facility authorization bases, etc., in order for the pathways to be realized. For these reasons, figures are subject to change as analyses are

performed, options are further evaluated, legal documentation is modified, stakeholder input is obtained, and Department of Energy (DOE) programs are authorized and funded.

Figure 4.4 shows the movement (treatment and disposal) of the various types of wastes at SRS.

The origin of tritium entering the site for recycling or processing; the process or treatment that will be used to prepare it for use or disposition; and its ultimate use or disposition are shown in Figure 4.5, *Tritium Reprocessing and New Processing Material Disposition Map*. Because quantities of tritium are classified information, they are not shown on this diagram.

.

EM-Owned Nuclear Materials at SRS

Materials Planned to be Disposition as Waste

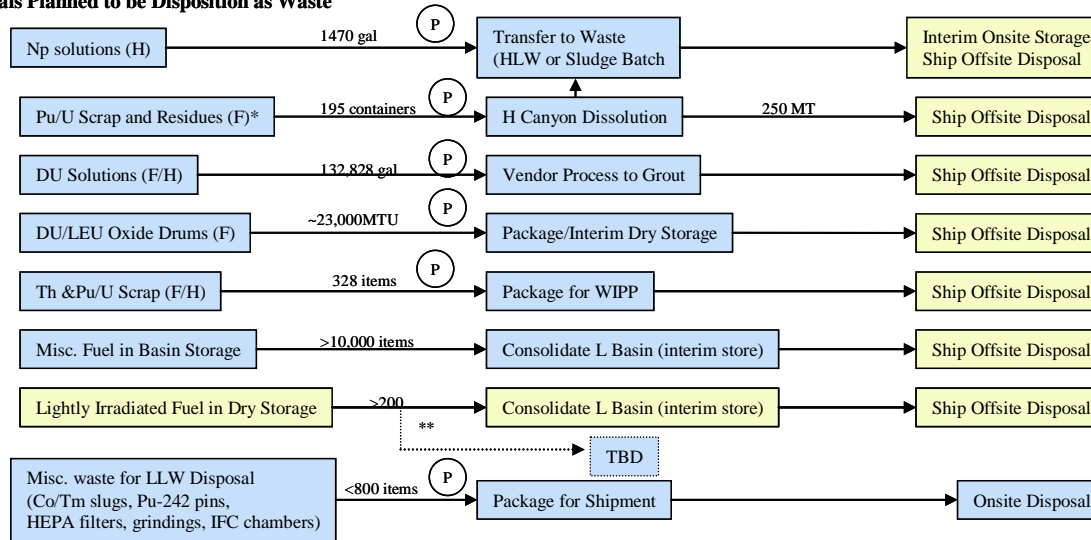

Materials Proposed for Offsite

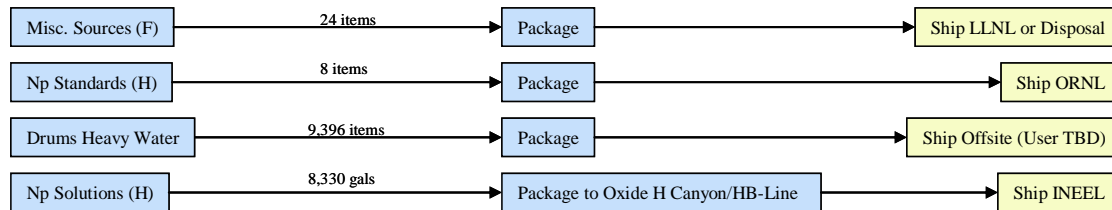

P In Process

**TBD per Contract Modification 100, option open for processing in H Canyon and blenddown to LEU for TVA use

*Materials currently in other locations

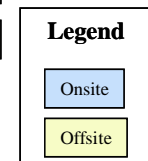
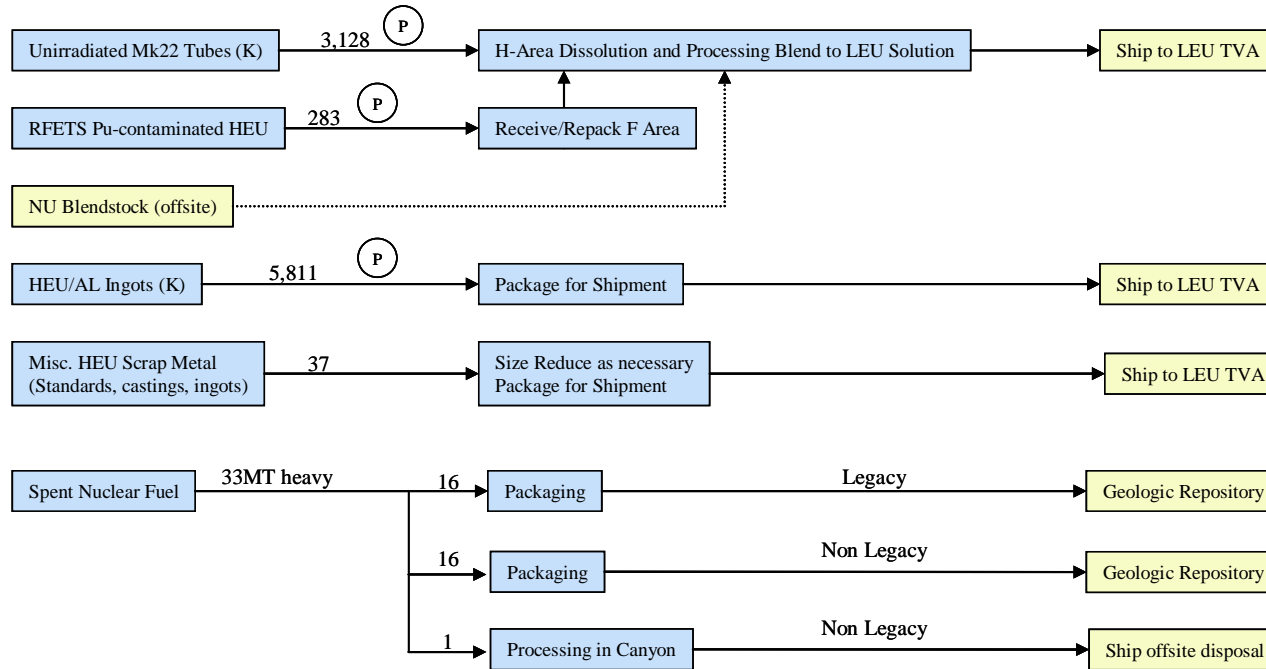

Figure 4.1 EM Owned Nuclear Materials at SRS

EM-Owned Nuclear Materials at SRS (continued)

Materials Included in the HEU Blenddown



Continued Use

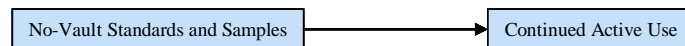

(P) In Process

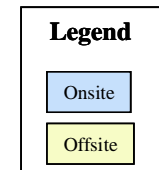
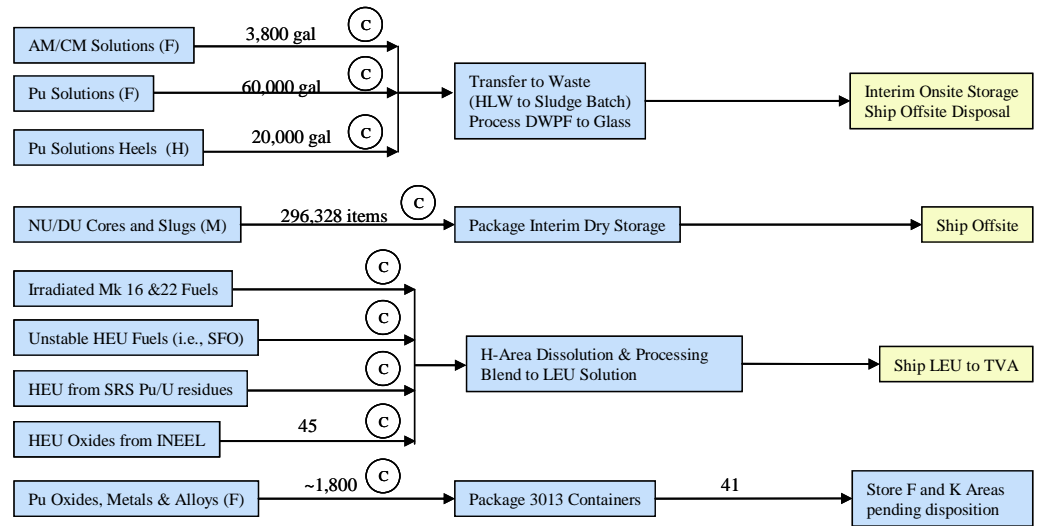

Figure 4.2 EM Owned Nuclear Materials (continued)

EM-Owned Nuclear Materials at SRS (continued)

Materials with Disposition Already Completed



Received from RFETS in FY 2003

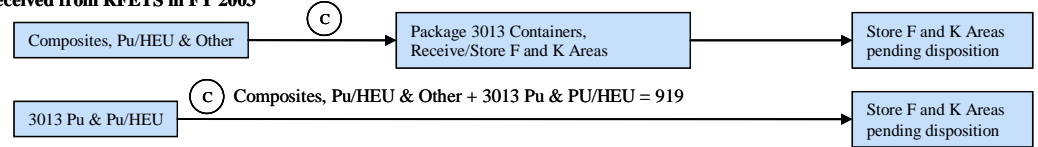

(C) Completed

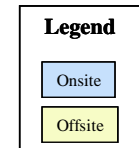

Figure 4.3 EM Owned Nuclear Materials at SRS (continued)

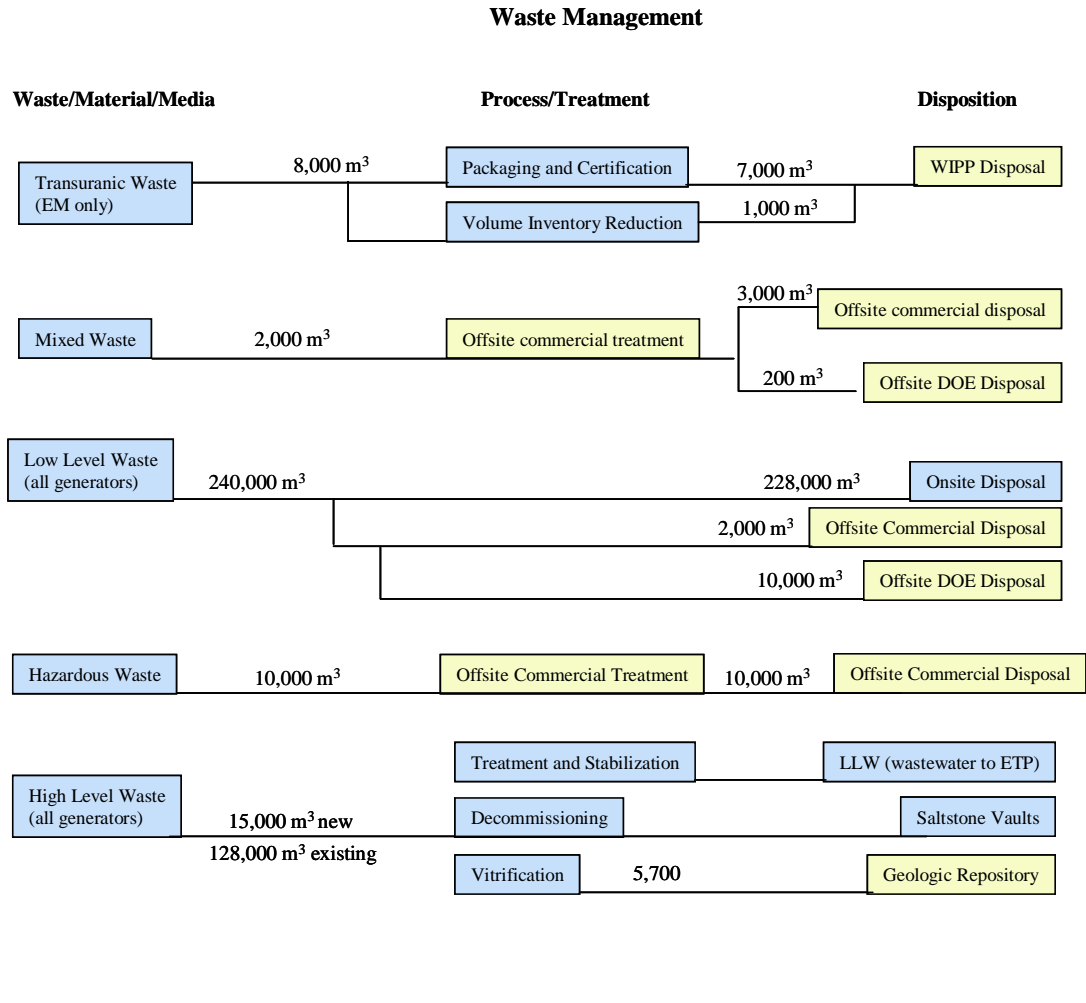

Figure 4.4 Material movements currently in the Waste Management Program

Tritium Reprocessing/Processing

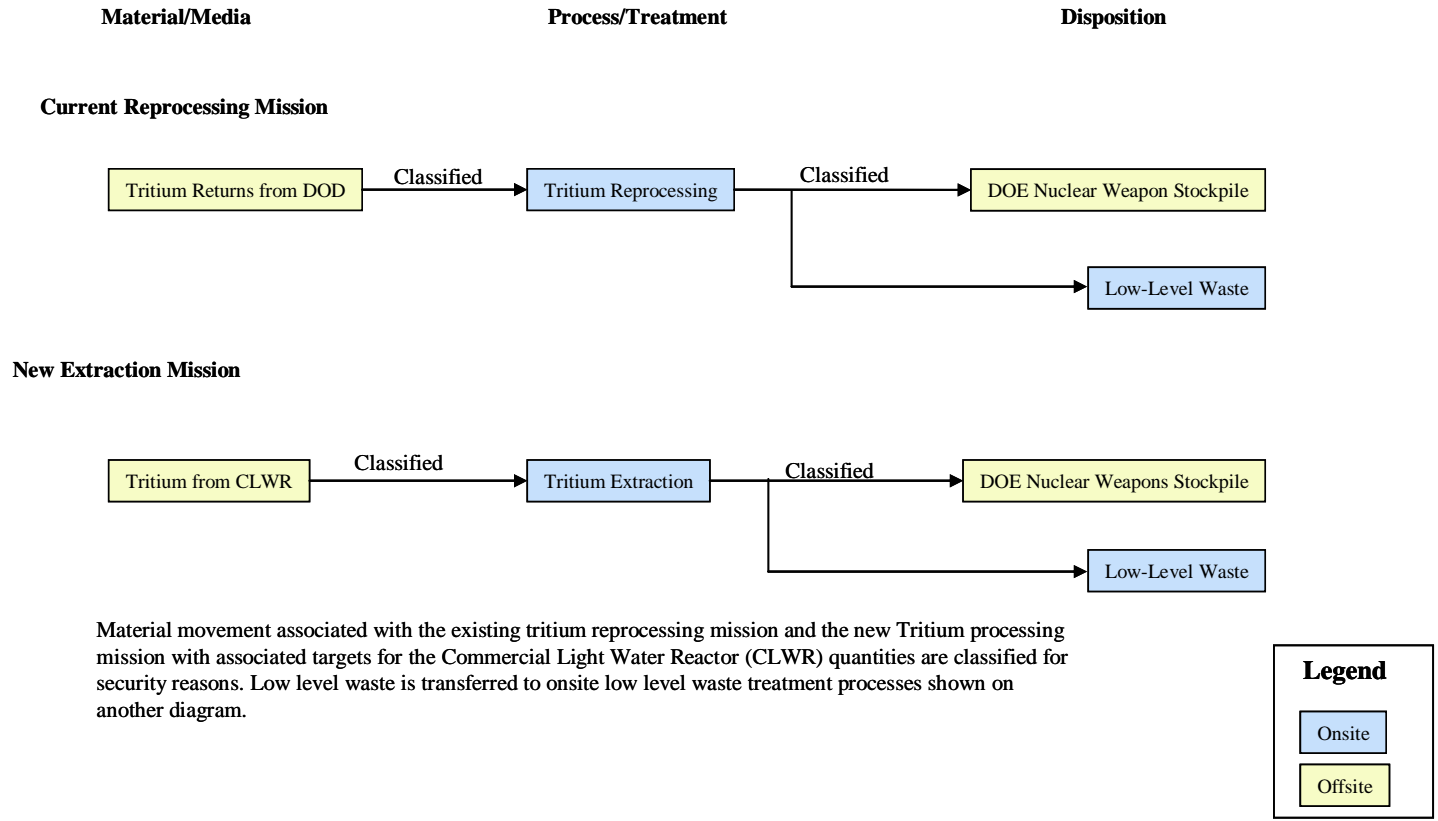

Figure 4.5 Tritium Reprocessing and New Processing Material Disposition Map

4.2 Site Hazards, Risk and Controls for Contained and Released Hazards

Contained Hazards:

Plutonium
 Uranium
 Spent Nuclear Fuel
 Tritium
 Liquid radioactive waste (LRW)
 Transuranic (TRU) waste
 Low Level Waste (LLW)
 Mixed Waste (MW)
 Hazardous Waste
 Sanitary Waste
 Environmental Management Facilities

Released Hazards:

Soil
 Groundwater

The hazard CSMs are designed to communicate the hazard's primary source, release mechanism (potential for contained hazards or actual for released hazards), pathways, exposure route and receptors. For the hazard primary source, the form, amount and facility areas will be noted for the current state and planned end state. For contained hazards, the risk and controls (barriers that contain and avoid a release) are described.

There are numerous and various types of hazards at SRS (reference Table 4.1.) The paragraphs below describe the hazard and discuss the current state, planned end state and final disposition, the risks and controls.

For each hazard, the major facilities associated with managing the hazard are defined and the associated documents (Documented Safety Analysis [DSA], Safety Analysis Report [SAR], Technical Safety Requirement [TSR], Radioactive Waste Management Basis, etc) that answer the question: How does DOE manage and control the hazard to ensure the contained hazard is not released to effect the worker, public or environment?

4.2.1. Hazard: Plutonium (Pu)

Hazard Description and Current Status:

Plutonium nuclear material is a contained hazard at SRS.

Plutonium is primarily a man-made element, produced by irradiating uranium in nuclear reactors. It exists in various forms and grades and is used in nuclear warheads and as fuel in nuclear reactors. The plutonium produced by DOE is held in several forms, including metals, oxides, solutions, residues and scraps. Most DOE plutonium is stored as a metal. Some plutonium forms require treatment and packaging for interim storage until a final disposition path is determined. Plutonium production has ceased in DOE. The excess or surplus plutonium is the hazard that requires storage, treatment and disposition. Because plutonium is highly radioactive, it poses acute dangers to human health and the environment, as well as to national security, unless it is properly stored and safeguarded.

Approximately 34 metric tons of surplus weapon-grade plutonium is planned for disposition by fabricating it into mixed oxide (MOX) fuel for irradiation in existing commercial nuclear reactors. This will convert the surplus plutonium to a form that cannot be readily used to make a nuclear weapon. In addition to the surplus weapon-grade plutonium, approximately 13 metric tons of legacy plutonium do not have a final disposition path and require storage, treatment and disposition.

Plutonium nuclear materials are being stabilized and interim stored, if necessary, and then dispositioned. Plutonium will be removed from SRS via the MOX fuel fabrication process, processed through the HB-Line facility or transferred to a federal repository. For example, most of the plutonium metals or oxides were packaged in certified DOE 3013 containers or

equivalent. The work was completed in FB-Line's Packaging and Stabilization process.

Through Fiscal Year (FY) 2004, a total of 919 containers of plutonium were packaged. The plutonium repackaging program is complete. For information on other plutonium nuclear materials, see Figure 4.1, *EM-owned Nuclear Materials*.

Planned End State (PES)

Plutonium will be removed from SRS via MOX fuel fabrication, processed through the HB-Line facility or transferred to a federal repository. Other processes that could result in a plutonium waste form suitable for disposal at a federal repository are pre-decisional. There will be no excess plutonium nuclear material at SRS at the PES.

Currently, plutonium is repackaged in 3013 containers for interim storage at the K-Area Material Storage Facility Project (KAMS) pending final offsite disposition. During the storage period, periodic surveillance is performed on a cross-section of stored packages. This surveillance will be performed in 235-F until a facility can be installed in 105-K. Plutonium is also dissolved in HB Line and dispositioned as waste via the tank farm.

HB Line, 235-F and KAMS are the primary facilities that ensure safe management of the plutonium hazard until it attains its final end state.

Risk

Because the plutonium was in forms that were not designed for long-term storage, the primary risk was moisture reacting with plutonium causing compounds to form which could compromise the integrity of the storage containers, creating a pathway for contamination to be spread to the workers, public and environment. Near-term risk reduction was

driven by the stabilization and packaging of all plutonium to DOE Standard 3013-2004, *Stabilization, Packaging, and Storage of Plutonium-Bearing Materials*. This repackaging activity is complete and thus the primary risk is eliminated.

Controls

The Safety Analysis Report (SAR), Documented Safety Analysis (DSA) and Technical Safety Requirement (TSR) establish the controls (barriers to a release) to contain the hazard and manage the associated risks.

References

K-Area

- *Technical Safety Requirements Savannah River Site, K-Material Storage Facility*, WSRC-TS-96-20, Rev.18, November 21, 2004
- *K-Area Material Storage Facility Documented Safety Analysis*, WSRC-SA-2002-00005 1, Rev 1, June 2004

235-F

- *Safety Analysis – 200 Area Savannah River Site Building 235-F*, WSRC-RP-89-575, Rev.3, January 2003
- *Technical Safety Requirements, Savannah River Site, Building 235-F*, WSRC-TS-97-3, Rev. 7, November 4, 2004
- *Justification for Continued Operations, Savannah River Site, Upgraded Interim Control Posture for Building 235-F*, WSRC-RP-2004-00432, Rev. 0, June 2004
- *Limited Extent Surveillance Modification (Addendum to the 235-F Safety Analysis Report)*, WSRC-RP-89-575, Rev. 0, April 2004

HB-Line

- *HB-Line Safety Analysis Report (U)*, Safety Analysis Report; WSRC-SA-2001-00009, Rev. 4, October 2004

- *HB-Line Technical Safety Requirements (U), Technical Safety Requirements: WSRC-TS-97-7, Rev. 18, October 2004*
- *HB-Line Continued Operation with Alternate Hydrogen Control for Phase I Scrap Recovery Processing, Justification for Continued Operation, WSRC-RP-2002-00615, Rev.2, January 20, 2005*

F-Canyon

- *Safety Analysis Report F-Canyon, A-Line, and Outside Facilities, WSRC-SA-2001-00004, Rev. 3A, September 2004*
- *F-Canyon Technical Safety Requirement, WSRC-TS-97-00015, Rev.1A, September 2004*

FB-Line

- *FB-Line Safety Analysis Report, WSRC-SA-2002-00006, Rev. 2B, September 2004*
- *FB-Line Technical Safety Requirements, WSRC-TS-98-00002, Rev. 3B, September 2004*

4.2.2. Hazard: Uranium (Highly Enriched Uranium [HEU] and Depleted Uranium [DU])

Hazard Description and Current Status

Uranium nuclear material is a contained hazard at SRS.

Uranium nuclear materials are being stabilized, interim stored (if necessary), and dispositioned off site. The uranium will be dispositioned off site via commercial vendors, processed through a canyon or dispositioned to a federal repository or commercial disposal site, as appropriate. Enriched uranium will be packaged in certified storage containers, and the work will be accomplished in H Area. Through FY 2004, 793 containers are ready for disposition, out of a lifecycle amount of 2,809 containers.

Plutonium and uranium oxides are residue materials, which will be packaged for disposition

in HB Line. Through December 2004, 407 kilograms (kg) have been packaged.

Depleted uranium oxide is being shipped to a commercial disposal facility for permanent disposal. Depleted uranium nitrate solution is being treated by a vendor for disposal at a federal low-level waste disposal facility, and natural uranium is being packaged in a form suitable for disposition. The work is being performed in F and M Areas. Depleted and natural uranium metal previously stored in M Area was disposed at a commercial facility in FY 2003. Through December 2004, 6,139 metric tons (MT) have been packaged shipped for disposal out of a lifecycle amount of 23,182.

L Basin, K Area and H Canyon are the primary facilities that ensure safe management of the Highly Enriched Uranium (HEU) hazard until it attains its final end state. F Area is the primary area that ensures safe management of the depleted uranium (DU) hazard until it attains its final end state.

For information on other uranium nuclear materials, see Figure 4.1, *EM-owned Nuclear Materials*.

Planned End State (PES)

All uranium will be removed from SRS by means as described above. No residual materials inventories will remain.

Risk

The primary risk from HEU is from exposure (worker) to the liquid form of the material. The risk is being reduced through blending to low enriched uranium and shipment off site to be reused in the commercial power generating industry. Current planning (FY 2005) has all of this material dispositioned by FY 2008, thus eliminating the risk.

The primary risk from DU nitrate solutions is from exposure (worker) to the liquid form of the material and its hazardous constituents. As the material is shipped offsite for treatment, the risk is reduced. Current planning (FY 2005) is for all of this material to be treated and dispositioned in FY 2005, thus eliminating the risk.

The primary risk from DU oxide is associated with the form (very low risk) and quantity of the material. As the material is shipped offsite, the remaining risk is reduced.

Controls

The SAR, DSA and TSR establish the controls (barriers to a release) to contain the hazard and manage the associated risks.

References

HB-Line

- *HB-Line Safety Analysis Report (U)*, Safety Analysis Report; WSRC-SA-2001-00009, Rev. 4, October 2004
- *HB-Line Technical Safety Requirements (U)*, Technical Safety Requirements, WSRC-TS-97-7, Rev. 18, October 2004
- *HB-Line Continued Operation with Alternate Hydrogen Control for Phase I Scrap Recovery Processing*, Justification for Continued Operation, WSRC-RP-2002-00615, Rev.2, January 20, 2005

H-Canyon

- *H-Canyon Safety Analysis Report (U)*, WSRC-SA-2001-00008, Rev. 5, February 2004
- *H-Canyon and Outside Facilities Technical Safety Requirements (U)*, WSRC-TS-96-19, Rev. 9, February 2004
- *Use of Gadolinium as a Neutron Poison for Pu Solutions in H-Canyon (U)*, JCO, (Justification for Continued Operation) WSRC-RP-2002-00632, Rev. 0, December 2002

- *Processing Pu Contaminated Scrap in H-Canyon (U)*, JCO, WSRC-RP-2004-00283, Rev. 0, September 2004

F-Canyon

- *Safety Analysis Report F-Canyon, A-Line, and Outside Facilities*, WSRC-SA-2001-00004, Rev. 3A, September 2004
- *F-Canyon Technical Safety Requirement*, WSRC-TS-97-00015, Rev.1A, September 2004

FB-Line

- *FB-Line Safety Analysis Report, WSRC-SA-2002-00006, Rev. 2B, September 2004*
- *FB-Line Technical Safety Requirements*, WSRC-TS-98-00002, Rev. 3B, September 2004

4.2.3. Hazard: Spent Nuclear Fuel

Hazard Description and Current Status

Spent nuclear fuel (SNF) is a contained hazard at SRS.

Spent nuclear fuel is heavy mass metal which is being prepared for final disposition. The work is now being performed in L-Area Reactor Disassembly Basin. Through FY 2004, 2.822 metric tons of heavy metal (MTHM) have been prepared out of a lifecycle amount of 36 MTHM.

L Basin and H Canyon are the primary facilities that ensure safe management of the spent nuclear fuel hazard until it attains its final end state. SNF will remain in wet storage until a packaging capability prepares it for disposition at the Yucca Mountain Federal Repository. Shipments are anticipated to complete in 2020.

Planned End State (PES)

All SNF will be shipped offsite for final disposal at the Yucca Mountain Federal Repository. There are no residual hazards planned after the end state.

Risk

Spent nuclear fuel is radioactive and contains fission products from irradiation. The fuel is stored underwater to provide shielding for workers. The water within the basin is continuously filtered and controlled chemically to minimize any corrosion or degradation of the fuel.

Controls

Potential spent fuel receipts are analyzed for safety/criticality before shipment is authorized. Once received, fuel and basin operating conditions are monitored under specific controls.

References

- *L-Area Material Storage Facility Documented Safety Analysis*, WSRC-SA-2004-00002, Rev. 0, June 2004
- *Technical Safety Requirements Savannah River Site, L-Material Storage Facility*, S-TSR-L-00002, Rev. 0, October 2004
- *Nuclear Criticality Safety Evaluation: Double Contingency Analysis for the L Disassembly Basin*, N-NCS-L-00018, Rev. 0, December 2002.

4.2.4. Hazard: Tritium

Hazard Description and Current Status

Tritium is a contained hazard at SRS.

Tritium is a radioactive form of hydrogen. An atom of normal hydrogen has one negative particle, called an electron, and one positive particle, called a proton. An atom of tritium has two additional neutral particles, called neutrons. The neutrons make the tritium atom unstable and cause it to emit a very low-energy form of beta radiation.

Like normal hydrogen, tritium can bond with oxygen to form water. When this happens, the

resulting water (called tritium oxide or tritiated water) is also radioactive. Because tritium oxide is chemically identical to normal water, it cannot be filtered out of water.

Tritium is processed in H Area. Tritium gas is purified and contained in tanks or hydrided on solid storage beds. Specific quantities and locations of tritium are classified.

The tritium purification process is designed to maintain tritium in the elemental form. There are systems that collect tritium oxide and convert it to the elemental form. However, a certain amount of the tritium forms compounds other than water and may include tritium in organic molecules, such as oils or polymers, and tritium that forms hydrides of several metallic species as part of the tritium storage technology used in the facilities. The varying chemical properties of these compounds affect the biological behavior, and, therefore, the rate of exposure to persons who are exposed to these materials. A significant portion of these materials are in storage beds that will be sealed and transported to the site's solid waste facility as low level waste; however, it is expected that there will be a low level of residual material that must have the appropriate radiological controls to prevent personnel exposure.

Tritium also permeates the structural materials making up the primary containments and, in some cases, secondary containments in various facilities. This tritium may emanate ("outgas") from these materials over a period of years. The time required for outgassing to reach equilibrium with the environment varies based on the material. Concrete that has been exposed to high levels of tritium may contain significant levels of tritium after several decades. Metals such as stainless steel that have been used as process piping or primary containment may contain significant levels of tritium for even longer periods.

The Tritium Mission is an ongoing National Nuclear Security Administration (NNSA) mission to extract new tritium and recycle stockpile tritium. See Figure 4.5, *Tritium Reprocessing/Processing* for more information.

Reference the *NNSA-Savannah River Operations Office (SRSO) Ten-Year Comprehensive Site Plan FY 2005* for additional information.

Planned End State (PES)

Tritium will continue to be a contained and managed hazard at SRS. The projected need for tritium reservoirs for nuclear defense continues beyond the timeline in the *SRS End State Vision*.

Risk

Any possible adverse health effects from tritium are the result of the beta radiation it emits. Because tritium's radiation cannot penetrate the skin, the only real exposure a person receives is the radiation received while tritium is inside the body.

Exposure time – and thus the possibility of health effects – depends on the form of tritium present: elemental tritium gas, tritium oxide, or particulates. While people can inhale tritium gas, only about 0.004 percent is retained more than a minute or so, so it is an insignificant exposure hazard.

Tritium oxide can enter the body in various ways. It can be inhaled as water vapor, absorbed by the skin, or ingested. Regardless of the way it enters the body, tritium oxide immediately mixes with the body fluids and is eliminated like normal water. The rate of elimination naturally varies from person to person. In general, however, half of the tritiated water is eliminated in 10 days. This can be sped up by drinking larger quantities of liquids.

Tritium in the food chain follows the same pattern. Tritiated water goes through an animal's

body and is eliminated with the other fluids, rather than settling in the animal's body. Depending on the size of the animal, this time can be days, hours or minutes.

Tritium that has contaminated groundwater at SRS poses a risk if the groundwater is ingested or inhaled, as described above.

Controls

Tritium processing equipment uses technology advances to improve safety, health and environmental protection. These advances include secondary confinement of tritium processing systems in gloveboxes, and glovebox cleanup systems to minimize tritium releases to the environment. Metal hydride beds are used for tritium storage in a safe solid form. Dry pump systems eliminate the use of oils and mercury that may generate hazardous or mixed wastes.

Getter bed technologies replaced the previous oxidation-absorption technology of stripping small amounts of tritium from gas streams. Getters are designed to remove tritium and other elemental hydrogen isotopes from the gas stream onto a metallic material such as a metal hydride.

Process piping is the primary containment for tritium facilities.

The SAR, DSA and TSR establish the controls (barriers to a release) to contain the hazard and manage the associated risks.

SRS institutional land use controls prevent the use of groundwater as a source of water for drinking or showering. Thus, those exposure routes (ingestion, inhalation) for tritium-contaminated groundwater are prevented.

References

- *Tritium Safety Analysis Report*, WSRC-SA-1-2, October 2003

- *Tritium Facilities Technical Safety Requirements*, WSRC-TS-96-17, October 2003

4.2.5. Hazard: Liquid radioactive waste

Hazard Description and Current Status

Liquid radioactive waste (LRW) is a contained hazard at SRS.

This waste exists as sludge, salt cake and salt supernate stored in 51 underground tanks located in H and F area tank farms. One of these tanks has received only low-level waste to date and two tanks have been closed. Of the approximately 37 million gallons of LRW currently in storage, 3 million gallons is sludge, 17 million gallons is in the form of salt cake and 17 million gallons is in liquid supernate form. These volumes change slightly as new waste is generated and received and then evaporated to the extent possible to reduce its volume.

Currently the sludge is being removed from selected tanks, washed and fed to the Defense Waste Processing Facility (DWPF) for vitrification. DWPF has processed 1900 canisters of the estimated 5060 canisters for the life-cycle disposition of LRW. The canisters are stored in the first glass waste storage building, awaiting shipment to the federal repository when it opens. A second glass waste storage building is under construction and will be available in 2006. Shipments to the federal repository are expected to begin in FY 2012.

Over 100 million gallons of waste liquids have been received into the LRW System since the 1950s. The waste is neutralized with caustic, precipitating metals. The waste is allowed to settle, forming a sludge. The salt solution, called supernate is concentrated by evaporation, resulting in the formation of solid saltcake and highly concentrated supernate.

The highest risk onsite is the sludge waste, which is stored in 48 of the remaining 49 underground storage tanks. One tank (Tank 50) has only been used to receive low level waste to date. Sludge waste is 8% of the volume with 3 million gallons and 48% of the radioactivity with 203 million curies. The salt waste is 92% of the volume with 34 million gallons and 52% of the radioactivity with 223 million curies. The primary radioactive waste component is cesium. The salt waste is in two forms: hard salt cake and liquid supernate. The 17 million gallons of hard salt cake has 46% of the volume and only 3% of the radioactivity with 12 million curies. The 17 million gallons of liquid supernate is 46% of the volume and has 50% of the radioactivity with 211 million curies.

LRW has been or currently is stored in 50 of 51 underground tanks in F and H Areas. Two of the 51 tanks have been emptied and operationally closed under the South Carolina Department of Environmental Control (SCDHEC) regulatory authority and three more are empty. Each tank can hold between 750,000 and 1.3 million gallons. Twenty-seven of the tanks meet secondary containment standards, with double walls and no leakage history. Twenty-four tanks are considered "higher risk" as they are up to 50 years old, single-walled, and most have some history of leakage. However, none are currently leaking.

Planned End State (PES)

The end state for the insoluble sludge is for the sludge to be washed and converted into borosilicate glass in DWPF in S Area. This glass is stored in canisters, which will be shipped offsite to the federal repository, when available. Currently these filled canisters are being stored in the Glass Waste Storage Building in S Area.

A complete discussion of the DWPF and Glass Waste Storage Building end state can be found in the *Defense Waste Processing Facility Final*

Environmental Impact Statement, DOE/EIS-0082 and the Defense Waste Processing Facility Final Supplemental Environmental Impact Statement, DOE/EIS-0082-S.

The soluble waste (supernate and dissolved saltcake) will be treated by a number of processes to remove the majority of the radioactive constituents. The highly radioactive component will be sent to the Defense Waste Processing Facility and combined with the sludge for vitrification. The low radioactive component will be sent to the Saltstone Facility for conversion to grout and disposal as low level waste onsite. The 34 million gallons of salt waste (17 million gallons of supernate and 17 million gallons of saltcake) when dissolved and properly adjusted for treatment results in approximately 84 million gallons of waste for processing.

SRS is utilizing a two phase, three step strategy for treating and disposing of salt waste. From 2005 through 2009, SRS will utilize the Deliquification, Dissolution, and Adjustment (DDA) process to treat limited quantities of salt waste for disposal in the Saltstone vaults. The DDA process involves the draining of the cesium-bearing supernate from some of the lowest curie-content saltcake in the waste tanks followed by dissolution of the solid saltcake, settling of the salt solution, and chemical adjustment of the solution prior to transfer to the Saltstone vaults for disposal as a low level waste grout.

From 2006 through 2009, SRS will also utilize the Actinide Removal Process (ARP) and the Modular Caustic Side Solvent Extraction Unit (MCU) to treat limited quantities of salt waste for disposal in the Saltstone vaults. The ARP will use monosodium titanate (MST) to remove actinides and strontium from the salt solution. The waste will then be transferred to the MCU where the cesium will be removed using the caustic side solvent extraction (CSSX) process.

The decontaminated salt solution will then be disposed of as low level waste in the Saltstone vaults. The actinides, strontium, and cesium will be transferred to the DWPF for vitrification.

Together, the DDA and ARP/MCU processes will treat approximately 10 million gallons of salt waste out of the approximately 84 million gallons of properly adjusted salt waste.

Starting in approximately 2009, SRS will utilize the large scale Salt Waste Processing Facility (SWPF) to treat the salt waste. This facility is currently being designed, and construction is expected to begin in 2006. This facility will remove the large majority of the radioactivity from the salt waste and transfer it to DWPF for vitrification with the decontaminated salt waste being sent to the Saltstone Facility for disposal as low level waste. The SWPF utilizes MST to remove actinides and strontium and uses the CSSX process to remove cesium.

After waste is removed, the tanks will be closed by grouting them in place. A complete discussion of the LRW Tank closure end state can be found in the *High Level Tank Closure Final Environmental Impact Statement, DOE/EIS-0303*

Plans are to operate both the DWPF and SWPF until 2019, and canister shipments to the federal repository are planned to be completed in FY 2020.

At the Saltstone Facility, the aqueous salt waste is mixed with flyash, slag, and cement and poured into concrete vaults to solidify. The Saltstone Disposal Facility, located in Z Area, is an engineered disposal facility with low water permeability and non-leaching qualities. The final product is non-hazardous, meeting Nuclear Regulatory Commission (NRC) Class C limits, and the groundwater is protected to drinking water standards.

A complete discussion of the salt waste treatment and disposal strategy can be found in the *Salt Processing Alternatives Final Supplemental Environmental Impact Statement, DOE/EIS-0082-S2*.

Risk

There is a risk at SRS with the interim storage of liquid radioactive waste. The major threat is from radioisotopes migrating from the LRW in a leaking tank to the groundwater. The environmental hazard associated with storing liquid radioactive waste in 50-year old underground carbon steel tanks is reduced by over 99.9% by removal of the waste in the storage tanks and vitrification of this waste in DWPF. The robust waste form created (solid glass matrix inside a welded stainless steel canister) is suitable for indefinite long term storage with extremely low potential for any adverse environmental impact.

Controls

Full project management controls are applied to the disposition of LRW. Included in the control activities is an integrated plan encompassing all the LRW facilities and their interrelated flow paths. Waste management activities for monitoring, moving and processing the LRW in the underground tanks are under a disciplined safety basis with associated controlled documents. Procedures are in place to transfer liquid from any tank and annulus to another tank if a leak occurs.

References

- *High Level Waste System Plan, Rev.13, HLW-02002-00025*
- *PMP Supplement to the High Level System Plan, Rev.13, HLW-2002-00161*
- *Defense Waste Processing Facility Final Environmental Impact Statement, DOE/EIS-0082*

- *Defense Waste Processing Facility Final Supplemental Environmental Impact Statement, DOE/EIS-0082-S*
- *SRS Federal Facility Agreement (Section IX for High Level Waste)*
- *Defense Waste Processing Facility Safety Analysis Report, WSRC-SA-6, Rev.17*
- *Defense Waste Processing Facility Glass Production Control Program, WSRC-IM-91-116-6, Rev. 2*
- *Salt Processing Alternatives Final Supplemental Environmental Impact Statement, DOE/EIS-0082-S2*
- *High Level Waste Tank Closure Final Environmental Impact Statement, DOE/EIS-0303, May 2002*
- *Closure Plan and Performance Assessment for F- and H-Area High Level Waste Tank Systems – Preliminary Draft, Revision 2, August 14, 2000*
- *Industrial Wastewater Closure Plan for F- and H-Area High Level Waste Tank System, WSRC-2003-00498, August 16, 2004*
- *Emergency Preparedness Hazard Assessment for the Concentration, Storage and Transfer Facilities, S-EHA-G-00002, Rev 6, April 2004*

4.2.6. Hazard: Transuranic (TRU) Waste

Hazard Description and Current Status

Transuranic (TRU) waste is a contained hazard at SRS.

This waste is stored at SRS on above ground storage pads (covered and uncovered). TRU waste is containerized on the storage pads in 55-gallon drums, standard waste boxes, concrete culverts, large steel boxes and other miscellaneous size containers. A small portion of TRU waste is stored on a concrete pad and covered with three feet of soil.

At the beginning of calendar year 2005, SRS's volume of stored TRU waste was approximately

8,000 cubic meters, consisting of 15,000 fifty-five-gallon TRU waste drums and 3,000 large containerized boxes. SRS is shipping the waste to the Waste Isolation Pilot Plant (WIPP) at an average rate in excess of a 1,000 cubic meters per year with the plans to complete the shipments of currently stored TRU waste by 2010.

TRU waste is primarily waste contaminated with plutonium-238 and plutonium-239 transuranic nuclides that has been generated at SRS over the past 30 years as a result of the radiochemical separations processes, analytical process control laboratories, and laboratory research activities. In addition, a small quantity of TRU waste at SRS came from offsite facilities. The waste is primarily debris waste (in a solid form) including job control waste such as equipment, piping, and glove boxes.

The plutonium-238 TRU waste presents a repackaging challenge due to contamination control, heat generation, and prevention of worker exposure. This waste is highly dispersible and is approximately 500 times more difficult to contain than plutonium-239. The heat generation and alpha emissions degrade the organics. It is also approximately 280 times more radioactive than plutonium-239. Due to the high worker risk associated with excavation and repackaging the plutonium-238 contaminated TRU waste, the SRS end state vision includes an evaluation of an alternative end state (See Appendix B, *Alternative End States and Recommendations*).

Planned End State (PES)

All SRS TRU waste (and any mixed TRU) will be packaged and shipped off site to the WIPP, federal repository for permanent disposal.

This is required by, and consistent with, the Land Withdrawal Act, Public Law 102-579, the guiding legislation for WIPP.

Risk

The risk of TRU waste is the waste inside the containers escaping and/or breaching their containers and coming in contact with the site workers and the environment. The risks include the unlikely event of the waste inside the drums catching fire and creating a cloud of smoke containing plutonium-238 and plutonium-239 particulates that travel in the area and spread to other areas of the site. There is little risk to an offsite individual and the public.

The risks of storing and handling TRU waste is contained and managed by a combination of 1) requiring workers who handle TRU waste to be trained, 2) requiring operating procedures to be used to handle and store waste, and 3) requiring engineered and safety controls to be in place.

Controls

Some examples to control and contain the risk include limiting the number of TRU waste containers that can be stored on a pad. The site requires TRU waste with higher activity of plutonium-238 and plutonium-239 to be placed in robust concrete converts. Other requirements are to limit personnel and vehicles on TRU waste storage pads and to conduct routine inspections on the TRU waste containers for signs of container integrity and improper storage of the waste.

These controls are established through engineering and safety evaluations and preparation of documents and calculations.

Some key documents include the SAR, DSA, and TSR. The above documents are used to establish the controls to contain the hazard and manage the associated risks.

References

The following are applicable for TRU, LLW, Mixed LLW and Hazardous Waste. TRU waste is the bounding hazard.

- *Solid Waste Management Facility Safety Analysis Report*, WSRC-SA-22 Rev. 4, May 2003
- *Solid Waste Management Facility Safety Technical Safety Requirements*, WSRC-TS-95-16, Rev. 5, July 2004
- *SRS Waste Acceptance Criteria Manual*, WSRC-1S (for all solid waste types) establishes all waste acceptance criteria storage limits, storage containers requirements.
- *Radiological Performance Assessment for the E Area Low Level Waste Facility*, WSRC-RP-94-218 established radio-nuclide limits for LLW onsite disposal
- *Radioactive Waste Management Basis (RWMB)* establishes the requirements for handling and storage of any radioactive waste. RWMB is specific for each facility

4.2.7. Hazard: Low Level Waste

Low-level waste (LLW) is a contained hazard at SRS.

LLW waste is radioactive waste that is not classified as liquid radioactive waste, transuranic waste, mixed waste, spent fuel or by-product material. It usually contains small amounts of radioactive waste dispersed in large quantities of material. Typical low-level waste consists of used protective clothing, rags, tools and equipment, used resins and residues, dirt, concrete, construction debris and scrap metal. LLW does not contain Resource Conservation and Recovery Act (RCRA)-regulated hazardous waste.

Solid Low Level Waste

Hazard Description and Current Status

Solid LLW consists of job control waste (contaminated tools, rags, clothing, etc), rubble from destruction of buildings, contaminated equipment (tanks, valves, air duct, etc.) and Naval Reactor components from nuclear submarines. The site has generated approximately 25,000 cubic meters (m³) of solid LLW per year since 2004.

SRS has reduced the amount of legacy solid LLW from over 3,000 m³ at the end of FY 2002 to its current state of only 23 m³. The remaining legacy waste will be disposed of by the end of FY 2005. At that time, the site will actively dispose of solid LLW as it is being generated.

Solid LLW is first sorted, segregated (separated by type and amount of radioactivity), and, in some cases, volume reduced. It is then packaged and disposed of according to its nature and characterization. Selection of the appropriate treatment option and/or disposal facility is based on the waste characterization and form. Solid LLW is disposed on site using four different options: the Low Activity Waste Vaults (LAWV), the Intermediate Level Vaults (ILV), Engineered Trenches or the "slit" trenches. Solid LLW is also shipped offsite to a federal or commercial disposal facility depending on the radionuclide content and quantity.

In the past, solid low-level waste was disposed of in the Low-Level Radioactive Waste Disposal Facility (LLRWDF, previously called the Low-Level Burial Grounds). The LLRWDF was closed (capped) under RCRA in 1999, and no longer accepts waste for disposal. However, SRS will continue monitoring the groundwater beneath the LLRWDF to detect any radioactivity that might migrate from the disposal facility.

SRS uses engineered concrete vaults for the permanent disposal of solid LLW.

Radionuclides that require a better isolation from the environment are placed in these vaults. These vaults are located in the E-Area Low Level Waste Facility (LLWF).

SRS disposes solid LLW with extremely low radioactive content in Engineered Trenches and in slit trenches. The Engineered Trenches measure 650 feet in length by 150 feet wide and are utilized primarily for containerized waste. The trenches are equipped with a sump and pump system (including sample station) to manage anticipated rainfall. The trenches are also equipped with a vadose zone monitoring system (VZMS) installed around the perimeter.

The slit trenches are approximately 20 feet wide by 600 feet long. These trenches are also used for very low activity waste primarily from the destruction of onsite buildings (concrete rubble). The slit trenches are also equipped with vadose zone monitoring systems.

SRS uses another method for disposal of equipment that is physically too large for vault disposal and contaminated at high enough levels to require vault type isolation. The technique, called "components-in-grout," consists of placing the item on a one-foot thick grout base, filling any void space with special formulation grout, and grouting around the item using the trench walls as a form. This technique allows for the disposal of large legacy equipment that is classified as solid LLW, as well as any newly-generated waste, without having to build new vaults.

Planned End State (PES)

Solid LLW that is disposed of at SRS will be a residual hazard. However, the closure of the facility will include a multi-layered cap that will reduce the infiltration of rainwater and the mobility of the radionuclides to the aquifer. The facility will be monitored closely for compliance to groundwater standards and will remain

protected from general public intrusions. If noncompliance is discovered, remediation of the site would be implemented.

The Atomic Energy Act authorizes DOE to manage LLW. This planned end state meets the performance requirements of DOE Order 435.1, *Radioactive Waste Management*, ensuring protectiveness of human health and the environment.

Risk

The solid LLW currently being disposed of at SRS contains various radionuclides. This waste will eventually decompose and release the radionuclides into the environment. Some of the radionuclides have short half-lives and will not be a risk because of this natural attenuation. The other radionuclides are managed (amounts are limited) to ensure they do not exceed specific requirements identified in DOE Orders and/or state regulations that are protective of human health and the environment. Groundwater and intruder modeling of the waste has been performed and is continuously evaluated to ensure the public and the environment are protected. To ensure the modeling is conservative, groundwater and vadose zone monitoring are performed and evaluated at least annually.

Controls

Waste acceptance criteria (WAC) are established for each disposal facility (vaults and trenches). It establishes the quantity of radionuclides allowed for a package to ensure the public and environment are protected. These WACs are based upon the Performance Assessment modeling of groundwater and intruders.

References

- *Manual 1S, SRS Waste Acceptance Criteria Manual*, Revision 9, January 14, 2005

- *Radiological Performance Assessment for the E-Area Low-Level Waste Facility*, WSRC-RP-94-218, Revision 1, January 31, 2000

Liquid low-level waste

Hazard Description and Current Status

Liquid LLW is a contained hazard at SRS.

Liquid low-level waste is a by-product of the separations process and tank farm operations. This waste is treated on site by several methods, depending upon its nature.

The Effluent Treatment Project (ETP) collects and processes low-level radioactive and chemically contaminated wastewater from both the High-Level Waste Tank Farm Evaporator overheads and from reprocessing facility evaporators. ETP treats liquid low level waste for discharge to a National Pollutant Discharge Elimination System (NPDES) permitted outfall, effectively capturing all chemical and radioactive contaminants except tritium. The state-of-the-art process at ETP includes pH adjustment, submicron filtration, organic removal, reverse osmosis and ion exchange. ETP replaced the seepage basins that were used until November 1988.

Concentrated liquid waste from the ETP evaporators is further treated at the SRS Saltstone Facility. At this facility, the waste stream undergoes a cement grout immobilization process, after which the waste form is classified as low level waste.

After the waste is received at Saltstone, the liquid salt solution is mixed with cement, fly ash and furnace slag to form a grout. The resulting grout is disposed by pumping it to engineered concrete vaults. Here, it cures into stable concrete (called "saltstone," hence the name of the facility). After filling, the vault is capped with clean concrete to isolate it from rain and

weathering. Final closure of the area consists of covering the vaults with a clay cap and backfilling with earth. Extensive testing shows that any waste constituents leached from the saltstone will remain within Environmental Protection Agency drinking water standards. Wells near the edge of the disposal site are used to monitor groundwater to ensure that it meets standards established by the South Carolina Department of Health and Environmental Control.

Construction of the Saltstone Facility and the first two vaults were completed in July 1988. The main process waste stream that Saltstone was designed to process is the high-volume, low-activity waste stream from the LRW pre-treatment process. The Saltstone facility has been in suspension since 1999 because of the decision to seek an alternative process to prepare liquid radioactive waste solutions for DWPF and Saltstone. Suspension of the facility reduces costs while minimizing potential deterioration of the plant. This action helps support future operations of the plant and minimizes the cost to restart the facility in the future.

The Effluent Treatment Project (ETP) has water treatment chemicals that are stored in diked 10,000-gallon tanks. These tanks contain sodium hydroxide or nitric acid. In addition there are other small amounts of oxalic acid and aluminum nitrate stored in chemical storage areas for further water treatment.

Currently the ETP treats between 10 and 25 million gallons of wastewater per year.

Planned End State (PES)

The ETP will be decommissioned consistent with the other excess EM facilities, and consistent with the closure of the H-Area.

Risk

Residues upon closure will be removed and neutralized as needed.

Controls

WAC is established for the ETP and establishes the type and quantity of radionuclides and chemicals allowed into the facility for treatment to ensure the public and environment are protected. These WACs are based upon the Performance Assessment modeling of groundwater and intruders as well as discharge permits granted to the ETP by the State of South Carolina.

References

- *F/H Tank Farms Waste Compliance Plan for Transfers to the Effluent Treatment Facilities*, WSRC-TR-99-00009, latest revision as amended
- *LWD/WS Projects Safety Basis Manual*, WSRC-IM-94-10, dated January 6, 2005
- *Emergency Preparedness Hazard Assessment for the Consolidated Incinerator Facility, Effluent Treatment Facility, and Saltstone Facility*, S-EHA-G-0004, Rev. 3, Dated September 2003..

4.2.8. Hazard: Mixed WasteHazard Description and Current Status

Mixed Low-Level Waste is a contained hazard at SRS.

Mixed Low-level waste (MLLW) is a low-level waste (LLW) as defined in Section 4.2.7, *Low Level Waste* in this chapter, which also contains a hazardous component subject to the Resource Conservation and Recovery Act (RCRA) or the Toxic Substances Control Act (TSCA).

Therefore, MLLW is managed in accordance with the requirements of RCRA, TSCA and

DOE Order 435.1, *Radioactive Waste Management*.

Early site practices dispositioned some MLLW in an onsite facility referred to as the Mixed Waste Management Facility. This facility, located in E Area, was closed in 1990 under RCRA requirements and is now under post-closure care. Presently, new MLLW is stored onsite for less than one year per RCRA and is permanently disposed offsite via commercial vendors. MLLW is stored in RCRA-permitted facilities at the E-Area Solid Waste Management Facility, H-Area Solvent Storage Tanks, and the N-Area Hazardous/Mixed Waste Facilities. Legacy MLLW is being treated, primarily offsite, in accordance with schedules contained in the *Site Treatment Plan* and then disposed offsite in a commercial disposal facility while newly generated MLLW is typically treated and disposed offsite within one year from time of generation.

SRS currently has approximately 400 cubic meters of legacy MLLW in both solid and liquid forms.

SRS is on schedule to disposition all legacy waste by the end of FY 2007, at which time the MLLW project will be in steady-state, meaning MLLW generated will typically be treated and disposed within one year.

See Figure 4.4, *Waste Management* for more details.

Planned End State (PES):

All legacy mixed waste will be disposed of in compliance with applicable regulations and requirements. SRS newly generated waste resulting from the EM cleanup project will be disposed as the waste is generated to prevent a legacy problem from being created for future generations. When at the end state, residual hazards will be minimal because the low volume and age of waste in storage will greatly reduce

the possibility for releases. At this time all MLLW operations will be consolidated within the Solid Waste Management Facility in E Area. The *Performance Management Plan* (PMP) and the current contract between DOE and WSRC drive the MLLW project to steady-state well before the end state of 2025 through contract incentives. After 2025, waste management activities will be transitioned to a new landlord.

Risk:

Risk associated with the MLLW project includes an uncontrolled release of a hazardous and/or radioactive substance to personnel or the environment. An uncontrolled release could impact the soil, air, and/or groundwater and direct exposure to either unprotected workers or the public to such hazards could result in detrimental health affects.

Controls

Risks associated with MLLW storage are mitigated by strict compliance with the requirements delineated in Title 40 Code of Federal Regulations (CFR) and Title 10 CFR 835. These regulations protect the worker, public, and environment from both hazardous materials and ionizing radiation. They are locally administratively implemented by site specific operating procedures and the facility waste acceptance criteria. Risks are physically managed through strict confinement by only storing MLLW in approved engineered containers followed by inspections, per procedures. These containers are stored within RCRA-permitted facilities providing secondary confinement with impermeable floor coatings and sumps for containing any potential spills.

Depending on the nature of the hazardous material, airborne emissions may also require specialized control measures such as filtration and/or ventilation. These controls protect workers, the public, and the environment from

stored MLLW. During active management activities such as characterization or repackaging, workers are further protected with specialized personal protective equipment and engineered support equipment.

References

- *HW/MW Area Inspections* (U), SW 15.6-INP-HWMW01, Rev. 8
- *Routine Inspections for the Hazardous Waste/Mixed Waste Facility* (U) SW 15.6-INP-HWMW02, Rev. 7
- Procedure Manual 1S, *SRS Waste Acceptance Criteria Manual*, WAC 3.18 Rev. 4, 02/01/02

4.2.9. Hazard: Hazardous Waste

Hazard Description and Current Status:

Hazardous waste is a contained hazard at SRS.

Hazardous waste is a waste containing a hazardous component subject to the RCRA or TSCA. Currently, hazardous waste is stored in RCRA-permitted facilities at the N-Area Hazardous/Mixed Waste Facilities. Legacy hazardous waste generated prior to the Land Disposal Restriction effective date is being treated in accordance with schedules contained in the latest site contract as reflected in the current PMP.

SRS currently has approximately 60 cubic meters of legacy hazardous waste in both solid and liquid forms. SRS is on schedule to disposition all legacy hazardous waste by the end of FY 2006 at which time the hazardous waste project will be in steady-state, meaning waste generated will typically be treated and disposed within one year. Newly generated hazardous waste is typically stored onsite for less than 12 months, per RCRA regulations, and sent for permanent treatment and disposal offsite via commercial vendors.

Planned End State (PES):

All legacy hazardous waste will be disposed of in compliance with applicable regulations and requirements. SRS newly generated waste resulting from the EM cleanup project will be disposed as the waste is generated to prevent a legacy problem from being created for future generations. When at the end state, residual hazards will be minimal because the low volume and age of waste in storage will greatly reduce the possibility for releases. At this time all hazardous waste operations will be consolidated within the Solid Waste Management Facility in E Area, which is located in the center of SR. As stated above, the PMP and current contract drives the hazardous waste project to steady-state by FY 2006, well before the end state of 2025 by using contract incentives. After 2025, waste management activities will be transitioned to a new landlord.

Risk:

Risk associated with the hazardous waste project would be an uncontrolled release of a hazardous substance to the environment. An uncontrolled release could impact the soil, air, and/or groundwater and direct exposure to either unprotected workers or the public to such hazards could result in detrimental health affects.

Controls

Risks associated with hazardous waste storage are mitigated by strict compliance with the requirements delineated in Title 40 CFR. These regulations protect the worker, public, and environment from hazardous materials and are locally administratively implemented by site specific operating procedures and the facility waste acceptance criteria. Risk is physically managed through strict confinement by only storing hazardous waste in approved engineered containers followed by inspections, per

procedures. These containers are stored within RCRA-permitted facilities providing secondary confinement with impermeable floor coatings and sumps for containing any potential spills. Depending on the nature of the hazardous material, airborne emissions may also require specialized control measures such as filtration and/or ventilation. These controls protect workers, the public, and the environment from stored hazardous waste. During active management activities such as characterization or repackaging, workers are further protected with specialized personal protective equipment and engineered support equipment.

References

- *HW/MW Area Inspections* (U), SW 15.6-INP-HWMW01, Rev. 8
- *Routine Inspections for the Hazardous Waste/Mixed Waste Facility* (U), SW 15.6-INP-HWMW02, Rev. 7
- Procedure Manual 1S, *SRS Waste Acceptance Criteria Manual*, WAC 3.18 Rev. 4, 02/01/02

4.2.10. Hazard: Sanitary WasteHazard Description and Current Status

Sanitary waste is a contained hazard at SRS.

Sanitary waste generated at SRS is typical municipal solid waste as governed by EPA-RCRA Subtitle D. SRS generates approximately 1000 tons per month. This includes deactivation and decommissioning (D&D) waste going to Three Rivers Solid Waste Authority landfill (TRSWA) located on site. Currently, all sanitary waste is being disposed onsite. No waste is being disposed offsite. The construction and demolition (C&D) landfill located in G area near central shops receives an additional approximately 3000 tons per month.

Planned End State (PES)

Sanitary waste will continue to be generated while there are people working at SRS. D&D waste will be generated based on the level of activity of the program. TRSWA will operate for approximately fifty years or until the landfill has met its permitted limits. This landfill, located on SRS, serves the site and nine surrounding counties. It complies with all EPA-RCRA Subtitle D requirements. Closure and post closure responsibility is for thirty years. Once closure monitoring for 30 years is complete (after the landfill stops receiving waste), the property reverts to Department of Energy Savannah River (DOE-SR) responsibility for long term stewardship.

Closure activities at the C&D landfill will begin once the landfill stops receiving waste. This includes placing a three foot clay cover over the landfill and establishing a permanent grass cover. Institutional control for the C&D landfill will be included in the long term stewardship program at SRS.

Risk

The risk from this program is to the groundwater. Both the TRSWA and the C&D landfill have the potential to impact the ground water. The TRSWA accepts typical chemicals and metals, as do all municipal landfills. The C&D landfill may have contaminants from construction debris.

Controls

TRSWA has a protective plastic liner under the landfill as required by RCRA Subtitle D. The C&D landfill does not have a protective liner, but the landfill restricts acceptance to mostly inert materials. At the end of the useful life of both landfills, they will be closed, as discussed in the Planned End States.

References**Waste Certification**

- WSRC 1S Manual, *SRS Waste Acceptance Criteria Manual*
- SW 18 Manual, *Solid Waste and Infrastructure Manual*

P2 Program:

- WSRC 3Q Manual, *Environmental Compliance Manual*
- Manual E7, *Conduct of Engineering Manual*

Sanitary Waste

- WSRC Manual 3Q, *Environmental Compliance Manual*
- WSRC 1S Manual, *SRS Waste Acceptance Criteria Manual*

4.2.11. Hazard: EM FacilitiesHazard Description and Current Status

EM facilities are a contained hazard at SRS.

There are three major classifications for the facilities at SRS based on the significance and quantities of nuclear materials contained within them. At the end of CY 04 there were 139 nuclear facilities, 37 radiological facilities, and 646 other industrial facilities remaining to be deactivated and decommissioned by the EM Cleanup Project. In addition to radiological hazards, these facilities contain a variety of chemical and industrial hazards including but not limited to, asbestos, acids, caustics, solvents and other organics, Freon, open pits and sumps, and stored energy sources such as counter weights and charged springs. At the end of their mission, the facility hazard classifications will be downgraded through the steps of shutdown, de-inventory, deactivate, and decommission. In this process the hazards will either be removed or immobilized to reach the facility's decommissioned end state.

There are numerous facilities, such as the reactor facilities that at the end of their mission, completed the shut down and de-inventory steps. These facilities are maintained in a storage state until deactivation and decommissioning can proceed. New missions have been placed in some of these facilities such as C and K Reactors.

EM Facilities includes closing the LRW tanks and industrial, radiological and nuclear facilities. Once a facility's mission is complete, the facility is deactivated and placed in interim safe storage or decommissioned to its end state. The end state may be either in-situ disposal or demolition unless reused to support other long-range federal missions at SRS or designated for historical preservation or economic development. In-situ disposal is applicable for hardened, contaminated facilities such as reactors, basins, canyons, tanks, and other facilities such as river water basins and lift stations. The rationales for this option include the following:

- Location is acceptable for in-situ disposal.
- Removal of the risk outweighs the benefits.
- Facility meets regulatory requirements for acceptable, long-term risk to the public and the environment.

Demolition is appropriate for non-hardened contaminated facilities or non-hardened, uncontaminated facilities. Examples include Canning Building (313-M) or administrative buildings. The rationales for this option include the following:

- Facility is not a candidate for in-situ disposal.
- Contaminants may be chemicals and radionuclides.
- Degradation of the facility will lead to rising surveillance and maintenance costs.
- Demolition costs are relatively low.
- The salvage value off-sets demolition cost.
- Demolition avoids future regulatory exposure.

Current plans are for 857 facilities to be demolished and 105 facilities to have in-situ disposal. All of the remaining 49 LRW tanks are planned to undergo in situ disposal. However, this list is being re-evaluated as a result of the *Savannah River Site's Cold War Built Environment Cultural Resources Management Plan (CRMP)*.

The *CRMP* contains the process for reaching decisions concerning the future treatment of SRS Cold War National Register of Historic Places (NRHP)-eligible historic properties, taking into account their historic significance, integrity, future interpretation, and treatment. The *CRMP* was developed as a result of the *Programmatic Agreement (PA) Among the U. S. Department of Energy (DOE), the State Historic Preservation Office (SHPO) and the Advisory Council on Historic Preservation (ACHP) for the Management of Cold War Historic Properties on the Savannah River Site (SRS), Aiken, Barnwell, and Allendale Counties, South Carolina*.

Area Closure as scheduled in Appendix E of the Federal Facility Agreement (FFA) is the key driver for sequencing/scheduling D&D scope.

The drivers for this program include DOE Policy 430.1, *Land and Facility Use Planning*, DOE Guidance 540.1-4, *Decommissioning Implementation Guide* and *Savannah River Site's Cold War Built Environment Cultural Resources Management Plan (CRMP)*. Regulator involvement through the Core Team (see Section 4.3.12, *Hazard -- Soil and Groundwater*) helps to implement the July 2003 *Memorandum of Agreement for Achieving an Accelerated Cleanup vision for the Savannah River Site*.

Planned End State (PES)

The end state vision for the D&D program is that SRS remains a federal property with a central core area, surrounded by an environmental buffer zone. Facilities within the central core will be

turned over for NNSA mission-related operations, deactivated to an appropriate condition for long-term storage or decommissioned. However, some facilities may be considered historic properties and will be managed in accordance with the Programmatic Agreement among the U. S. Department of Energy, the State Historic Preservation Office, and the Advisory Council on Historic Preservation for the Management of Cold War Historic Properties on the Savannah River Site, Aiken, Barnwell, and Allendale Counties, South Carolina. Other facilities may be considered for economic development. Remaining facilities outside the central core will be deactivated to an appropriate condition for long-term storage or may be decommissioned and eventually turned over to NNSA mission-related operations. By 2006 the decommissioning of facilities in T, D and M Areas will be complete.

The *SRS EM Integrated Deactivation and Decommissioning Plan* was developed as a tool for planning and accelerating closure of EM facilities, waste tanks, and inactive waste sites from 2003 – 2025. The plan assumes no programmatic reuse of any site facilities, including infrastructure by DOE or other federal program, nor does it account for any historic facilities or economic development. The plan reflects guidance from the *DOE EM Program Performance Management Plan, Top-to-Bottom Review*, DOE guidance regarding risk-based ranking, and DOE/Westinghouse Savannah River Company (WSRC) Contract Modification 100. The plan also documents the planned EM end states for facilities, waste tanks, and inactive waste sites. Reflecting its comprehensive purpose, the D&D plan integrates strategic plans from SRS programs, maintains a repository of facility information, including rough order-of-magnitude (ROM) cost estimates, hazard category, and end state; and provides a methodology for the scheduling of facility closure, based on economic, health and safety, and programmatic risks. This information in

combination with mission, budget, regulator influence and agreements, and strategic objectives will dictate the execution strategy for facility D&D.

Each area description has an EM Facility D&D table (see Section 4.4, *Hazard-Specific Discussion by Areas*) that summarizes the total EM facilities in the area (by facility hazard type, number of facilities and square footage), the current status of D&D completions through FY 2004 (number of facilities where D&D is complete) and the planned 2025 end state for final decommissioning (number of facilities demolished or in situ decommissioned). The D&D end state assumes all EM facilities will be decommissioned, and none will be reused by DOE or other federal program or for historical preservation or economic development. The information presented for facilities in each area was obtained directly from the *SRS EM Integrated D&D Plan* (Rev. 1) and is consistent with the total listing of EM Facilities in the WSRC contract. Additional information related to EM Facility hazard types, conceptual site models and decommissioned end states is available in Appendix K, *Conceptual Site Models for Typical Hazards*.

The majority of the facilities on site will be demolished to the ground level leaving only a clean slab. Contaminants (chemical and/or radiological) will be removed or immobilized such that all transferable contamination is removed, and the calculated risk from the fixed contamination is below the threshold for the industrial worked scenario. The robust structural integrity of the hardened reactor and canyon facilities will be credited for determination of the quantities of contaminants that can remain.

Facility Haz Type	Site Totals		End State	
	No.	Sq Ft	DEM	ISD
Nuc	144	3,916,656	111	33
Rad	38	901,683	30	8
Oth Ind	780	6,541,246	716	64
LRW Tanks	51	N/A	0	51
Total	1013	11,359,585	857	156

Figure 4.2 Site D&D Table

Nuc- Nuclear

Rad – Radiological

Oth Ind – Other Industrial

No. – Number of facilities

Sq Ft – Square Feet

Comp – Complete

Dem – Demolished

ISD – In situ disposal

Risk

At the completion of decommissioning, the facility hazards will either be removed or stabilized such that no new releases are created and the facility end state will support closure of the area by the Soil and Groundwater Project (SCP). To support the Area Closure Program the calculated risk from any remaining contaminants must be below the threshold for the industrial worker scenario.

Controls

During performance of D&D activities, hazards are controlled through implementation of the Integrated Safety Management System (ISMS) based site work practices and requirements. Radiological, chemical, and industrial hazards are tracked and managed throughout the transition from operations, shut down, de-inventory, deactivation, and decommissioning. The end state objective of the D&D program is to remove and/or immobilize hazards such that no new waste units are created and future

controls and monitoring is not required on a facility by facility basis. End states for each facility are integrated with the strategy for area closure which will encompass the overall plan for future controls for the area.

References

- *SRS Environmental Management Program Performance Management Plan, 2005*
- *SRS Environmental Management Integrated Deactivation and Decommissioning Plan, May 2003*

4.2.11.1 Nuclear and Radiological Facility End State Evaluation and Decision-Making

For some nuclear and radiological facilities at SRS, it has been, or will be, determined that complete demolition of the facility is not practical because demolition presents an unacceptable worker risk, is prohibitively expensive, or some other reason, and that a long-term end state can be achieved through in situ decommissioning that is protective of human health and the environment. (“Other industrial” facilities, which are neither nuclear nor radiological, are not included in this discussion.)

These facilities processed or managed radioactive materials and/or wastes, and in some cases it will not be practical to remove all traces of those substances in the deactivation and decommissioning processes. In these cases, some radiological source term will remain after decommissioning. The amount to be left depends on the difficulty, expense, and worker risk associated with removing it, and the long-term human and environmental risk associated with leaving it.

The most fundamental general criterion that a protective facility end state must meet is that it must not pose an unacceptable risk to human health and the environment. Human health risk, as used in cleanup decision making under the Comprehensive Environmental Response,

Compensation, and Liability Act (CERCLA), is essentially a function of two variables: (1) a **hazard**, and (2) **exposure** to the hazard. (See Appendix G, *Land Use, Risk and Cleanup Decision Process*, for more information).

The **hazard** has some key characteristics:

- The kind (or species) of radioactive substance in the facility
- Its rate of decay or attenuation (half-life)
- The amount (source term)
- Its form (fixed or fluid inside piping or ventilation system, in concrete, etc.)
- Its hazardousness or toxicity (dose rate, hazard index for non-carcinogens)

These factors address the nature and magnitude of the hazard.

The risk posed by the hazard remaining in the facility, however, is also a function of human **exposure** to it. In order to estimate risk, and help to inform a decision as to the amount of hazard that can be safely left behind after decommissioning, these factors regarding exposure must be addressed:

- The mode of exposure (How and when will the hazard be released from the decommissioned facility? How robust are the systems containing the hazard, and when will they fail to contain it?)
- The exposure pathway (Must the receptor ingest or inhale the substance to be adversely affected by it, or is there a direct radiation pathway?)
- The point of exposure (Where the groundwater discharges to a stream? At a groundwater well adjacent to the facility? In the soil around the facility? At the facility's boundary or in the air, after the loss of the facility's structural integrity? At the area or SRS boundary?)
- The potential receptor (Full-time industrial workers in the vicinity, or workers who are in the vicinity of the facility very infrequently to monitor or perform

maintenance? No workers? People exposed to groundwater contaminated by the release—from a well or where it seeps to the ground surface or into a stream?)

- Other sources (hazards) nearby that can add to any adverse effect

These factors related to the hazard and possible exposure constitute key assumptions of the risk assessment. A range of feasible end state alternatives is also needed. Only data relevant to the feasible alternatives is collected, and only risks relevant to feasible alternatives are estimated. The risk assessment will clearly identify who and where the potentially affected receptor is, the exposure pathway, and the risk to the receptor, for each potential end state.

Stakeholder review of these assumptions and feasible alternatives should occur before risk assessment so that the risk assessment is viewed as credible and the associated uncertainties in the risk assessment are identified and understood.

(Note—not all “data gaps” are uncertainties; only those that make it difficult to estimate risk with a useful degree of accuracy, or difficult to compare the relative protectiveness of the end state alternatives, are critical uncertainties that should be reduced by additional data or modeling, or in some cases by selecting an end state that makes the uncertainty less important [such as complete removal of the source]).

Depending on the regulatory framework under which the decommissioning is being preformed, EPA and SCDHEC will also be reviewing the assumptions and methods of the risk analysis, and the range of alternatives considered feasible.

When the feasible end states and potential receptors have been identified, and risks have been estimated, they must be evaluated. For an end state alternative to be found acceptable, or

preferable to the others, the following factors related to the risk associated with the end state alternatives must be addressed:

- The standard for protectiveness (What is the least protectiveness [i.e., greatest risk] to the potential receptor that is acceptable?)
- The applicable regulatory standard, if any (Is it a groundwater contamination limit, a surface water limit, a risk- or dose-based limit to a human or ecological receptor? A limit in a DOE Order?)

These standards of protectiveness should be stakeholder reviewed and understood prior to a decision on a decommissioning end state.

The decommissioning end state may be achieved by DOE through a removal action, under DOE's lead agency authority, documented in an Engineering Evaluation/Cost Analysis that is subject to regulator and public review; or the decommissioning end state decision may be selected through the CERCLA remedial process and documented in a Record of Decision for the facility or for the Area Completion (which can include multiple non-clean facilities and/or soil contamination release sites listed in the FFA for assessment and cleanup.) In any case, the basis for the end state decision, including the results of risk and/or performance assessment and feasibility evaluation, will be explained in whichever decision document is issued.

In some cases, this scoping of risk-, protectiveness-, and feasibility-related factors will take place early in the planning for Area Completion. The characterization and decision making will follow the general sequence shown in Chapter 1, Figure 1.3, *Basic Area Completion Process*. In other cases, the facility decommissioning planning will take place earlier or later than that for the area but will

have stakeholder review consistent with the *SRS Community Involvement Plan* (May 2005).

4.2.12. Hazard: Soil and Groundwater

Hazard Description and Current Status

Soil and groundwater are being remediated due to released hazards at SRS.

Originally, SRS had 515 waste units – both soil and groundwater. Of these, 497 were surface units and 18 groundwater units. Of the surface units, 318 have remediation complete, 138 are in assessment and 48 are in remediation.. A portion of the surface units also have a groundwater component. Five of the groundwater remediations are complete, six are in assessment, and seven are in remediation.

As part of the Soil and Groundwater Project Risk Evaluation Process, the following risk factors are considered:

- toxicity hazard and extent of contamination
- migration and mobility of contaminants
- similarities of source term
- geographic location, including proximity to operating facilities and to the site boundary
- future land use
- regulatory commitments and expectations.

To facilitate the acceleration of risk reduction, a core team of regulators, Department of Energy – Savannah River (DOE-SR) and WSRC staff members serves as the basis for closure acceleration. This group strives to 1) facilitate effective and efficient risk management and remedial selection decisions; and 2) streamline the administrative process (i.e., regulatory documentation), whenever possible. These environmental restoration activities are being sequenced with decommissioning activities to support objectives of closing site areas to delete them from the National Priorities List (NPL).

Planned End State (PES)

All SRS soil remediations are currently and projected to accommodate the Comprehensive Environmental Response, Compensation and Liability Act (CERCLA) cancer risk assessment levels of either less than one in a million (less than 10^{-6}) for a residential (unrestricted) scenario or between a one in ten thousand to one in a million (10^{-4} to 10^{-6}) industrial worker scenario with institutional controls. A corollary approach is implemented for non-cancer risk (presented in terms of hazard indexes) but is not presented to simplify SRS's end state concept. Evidence of this is depicted for the completed units on Tables 4.1a, *Planned End State By Watersheds (G Area Only)*, and 4.3a, *SRS End State Vision Planned by Area* in Appendices I, *Watershed Conceptual Site Models and Hazard Tables* and J, *Area Conceptual Site Models and Hazard Tables*, with the end state for all complete SGP units identified by one of the aforementioned risk categories.

SRS water (i.e., groundwater and surface water) hazards and resultant cleanup strategies are based on maximum contaminant limits (MCLs). MCLs are the highest level of a contaminant that is allowed in drinking water which includes the surface or subsurface source of supply. MCLs are enforced through the *South Carolina Primary Drinking Water Regulations* for monitoring, reporting, record retention requirements and public notification. The end state for SRS waters is to remediate the media until such time that it meets MCLs throughout the entire contaminated volume of water. In addition, SRS utilizes Mixing Zones, which are essentially temporary permits to exceed MCLs in a portion of a plume to allow a remedy (active or passive) to have the necessary time to achieve MCLs throughout an aquifer. SRS does not foresee a change to this groundwater remedial strategy. SRS does apply the following graded approach when pursuing the groundwater end state:

- 1) aggressive/active remediation technologies to eliminate or control source of

- contamination (e.g., pump and treat, in situ destruction, aggressive immobilization);
- 2) moderately aggressive remediation alternatives or a combination of active and passive remedial measures for the primary groundwater plume (e.g., barrier walls, recirculation wells); and
- 3) passive and innovative technologies (e.g., monitored natural attenuation, phytoremediation).

This strategy is essential in that it is technically impracticable and cost prohibitive to actively remediate all SRS waters to MCL levels. Furthermore, this strategy maximizes short-term cost expenditures on high concentration/source reduction groundwater contamination and relies on long-term natural, passive means on the least contaminated portion of groundwater plumes.

It is evident that SRS has utilized and benefited from the graded approach when one compares the CERCLA and RCRA waste units that have either Interim or Final Record of Decisions with a component of the remedy that is defined as a Mixing Zone, Monitored Natural Attenuation, and/or passive remediation. These include:

- passive soil vapor extraction with monitoring at Miscellaneous Chemical Basin/Metals Burning Pit and A-Area Burning/Rubble Pits
- mixing zones at D-Area Oil Seepage Basin, Old F-Area Seepage Basin, and L-Area Burning/Rubble Pit/Rubble Pile/Gas Cylinder Disposal Facility
- monitoring at D-Area Burning Rubble Pits, and C, F, K, P-Area Coal Pile Runoff Basins
- monitored natural attenuation at K-Area Burning/Rubble Pit
- passive remediation with natural biodegradation at P-Area Burning/Rubble Pit.

SRS has made gross estimates of the volume of groundwater addressed by these low energy/passive approaches and compared this

volume to a hypothetical active remedy (i.e., pump and treat) applied to the same volume. Applying broad assumptions in support of the comparison, SRS has used these alternative approaches for active remediation to address more than 3 billion gallons of groundwater. To put this quantity in perspective, the National Mall in Washington, D.C., is roughly 309 acres; 3 billion gallons of water would submerge the entire mall to a depth of approximately 30 feet.

Furthermore, SRS has virtually institutionalized the graded approach for all of the groundwater remediations conducted under the RCRA program. These include the following:

- phytoremediation for the Mixed Waste Management Facility Groundwater
- bioremediation with Mixing Zone for the Sanitary Landfill Groundwater
- barrier walls with base injection for the F&H Areas Seepage Basin Groundwater
- passive soil vapor extraction for the A/M Area Groundwater.

These efforts will result in remediation of billions of gallons of groundwater through passive remediation, and/or natural processes in place of more aggressive remediation technologies.

Risk

Soil and groundwater risk is the potential of chemical and/or radiological contamination in

the environmental media to adversely affect human health and the environment.

Controls

Managing this risk includes the following methodologies: identifying the nature of the environmental contamination problem; investigating the extent, fate, and transport of the contamination; evaluating and assessing the risk to human health and the environment; identifying, evaluating, and selecting an appropriate remedial technology; and finally, designing and implementing the selected remedial technology.

References

RCRA and CERCLA are the primary controls that govern hazardous waste and contaminant releases.

The *National Oil and Hazardous Substances Pollution Contingency Plan* and the *Federal Facility Agreement for the Savannah River Site*, WSRC-OS-94-42, 10-2-96 are the primary documents that describe the processes that are implemented to cleanup existing environmental contamination and prevent future contaminant releases to the environment for SRS soil and groundwater waste sites.

Integrator Operable Units (IOUs)

Integrator Operable Units (IOUs) are the surface water bodies draining all six SRS watersheds. As the term implies, IOUs are the integrators, or collection points, of potential contamination discharged to surface water or groundwater, including the Savannah River floodplain and its contiguous wetlands. These units represent possible paths of contamination from SRS activities to offsite receptors and the environment. As such, the IOU program, as established by SRS, is designed to accomplish the following:

- 1) assess their risk levels and any ongoing impact from active and inactive waste units across the site;
- 2) identify and implement any needed early actions; and
- 3) complete final regulatory assessment and monitor previous remedial actions as necessary.

The SRS staff and stakeholders associated with SRS environmental cleanup have long recognized that the five major site streams and their associated flood plains and wetlands, along with the Savannah River Swamp, form primary hydrologic pathways for contaminant migration from SRS to the Savannah River. As far back as 1995, these pathways were identified as IOUs. Each stream is called an IOU because it integrates the effluents from the operable units within its watershed. SRS has six IOUs (Fourmile Branch, Lower Three Runs, Pen Branch, Savannah River Floodplain Swamp, Steel Creek, and Upper Three Runs). Several are contaminated from past releases direct to the streams. In addition, some IOUs receive contamination from past spills, leaks, etc. that impacted groundwater which now outcrops into the IOUs. Working in conjunction with EPA, SCDHEC and the SRS Citizens Advisory Board (CAB), DOE-SR and WSRC established the IOUs as specified Waste Units and included them in Appendix C of the *Federal Facility Agreement (FFA)*. This action formally launched their cleanup and provided a means of tracking progress in their assessment and remediation.

This innovative IOU cleanup approach is based on sound reasoning and strategic planning to accelerate whole area closure. Remediation of the majority of SGP's inactive waste units involves addressing discrete releases requiring specific assessment and various means of remediation. The IOUs augment these actions by providing a common sense approach—to address SRS cleanup by looking at the site on a more comprehensive scale. By focusing on the site's primary tributaries to the Savannah River, the IOUs address the watersheds that make up the whole of SRS's 310-square miles of surface area. The IOUs provide an effective, protective strategy for SGP's cleanup effort. As such, this ongoing assessment and remediation function enables long-term monitoring for the various surface pathways against the potential release of hazardous substances from operable units or facilities within a watershed to other receptors. Further, as early action opportunities are identified, the assessment of these IOUs serves to provide near term protection of human health and the environment.

4.3 Hazard Specific Discussion by Watersheds

There are five main streams that originate on, or pass through the SRS before discharging into the Savannah River/Floodplain Swamp. The SRS hazard evaluation is comprised of the five onsite watersheds (Upper Three Runs, Fourmile Branch, Pen Branch, Steel Creek, and Lower Three Runs) and the Savannah River/Floodplain Swamp, which is the receiving body for the onsite streams. All of these watersheds, including the portion of the Savannah River adjacent to SRS, and the stream/wetlands associated with the IOUs integrate the potential contamination discharged to surface water or groundwater from SRS operations. The IOUs are the primary pathways for offsite transport of site-related contamination. A general site-wide conceptual site model is provided in Figure 4.0, *SRS Sitewide Conceptual Site Model*, located in Appendix I, *Watershed Conceptual Site Models and Hazard Tables*, which depicts sources of contamination and contaminant migration pathways.

The hazard information presented in the following pages is segregated in watershed-level and area-level discussions. The sections are organized to avoid duplication of area hazard information that impact more than one watershed. G-Area (general site) hazards (including the IOUs) are generally located outside of specific areas and are therefore addressed within each watershed level discussion presented in Sections 4.3.1 – 4.3.6. The conceptual site models (CSMs) for the watershed level discussions show G-Area units and IOUs that are “to go.” Each area hazard (i.e., A Area, B Area, etc.) is presented individually beginning with Section 4.4.1 and includes the soil and groundwater hazards within the respective area. Figures in Appendix I, *Watershed Conceptual Site Models and Hazard Tables*, and Appendix J, *Area Conceptual Site Models and Hazard Tables*, are provided that

show “complete” and “to go” units visible within the extent of the figure. CSMs are provided in the area-level discussions and reflect “to go” units only.

For areas that are on geographic and/or hydrogeologic divides and influence more than one watershed, a CSM is provided for each watershed impacted by the area.

4.3.1 Upper Three Runs Watershed

Watershed Description

Upper Three Runs (UTR) originates northeast of the SRS boundary and follows a southwesterly direction for approximately 30 kilometers (km) (19 miles) within the SRS boundary and discharges directly into the Savannah River approximately 1.5 km (0.9 miles) upstream of T-Area. Within the SRS boundary, the Upper Three Runs Watershed drains approximately 250 square kilometers (km²) (97 square miles [mi²]). The entire watershed drains about 645 km² (245 mi²). The northern portion of the watershed within the site boundary includes portions of A Area, M Area, and the Savannah River National Laboratory (SRNL).

The southern portion of the Upper Three Runs Watershed includes the majority of the B-Area Administrative Center, S-Area Vitrification Facility and Z-Area Saltstone Facility, as well as portions of E-Area Waste Management Complex, F and H Separations Areas, and R-Reactor Area. The main tributaries within the SRS portion of the Upper Three Runs Watershed include Tinker Creek and Tims Branch. Smaller tributaries include Crouch Branch, McQueen Branch, and Mill Creek.

Watershed Hazards

The conceptual site model for the UTR Watershed is shown in Figure 4.1b, *Upper Three Runs CSM*, in Appendix I, *Watershed Conceptual Site Models and Hazard Tables*, and

depicts the potential sources of contamination, migration pathways, exposure media and potential receptors. Table 4.1a, *SRS End State Vision Planned by Watersheds (G-Area Only)* in Appendix I, *Watershed Conceptual Site Models and Hazard Tables*, provides a listing of the G Area hazards and facilities with associated characteristics. The major hazards in the UTR Watershed that require remediation are located in A Area, B Area, E Area, F Area, G Area (Steed Pond, UTR IOU), H Area, M Area, R Area, and S Area.

Current Watershed Cleanup Status

Table 4.1a, *SRS End State Vision Planned by Watersheds (G-Area Only)* in Appendix I, *Watershed Conceptual Site Models and Hazard Tables*, provides the current status for the G-Area hazards and the known remedial technology implemented for completed units. For hazards in the “to go” phase where the response action has not been selected, Hazard Type CSMs located in Appendix K, *Conceptual Site Models for Typical SRS Hazards (Soil, Groundwater, EM Facilities, LRW Tanks)*, provide the response actions likely to be implemented by media for each hazard type.

Table 4.2, *SRS End State Vision Hazard Type Crosswalk for Watershed “To Go” Units (G-Area Only)*, in Appendix I, *Watershed Conceptual Site Models and Hazard Tables*, depicts a crosswalk that categorizes each of the “to go” G-Area hazards and facilities in the UTR Watershed to a hazard type CSM located in Appendix K, *Conceptual Site Models for Typical SRS Hazards (Soil, Groundwater, EM Facilities, LRW Tanks)*. All remaining hazards will undergo characterization, risk analysis, and evaluation for the appropriate remedial technologies as depicted in the hazard type CSMs and Table 4.2, *SRS End State Vision Hazard Type Crosswalk for Watershed “To Go” Units (G-Area Only)*.

Twenty-seven G Area waste units were identified in the UTR Watershed of which 24 are complete. For the remaining three waste units, one is categorized as a Hazard Type 2 (Radiological Seepage Basins and Pits), one unit as Hazard Type 9 (Miscellaneous Sites), and one unit as Hazard Type 11 (Integrator Operable Units). Hazard sources to be evaluated for the remaining waste units include nonradioactive rubble and building debris, metals, organic and inorganic constituents, and radionuclides.

Planned Watershed End State

The current and projected end state for G-Area units within the UTR Watershed is to accommodate a final risk level of 10^{-4} to 10^{-6} for the industrial worker with institutional controls.

4.3.2 Fourmile Branch Watershed

Watershed Description

The Fourmile Branch (FMB) Watershed, which is located entirely within the SRS boundary, originates near the center of SRS and follows a southwesterly direction for approximately 24 km (15 mi). In the lower reaches, Fourmile Branch broadens and flows through a delta that has been formed by the deposition of sediments during reactor operations. The majority of the flow discharges into the Savannah River and a small portion of the creek flows west and enters Beaver Dam Creek. When the Savannah River floods, water from Fourmile Branch flows into the Savannah River swamp. The watershed drains about 57 km² (22 mi²) and includes several SRS facilities: C Area (C Reactor), N Area (Central Shops), F, H, and E Areas (General Separations Areas), and the Solid Waste Disposal Facility.

At its headwaters, Fourmile Branch is a small black water stream that has been relatively unimpacted by historical SRS operations. Fourmile Branch has historically and currently receives effluents from F, H, and C Areas, as

well as contaminated groundwater discharges that have migrated from SRS facilities and waste units into the stream and its tributaries.

Watershed Hazards

The conceptual site model for the FMB Watershed is shown in Figure 4.2b, *Fourmile Branch CSM*, and depicts the potential sources of contamination, migration pathways, exposure media and potential receptors. Table 4.1a, *SRS End State Vision Planned by Watersheds (G-Area Only)* in Appendix I, *Watershed Conceptual Site Models and Hazard Tables*, provides a listing of the G Area hazards and facilities with associated characteristics. The major hazards in the FMB Watersheds that require remediation are located in C Area, E Area, F Area, H Area, G Area (FMB IOU), and N Area.

Current Watershed Cleanup Status

Table 4.1a, *SRS End State Vision Planned by Watersheds (G-Area Only)* in Appendix I, *Watershed Conceptual Site Models and Hazard Tables*, also provides the current status for the G-Area hazards and the known remedial technology implemented for completed units. For hazards in the “to go” phase where the response action has not been selected, Hazard Type CSMs located in Appendix K, *Conceptual Site Models for Typical SRS Hazards (Soil, Groundwater, EM Facilities, LRW Tanks)*, provide the response actions likely to be implemented by media for each hazard type.

Table 4.2, *SRS End State Vision Hazard Type Crosswalk for Watershed “To Go” Units (G-Area Only)*, depicts a crosswalk that categorizes each of the “to go” G-Area hazards and facilities in the FMB Watershed to a Hazard Type CSM located in Appendix K, *Conceptual Site Models for Typical SRS Hazards (Soil, Groundwater, EM Facilities, LRW Tanks)*. All remaining hazards will undergo characterization, risk

analysis, and evaluation for the appropriate remedial technologies as depicted in the Hazard Type CSMs and Table 4.2, *SRS End State Vision Hazard Type Crosswalk for Watershed “To Go” Units (G-Area Only)*

Four G Area waste units were identified in the FMB Watershed of which three are complete. The remaining waste unit is categorized as Hazard Type 11 (Integrator Operable Units). Hazard sources to be evaluated for the remaining waste unit include metals, organic and inorganic constituents, and radionuclides.

Planned Watershed End State

The current and projected end state for G-Area units within the FMB Watershed is to accommodate a final risk level of 10^{-4} to 10^{-6} for the industrial worker with institutional controls.

4.3.3 Pen Branch Watershed

Watershed Description

The Pen Branch (PB) Watershed originates near the center of SRS and follows in a southwesterly direction for approximately 18 km (11 mi) discharging into the Savannah River floodplain swamp rather than flowing directly into the Savannah River. The PB Watershed is located entirely on SRS property. Pen Branch flows southwesterly from its headwaters, about 3.2 km (2 mi) east of K-Area, to the Savannah River swamp. After entering the swamp, PB flows parallel to the Savannah River for about 8 km (5 mi) before it enters and mixes with the water of Steel Creek about 0.4 km (0.2 mi) from the mouth of Steel Creek at the Savannah River. The PB Watershed drains about 56 km² (21 mi²) and includes the entirety of K Area (K Reactor) and portions of N Area (Central Shops) and waste units associated with L Area (L Reactor). Indian Grave Branch is the principal tributary of Pen Branch.

Watershed Hazards

The conceptual site model for the PB Watershed is shown in Figure 4.3b, *Pen Branch CSM* in Appendix I, *Watershed Conceptual Site Models and Hazard Tables*, and depicts the potential sources of contamination, migration pathways, exposure media and potential receptors. Table 4.1a, *SRS End State Vision Planned by Watersheds (G-Area Only)*, provides a listing of the G Area hazards and facilities with associated characteristics. The major hazards in the PB Watershed that require remediation are located in G Area (CMP Pits, PB IOU), K Area, L Area, and N Area.

Current Watershed Cleanup Status

Table 4.1a, *SRS End State Vision Planned by Watersheds (G-Area Only)*, in Appendix I, *Watershed Conceptual Site Models and Hazard Tables*, provides the current status for the G-Area hazards and the known remedial technology implemented for completed units. For hazards in the “to go” phase where the response action has not been selected, Hazard Type CSMs located in Appendix K, *Conceptual Site Models for Typical SRS Hazards (Soil, Groundwater, EM Facilities, LRW Tanks)*, provide the response actions likely to be implemented by media for each hazard type.

Table 4.2, *SRS End State Vision Hazard Type Crosswalk for Watershed “To Go” Units (G-Area Only)* in Appendix I, *Watershed Conceptual Site Models and Hazard Tables*, depicts a crosswalk that categorizes each of the “to go” G-Area hazards and facilities in the PB Watershed to a Hazard Type CSM located in Appendix K, *Conceptual Site Models for Typical SRS Hazards (Soil, Groundwater, EM Facilities, LRW Tanks)*. All remaining hazards will undergo characterization, risk analysis, and evaluation for the appropriate remedial technologies as depicted in the hazard type CSMs and Table 4.2, *SRS End State Vision*

Hazard Type Crosswalk for Watershed “To Go” Units (G-Area Only).

Ten G Area waste units were identified in the PB Watershed of which two are complete. From the remaining eight waste units, seven units are categorized as Hazard Type 5 (Nonradiological Rubble Piles and Pits) and one unit is categorized as Hazard Type 11 (Integrator Operable Units). Hazard sources to be evaluated for the remaining waste units include nonradioactive rubble and building debris, metals, organic and inorganic constituents, and radionuclides.

Planned Watershed End State

The current and projected end state for G-Area units within the PB Watershed is to accommodate a final risk level of 10^{-4} to 10^{-6} for the industrial worker with institutional controls.

4.3.4 Steel Creek Watershed

Watershed Description

The headwaters of Steel Creek (SC) originate near P-Reactor, southwest of Par Pond. SC flows southwesterly about 3 km (1.8 mi) before it enters the headwater of L Lake. L Lake is 6.5 km (4.0 mi) long with an area of about 1034 acres. Flow from the outfall of L Lake dam travels about 5 km (3 mi) before entering the Savannah River swamp and another 3 km (1.8 mi) before entering the Savannah River. SC has received thermal discharges and increased flow from reactor operations that produced an extensive delta where SC enters the Savannah River floodplain swamp. Meyers Branch, the main tributary of SC, flows approximately 10 km (6.2 mi) before entering SC. Meyers Branch is relatively undisturbed by SRS operations. The total area drained by the Steel Creek and Meyers Branch system is about 91 km² (35 mi²) and includes portions of P and L Areas.

Watershed Hazards

The conceptual site model for the SC Watershed is shown in Figure 4.4b, *Steel Creek CSM* in Appendix I, *Watershed Conceptual Site Models and Hazard Tables*, and depicts the potential sources of contamination, migration pathways, exposure media and potential receptors. Table 4.1a, *SRS End State Vision Planned by Watersheds (G-Area Only)* in Appendix I, *Watershed Conceptual Site Models and Hazard Tables*, provides a listing of the G Area hazards and facilities with associated characteristics. The major hazards in the SC Watershed that require remediation are located in G Area (L Lake, SC IOU), P Area, and L Area.

Current Watershed Cleanup Status

Table 4.1a, *SRS End State Vision Planned by Watersheds (G-Area Only)* in Appendix I, *Watershed Conceptual Site Models and Hazard Tables*, provides the current status for the G-Area hazards and the known remedial technology implemented for completed units. For hazards in the “to go” phase where the response action has not been selected, Hazard Type CSMs located in Appendix K, *Conceptual Site Models for Typical SRS Hazards (Soil, Groundwater, EM Facilities, LRW Tanks)*, provide the response actions likely to be implemented by media for each hazard type.

Table 4.2, *SRS End State Vision Hazard Type Crosswalk for Watershed “To Go” Units (G-Area Only)* in Appendix I, *Watershed Conceptual Site Models and Hazard Tables*, depicts a crosswalk that categorizes each of the “to go” G-Area hazards and facilities in the SC Watershed to a hazard type CSM located in Appendix K, *Conceptual Site Models for Typical SRS Hazards (Soil, Groundwater, EM Facilities, LRW Tanks)*. All remaining hazards will undergo characterization, risk analysis, and evaluation for the appropriate remedial technologies as depicted in the Hazard Type

CSMs and Table 4.2, *SRS End State Vision Hazard Type Crosswalk for Watershed “To Go” Units (G-Area Only)*, also in Appendix I, *Watershed Conceptual Site Models and Hazard Tables*.

Nine G Area waste units were identified in the SC Watershed of which six are complete. From the remaining three waste units, one unit is categorized as Hazard Type 5 (Nonradiological Rubble Piles and Pits), one unit is categorized as Hazard Type 9 (Miscellaneous Sites), and one unit is categorized as Hazard Type 11 (Integrator Operable Units). Hazard sources to be evaluated for the remaining waste units include nonradioactive rubble and building debris, metals, organic and inorganic constituents, and radionuclides.

Planned Watershed End State

The current and projected end state for G-Area units within the SC Watershed is to accommodate a final risk level of 10^{-4} to 10^{-6} for the industrial worker with institutional controls.

4.3.5 Lower Three Runs Watershed

Watershed Description

The Lower Three Runs (LTR) Watershed is located on the eastern portion of SRS and lies partially within the SRS boundary. The LTR stream is the principle surface water body within the watershed and is located entirely on SRS property, including the narrow corridor that extends from Patterson Mill to the confluence with the Savannah River. The watershed, which drains about 460 km² (178 mi²), includes the R-Reactor Area, a portion of P-Reactor-Area, ecological laboratories and various Soils and Groundwater Project waste sites. Industrial facilities located outside the eastern SRS boundary are also located within the LTR Watershed. A mainstream impoundment, Par Pond, was constructed along with several other

retaining ponds on the headwaters of LTR to receive reactor effluent.

Watershed Hazards

The conceptual site model for the LTR Watershed is shown in Figure 4.5b, *Lower Three Runs CSM* in Appendix I, *Watershed Conceptual Site Models and Hazard Tables*, and depicts the potential sources of contamination, migration pathways, exposure media and potential receptors. Table 4.1a, *SRS End State Vision Planned by Watersheds (G-Area Only)* in Appendix I, *Watershed Conceptual Site Models and Hazard Tables*, provides a listing of the G Area hazards and facilities with associated characteristics. The major hazards in the LTR Watershed that require remediation are located in G Area (LTR IOU, Par Pond), R Area, and P Area.

Current Watershed Cleanup Status

Table 4.1a, *SRS End State Vision Planned by Watersheds (G-Area Only)*, provides the current status for the G-Area hazards and the known remedial technology implemented for completed units. For hazards in the “to go” phase where the response action has not been selected, Hazard Type CSMs located in Appendix K, *Conceptual Site Models for Typical SRS Hazards (Soil, Groundwater, EM Facilities, LRW Tanks)*, provide the response actions likely to be implemented by media for each hazard type.

Table 4.2, *SRS End State Vision Hazard Type Crosswalk for Watershed “To Go” Units (G-Area Only)* in Appendix I, *Watershed Conceptual Site Models and Hazard Tables*, depicts a crosswalk that categorizes each of the “to go” G-Area hazards and facilities in the LTR Watershed to a Hazard Type CSM located in Appendix K, *Conceptual Site Models for Typical SRS Hazards (Soil, Groundwater, EM Facilities, LRW Tanks)*. All remaining hazards will undergo characterization, risk analysis, and

evaluation for the appropriate remedial technologies as depicted in the hazard type CSMs and Table 4.2, *SRS End State Vision Hazard Type Crosswalk for Watershed “To Go” Units (G-Area Only)*.

Twelve G Area facilities were identified in the LTR Watershed of which five are complete. From the remaining seven waste units, four units are categorized as Hazard Type 5 (Nonradiological Rubble Piles and Pits), one unit as Hazard Type 7 (Sludge Application Sites), one unit as Hazard Type 9 (Miscellaneous Sites), and one unit as Hazard Type 11 (Integrator Operable Units). Hazard sources to be evaluated for the remaining waste units include nonradioactive rubble and building debris, metals, organic and inorganic constituents, and radionuclides.

Planned Watershed End State

The current and projected end state for G-Area units within the LTR Watershed is to accommodate a final risk level of 10^{-4} to 10^{-6} for the industrial worker with institutional controls.

4.3.6 Savannah River / Floodplain / Swamp Watershed

Watershed Description

The Savannah River (SR) Watershed drains about 27,388 km² (10,574 mi²) and includes western South Carolina, eastern Georgia, and a small portion of southwestern North Carolina. Approximately 31% or 8631 km² of the watershed area is located in the Coastal Plain that includes Augusta (Georgia), SRS, and the city of Savannah to the Atlantic Ocean. The Savannah River and Floodplain Swamp IOU includes the 100-year floodplain (including the Savannah River swamp) and any continuous wetlands including the Savannah River adjacent and down gradient of the SRS. This area encompasses approximately 72 km (45 mi) from the northern boundary of SRS above Upper

Three Runs southward to the US. Highway 301 Bridge. The five major SRS streams feed into the Savannah River and floodplain swamp (Upper Three Runs, Fourmile Branch, Pen Branch, Steel Creek, and Lower Three Runs.) The Savannah River and Floodplain Swamp Watershed includes portions of A/M-Area, D-Area, and TNX.

Watershed Hazards

The conceptual site model for the SR Watershed is shown in Figure 4.6b, *Savannah River/Floodplain CSM* in Appendix I, *Watershed Conceptual Site Models and Hazard Tables*, and depicts the potential sources of contamination, migration pathways, exposure media and potential receptors. Table 4.1a, *SRS End State Vision Planned by Watersheds (G-Area Only)* in Appendix I, *Watershed Conceptual Site Models and Hazard Tables*, provides a listing of the G Area hazards and facilities with associated characteristics. The major hazards in the SR Watershed that require remediation are located in A/M-Area, D-Area, and TNX. There are no G-Area “to go” units with the exception of the Savannah River / Floodplain / Swamp IOU.

Current Watershed Cleanup Status

Table 4.1a, *SRS End State Vision Planned by Watersheds (G-Area Only)*, provides the current status for the G-Area hazards and the known remedial technology implemented for completed units. For hazards in the “to go” phase where the response action has not been selected, Hazard Type CSMs located in Appendix I, *Watershed Conceptual Site Models and Hazard Tables*, provide the response actions likely to be implemented by media for each hazard type.

Table 4.2, *SRS End State Vision Hazard Type Crosswalk for Watershed “To Go” Units (G-Area Only)* in Appendix I, *Watershed Conceptual Site Models and Hazard Tables*,

depicts a crosswalk that categorizes each of the “to go” G-Area hazards and facilities in the SR Watershed to a hazard type CSM located in Appendix K, *Conceptual Site Models for Typical SRS Hazards (Soil, Groundwater, EM Facilities, LRW Tanks)*. All remaining hazards will undergo characterization, risk analysis, and evaluation for the appropriate remedial technologies as depicted in the hazard type CSMs and Table 4.2, *SRS End State Vision Hazard Type Crosswalk for Watershed “To Go” Units (G-Area Only)*.

Eight G Area waste units were identified in the SR Watershed of which seven are complete. The remaining waste unit is categorized as Hazard Type 11 (Integrator Operable Units). Hazard sources to be evaluated for the remaining waste unit include metals, organic and inorganic constituents, and radionuclides.

Planned Watershed End State

The current and projected end state for G-Area units within the SR Watershed is to accommodate a final risk level of 10^{-4} to 10^{-6} for the industrial worker with institutional controls.

4.4 Hazard-Specific Discussion by Areas

Note: Area Totals for EM Facilities (Area D&D Tables) below— “Current Status Complete” is representative of facility decommissioning completions as of the March 30, 2004.

4.4.1 A Area

Area Description

A Area is located in the northwest part of SRS and is approximately 1,050 m (3,500 ft) from the plant boundary and covers approximately 400 acres (1.6 km²). A-Area waste units are located in the Upper Three Runs and Savannah River/Floodplain Swamp Watersheds. Facilities and activities have a relatively low potential for

offsite release of hazardous materials. The current designated land use for A Area is administrative and industrial.

Mission Description

A Area is primarily comprised of administrative, laboratory, industrial support, and some warehouse facilities. This part of the site functions as the primary entry point for visitors to the site. Most facilities were constructed in the early 1950s and many continue to provide adequate accommodations for their intended missions. However others presently require investment in maintenance and repair while still others are slated for deactivation and decommissioning.

The Savannah River National Laboratory (SRNL) is a major tenant in A Area. As part of research and development, it is likely that small quantities of the constituents used in site processes were used at SRNL at some time. Originally established to support the production of nuclear materials for national defense, SRNL plays a key role in advancing science and technology developments for defense applications. As a national center for technological innovations, SRNL facilities continue to support the national interest by providing the laboratory setting for technology advancements in waste vitrification, environmental remediation, robotics, and advanced sensor systems. SRNL laboratory buildings, constructed in 1953, have been effectively maintained throughout the history of SRNL. Modest infrastructure investments have been made recently to these buildings and have prepared them to support SRNL's current and future missions. However, the SRNL infrastructure is in relatively good shape and is prepared to support the enduring nature of the SRNL. SRNL provides critical nuclear research and support to the tritium, plutonium, and legacy wastes missions. For this reason, heightened security is provided for this facility.

Another major A-Area tenant is the Savannah River Ecology Laboratory (SREL), operated by the University of Georgia. Since 1951, SREL has conducted independent ecological research at SRS, which includes research on land and water use, land and water management, and the impact of SRS operation practices on the environment. A permanent ecology laboratory was established in 1961, and new laboratories and a new computer center were added in the 1990s. In addition to the laboratory, SREL operates three greenhouses, an animal care facility, an aquatic animal care facility, an avian housing facility, a distance learning facility, a series of small ponds, and various storage and maintenance buildings.

A Area is also the location of several critical 24-hour operations, including the Emergency Operations Center, SRNL Laboratory Operations, Records Storage, SRS Fire Department, and the Central Unclassified and Classified Computer Facilities.

Area Hazards

The conceptual site models for A-Area are provided in Figures 4.7b.1, *A-Area CSM for Upper Three Runs*, and 4.7b.2, *A-Area CSM for the Savannah River/Floodplain Swamp Watershed*, both located in Appendix J, *Area Conceptual Site Models and Hazard Tables*. These depict the potential sources of contamination, migration pathways, exposure media and potential receptors. Table 4.3a, *Alternative Planned End State by Areas*, located in Appendix J, *Area Conceptual Site Models and Hazard Tables*, provides a listing of the A-Area waste units with associated characteristics. With the exception of G-Area waste units previously discussed with the appropriate watershed, the major hazards in A Area that require further evaluation and potential remediation are the SRL 904-A Process Trench, A-001 Outfall, A-Area Miscellaneous Rubble Pile, and the Miscellaneous Chemical Basin.

Area Cleanup Status

Table 4.3a, *SRS End State Vision Planned by Area*, provides the current remedial status for the A-Area waste units and the remedial technology implemented for completed units. For waste units in the “to go” phase where the response action has not been selected, Table 4.4a, *SRS End State Vision Hazard Type Crosswalk for Area ‘To Go’ Units* in Appendix J, *Area Conceptual Site Models and Hazard Tables*, depicts a crosswalk that categorizes each of the “to go” units to a hazard type CSM located in Appendix K, *Conceptual Site Models for Typical Hazards (Soil, Groundwater, EM Facilities, LRW Tanks)*. The hazard type CSMs list the remedial technologies likely to be implemented for each hazard type. The “to go” waste units will undergo characterization, risk analysis, and evaluation for the appropriate remedial technologies.

Remediation for 14 of the 31 A-Area waste units is complete (Table 4.3a, *SRS End State Vision Planned by Area*). For the remaining 17 “to go” waste units, seven units are categorized as Hazard Type 9 (Miscellaneous Sites), six as Hazard Type 5 (Nonradiological Rubble Piles and Pits), three as Hazard Type 3 (Coal Pile Runoff Basins and Ash Basins), and one as Hazard Type 6 (Nonradiological Seepage Basins). Hazard sources to be evaluated for the remaining A-Area waste units include a variety of radioactive releases, nonradioactive rubble and building debris, organic and inorganic constituents.

Area Planned End State Hazards

The current and projected end state for A-Area waste units is to accommodate a final risk level of 10^{-4} to 10^{-6} with institutional controls for the industrial worker and below MCLs for groundwater.

Mission and Facility End State

The primary focus for facility end state in A Area includes a significant shutdown of A Area activities to shrink the infrastructure maintenance and operation requirements and consolidate and strengthen secure areas. Additional studies and characterization are needed to determine the level of shut down of A Area facilities before final decisions are made. These studies are needed once DOE decisions on future missions for SRS are made. Any additional consolidation of administrative areas would be located closer to the center of the site.

Essential infrastructure elements of SRNL technical area facilities will be maintained operable through 2025 to serve EM and National NNSA needs. The need by enduring DOE Programs for new, centralized facilities or a reduced footprint version of the current facilities would be assessed at that time. New missions are expected to provide any required, incremental research and development infrastructure. Any new SRNL facility would most likely be located in the central industrialized area of the site.

Site warehouse operations in A Area would not be necessary if the administrative and laboratory functions were relocated. Warehouse and maintenance operations in A Area could be consolidated in N Area. After the majority of employees have relocated to the center of the site, the steam requirements would be lessened, and use of the A-Area Powerhouse could be phased out.

EM plans on transitioning Savannah River Ecology Laboratory to a new Cognizant Secretarial Office (CSO) that is better aligned with the evolving SREL mission.

The SRS Cleanup Reform Vision is to demolish EM buildings and structures located in A Area by 2025. The only exceptions will be evaluated

per the *Savannah River Site's Cold War Built Environment Cultural Resources Management Plan* (CRMP) to determine their historic preservation use, as well as an evaluation for the local economic outreach initiative. Building 742-A may be designated as the SRS Heritage Center. The following buildings have potential for continued use through the local economic outreach initiative: 703-43A, 703-45A, 703-47A, 707-A, 717-10A, 721-12A, 724-16A, 733-1A, 740-1A, 740-8A, 743-1A, 745-A, 754-8A, and 763-A.

Below is a table showing the number of nuclear, radiological and industrial facilities in A Area. End states are shown as either demolished or in situ. This information is based on the *SRS EM D&D Plan*, which did not account for reuse by other federal facilities or economic development or for historic preservation. D&D has been initiated on many administrative and industrial facilities in A Area as these functions are moved to the central core area of the site.

A Area Totals			End State	
Facility Haz Type	No.	Sq Ft	Dem	ISD
Nuc	8	325,544	8	0
Rad	0	0	0	0
Oth Ind	139	1,342,353	139	0
Total	147	1,667,897	147	0

Nuc- Nuclear

Rad – Radiological

Oth Ind – Other Industrial

No. – Number of facilities

Sq Ft – Square Feet

Comp – Complete

Dem – Demolished

ISD – In situ disposal

Table 4.3 A-Area D&D Table

NOTE: Information provided in this table is based on the *DOE/WSRC Contract No. DE-AC09-96R18500, Modification Number 100*, and the *Savannah River Site Environmental Management Integrated Deactivation and Decommissioning Plan*, Rev. 1, September 30, 2003. Current status is shown facilities completed as of the end of fiscal year 2003 (September 30, 2003).

4.4.2 B Area

Area Description

B Area is located approximately four miles from A Area, near the intersection of Road C and Road 2. It is comprised primarily of administrative, protective force operations, laboratory, and warehouse facilities. All B-Area waste units are located in the Upper Three Runs Watershed with the exception of one rubble pile located in the Savannah River/Floodplain Swamp Watershed.

Some B-Area facilities were constructed in the early 1950s and new administrative buildings were added in the 1990s. Modern administrative, laboratory and engineering facilities were recently constructed for information technology, environmental sciences, safety and health, project engineering and construction, and procurement personnel. The current land use designation for B Area is site industrial.

Mission Description

Many of the administrative staffs are currently located in B Area, including the DOE-SR Manager. Another major tenant in B Area is Wackenhut Services, Incorporated – Savannah River Site (WSI-SRS), which provides protective-force personnel to guard DOE security interests. SREL currently operates laboratories in B Area, adjacent to WSI-SRS.

Bordering B Area, in an area formerly called U Area, is the location of the former Heavy Water

Components Test Reactor (HWCTR). The facility was a research and development reactor built in the 1960s and operated for only a few years. It was shut down permanently in 1967. The support buildings and structures have been demolished, and the only structure remaining is the reactor building. This building is a high-integrity steel containment structure that has been deactivated and welded shut, placing the facility into long-term safe storage.

Area Hazards

Although B Area is influenced by a topographic and hydrogeologic divide, only one conceptual site model is provided in Figures 4.8b, *B-Area CSM for Upper Three Runs Watershed* in Appendix I, *Watershed Conceptual Site Models and Hazard Tables*, depicting the potential sources of contamination, migration pathways, exposure media and potential receptors. There is one completed (no action) waste unit that resides in the Savannah River/Floodplain Swamp Watershed. Table 4.3.a, *SRS End State Vision Planned by Area* in Appendix J, *Area Conceptual Site Models and Hazard Tables*, provides a listing of the B-Area waste units with associated characteristics. G-Area waste units were discussed previously with the appropriate watershed. There are no major hazards in B Area that require remediation.

Area Cleanup Status

Table 4.3a, *SRS End State Vision Planned by Area*, provides the current remedial status for the B-Area waste units and the remedial technology implemented for completed units. For waste units in the “to go” phase where the response action has not been selected, Table 4.4a, *SRS End State Vision Hazard Type Crosswalk for Area ‘To Go’ Units*, depicts a crosswalk that categorizes each of the “to go” units” to a hazard type CSM located in Appendix K, *Conceptual Site Models for Typical SRS Hazards (Soil, Groundwater, EM Facilities, LRW Tanks)*. The

hazard type CSMs list the remedial technologies likely to be implemented for each hazard type. The “to go” waste units will undergo characterization, risk analysis, and evaluation for the appropriate remedial technologies.

Remediation for 14 of the 17 B-Area waste units is complete (see Table 4.3). For the remaining three “to go” waste units, two units are categorized as Hazard Type 5 (Nonradiological Rubble Piles and Pits) and one unit as Hazard Type 9 (Miscellaneous Sites). Hazard sources to be evaluated for the remaining B-Area waste units include nonradioactive rubble and building debris, organic and inorganic constituents.

Area Planned End State Hazards

The current and projected end state for B-Area waste units is to accommodate a final risk level of 10^{-4} to 10^{-6} with institutional controls for the industrial worker.

Mission and Facility End State

Plans are for B Area to become a centralized site administrative complex. DOE-SR and WSRC administrative functions formerly located in A Area have been relocated to B Area, as new office space is made available to consolidate site administrative employees. A facility or facilities to accommodate site visitors and provide badging will also be constructed in B Area. This facility will be located outside of the secure area, and a security gatehouse will be located near to the B-Area functions to control public access to the site operations.

A new training facility may be constructed in B Area to move this administrative function out of the Heavy Industrial Zone. Locating the training function outside of the nuclear industrial area and closer to site boundaries would facilitate evacuation in the event of an emergency incident. This would also be a cost savings as a B-Area location would put the majority of site employees closer to the training facility. Support

operations, such as fire protection and record storage, also will need to be constructed.

As the USDA United States Forest Service - Savannah River (USFS-SR) and SREL facilities near the end of their useful life, USFS-SR administrative and educational program functions and SREL administrative offices will be located in B Area. The USFS-SR will also maintain strategically placed fire protection equipment, engineering, and maintenance materials and equipment in B Area and elsewhere around the site. SREL administration will be located outside the secure area near the visitor's center and SREL will maintain laboratory and environmental monitoring facilities around the site, as needed.

In the absence of continuing mission area assignments, all facilities in B Area may be demolished by 2025, subject to an evaluation per the CRMP for historic preservation and the local economic outreach initiative.

Below is a table showing the number of nuclear, radiological and industrial facilities in B Area. End states are shown as either demolished or in situ. This information is based on the *SRS EM D&D Plan*, which did not account for reuse by other federal facilities or economic development or for historic preservation.

B Area is the portion of the central core area of the site that has received most of the administrative functions transitioned out of A Area. Significant D&D activities have not begun in B Area .

B and U Areas Totals			End State	
Facility Haz Type	No.	Sq Ft	DEM	ISD
Nuc	0	0	0	0
Rad	0	0	0	0
Oth Ind	31	618,343	30	1
Total	31	618,343	30	1

Table 4.4 B-Area D&D Table

NOTE: Information provided in this table is based on the *DOE/WSRC Contract No. DE-AC09-96R18500, Modification Number 100*, and *the Savannah River Site Environmental Management Integrated Deactivation and Decommissioning Plan*, Rev. 1, September 30, 2003. Current status is shown facilities completed as of the end of fiscal year 2003 (September 30, 2003).

4.4.3 C Area

Area Description

C Area is comprised of nuclear industrial, light machining and administrative facilities. All C-Area waste units are located in the Fourmile Branch Watershed. The current land use for C Area is site industrial.

Mission Description

C Area is one of five SRS reactor areas with the original mission of producing material for the Department of Defense nuclear weapons program. The C-Area Reactor at SRS is inactive, and the reactor building is being used as a Decontamination Center. Most facilities were originally constructed in the early 1950s and continue to provide adequate accommodations for their current missions.

C Reactor is a multiple-story facility that contained a heavy water moderated production reactor. The C Reactor Assembly Area, formerly used for the receipt, handling, and storage of new, unirradiated fuel and targets

from the M-Area manufacturing area, currently houses the Site Decontamination Center. The disassembly area consists primarily of a water-filled basin with metal racks designed for vertical storage of fuel tubes and metal buckets for storing targets during operations. The basin contains several million gallons of water and in the past it allowed the target and fuel assemblies to undergo natural radioactive decay after neutron irradiation, usually over a period of 12 to 18 months. Currently, no irradiated or unirradiated fuel or targets are stored in the 105-C Disassembly Basin or Assembly Area. The ground level of C Reactor has been modified to serve as a central decontamination facility for radiologically contaminated operations and maintenance equipment. However, heavy water continues to be stored in the reactor building in the designated process tanks.

Area Hazards

The conceptual site model for C Area is provided in Figure 4.9b, *C-Area CSM for Fourmile Branch Watershed* in Appendix J, *Area Conceptual Site Models and Hazard Table*, and depicts the potential sources of contamination, migration pathways, exposure media and potential receptors. Table 4.3a, *SRS End State Vision Planned by Area*, provides a listing of the C-Area waste units with associated characteristics. With the exception of G-Area waste units previously discussed with the appropriate watershed, the major hazards in C Area that require further evaluation and potential remediation are the C-Area Disassembly Basin, C-Area Reactor Discharge Canal, Inactive Process Sewer Lines, C Reactor Area Cask Car Railroad Tracks, and C-Area Reactor Groundwater.

Area Cleanup Status

Table 4.3a, *SRS End State Vision Planned by Area*, also provides the current remedial status for the C-Area waste units and the remedial

technology implemented for completed units. For waste units in the “to go” phase where the response action has not been selected, Table 4.4a, *SRS End State Vision Hazard Type Crosswalk for Area “To Go” Units*, depicts a crosswalk that categorizes each of the “to go” units” to a hazard type CSM located in Appendix K, *Conceptual Site Models for Typical SRS Hazards (Soil, Groundwater, EM Facilities, LRW Tanks)*. The hazard type CSMs list the remedial technologies likely to be implemented for each hazard type. The “to go” waste units will undergo characterization, risk analysis, and evaluation for the appropriate remedial technologies.

Remediation for 20 of the 31 C-Area waste units is complete (see Table 4.3). For the remaining 11 “to go” waste units, two units are categorized as Hazard Type 2 (Radiological Seepage Basins and Pits), two units as Hazard Type 3 (Coal Pile Runoff Basins and Ash Basins), one unit as Hazard Type 4 (Inactive Process Sewer Lines), four units as Hazard Type 5 (Nonradiological Rubble Piles and Pits), one unit as Hazard Type 9 (Miscellaneous Sites), and one unit as Hazard Type 10 (Groundwater). Hazard sources to be evaluated for the remaining C-Area waste units include radionuclides, nonradioactive rubble and building debris, organic and inorganic constituents.

Remedial technologies for groundwater are presented with each Hazard Type CSM in Appendix K, *Conceptual Site Models for Typical SRS Hazards (Soil, Groundwater, EM Facilities, and LRW Tanks)*. C-Area Groundwater is the only C-Area groundwater waste unit in the “to go” phase. The groundwater pathways with impacted media and receptors are shown on Figure 4.9b, *C-Area CSM for Fourmile Branch Watershed*. A tritium plume, a TCE plume and a PCE plume were identified in C Area. Sources of the contamination have been identified within the C Reactor area perimeter fence. Tritium is related to the operation of the reactor itself and

was released from numerous sources and spills. Characterization data indicates the tritium source is depleted. A TCE source was discovered near the assembly building and appears to be the source of the reactor TCE plume. The TCE source is considered to be a continuing source because of the residuals in the soil. In addition, tritium has been detected above MCLs in Fourmile Branch and its tributaries Caster Creek and Twin Lakes.

Area Planned End State Hazards

The current and projected end state for C-Area waste units is to accommodate a final risk level of 10^{-4} to 10^{-6} with institutional controls for the industrial worker and below MCLs for groundwater.

Mission and Facility End State

The reactor building, 105-C, once its decontamination mission is complete, may be saved for Cold War Historic Preservation. In addition, other reactor support buildings (106-C, 107-C, 108-1C, 108-2C, 109-C, 151-1C, 151-2C, 701-1C, 704-C, 706-C, 186-C, and 190-C) may also be preserved for historic preservation. All other hardened buildings may be demolished after being evaluated per the CRMP to determine their historic preservation status, as well as an evaluation for the local economic outreach initiative.

All non-hardened support buildings and administrative buildings may have been demolished. All temporary buildings and trailers would have been removed. The Disassembly Basin would have been decommissioned with an environmental cap installed. A fence around the perimeter any remaining facilities will secure the 105-C Complex.

Below is a table showing the number of nuclear, radiological and industrial facilities in C Area. End states are shown as either demolished or in situ. This information is based on the *SRS EM*

D&D Plan, which did not account for reuse by other federal facilities or economic development or for historic preservation.

D&D has been initiated on a limited number of industrial facilities in C Area. Action on the major reactor facility and reactor support facilities has been deferred to allow further evaluation of their suitability as a historic site.

C Area Totals			End State	
Facility Haz Type	No.	Sq Ft	DEM	ISD
Nuc	1	385,010	0	1
Rad	0	0	0	0
Oth Ind	24	389,915	17	7
Total	25	774,925	17	8

Table 4.5 C-Area D&D Table

NOTE: Information provided in this table is based on the *DOE/WSRC Contract No. DE-AC09-96R18500, Modification Number 100*, and the *Savannah River Site Environmental Management Integrated Deactivation and Decommissioning Plan, Rev. 1, September 30, 2003*. Current status is shown facilities completed as of the end of fiscal year 2003 (September 30, 2003).

4.4.4 D Area

Area Description

D Area is located 1.4 km (0.9 mi) east of the Savannah River on an upland terrace between Upper Three Runs to the north and Fourmile Branch to the south. The site is at an elevation of 42.7 m (140 ft) above mean sea level. D-Area waste units are located in the Savannah River/Floodplain Swamp Watershed. The current land use for D Area is site industrial.

Mission Description

D-Area Heavy Water Facilities provided the heavy water necessary to moderate SRS's five nuclear reactors. D Area originally contained three sets of heavy water extraction towers with the support facilities needed to concentrate sufficient heavy water using the Savannah River as the water source. These original towers were operational until 1982. Since then, all three sets of extraction towers have been demolished with only the foundations remaining. The remaining heavy water rework facilities were shut down in 1998 and deactivated the following year. Facilities currently operating in D Area include a coal-fired power plant (leased by SRS to the South Carolina Electric and Gas Company [SCE&G]). Some non-power plant administrative and support facilities are being used in the short term but will soon become inactive (under surveillance and maintenance) and are scheduled for deactivation and decommissioning.

Area Hazards

The conceptual site model for D Area is provided in Figure 4.10b, *D Area CSM for Savannah River/Floodplain Swamp Watershed* in Appendix J, *Area Conceptual Site Models and Hazard Tables*, and depicts the potential sources of contamination, migration pathways, exposure media and potential receptors. *Table 4.3a, SRS End State Vision Planned by Area* in Appendix J, *Area Conceptual Site Models and Hazard Tables*, provides a listing of the D-Area waste units with associated characteristics. With the exception of G-Area waste units previously discussed with the appropriate watershed, the major hazards in D Area that require further evaluation and potential remediation are the 488-1D, 488-2D, and 488-4D Ash Basins and the D Area Groundwater Operable Unit.

Area Cleanup Status

Table 4.3a, *Alternative Planned End State by Areas*, provides the current remedial status for the D-Area waste units and the remedial technology implemented for completed units. For waste units in the "to go" phase where the response action has not been selected, *Table 4.4a, SRS End State Vision Hazard Type Crosswalk for Area 'To Go' Units*, depicts a crosswalk that categorizes each of the "to go" units" to a hazard type CSM located in Appendix K *Conceptual Site Models for Typical SRS Hazards (Soil, Groundwater, EM Facilities, LRW Tanks)*

The hazard type CSMs list the remedial technologies likely to be implemented for each hazard type. The "to go" waste units will undergo characterization, risk analysis, and evaluation for the appropriate remedial technologies.

Remediation for 15 of the 26 D-Area waste units is complete (Table 4.3). For the remaining 11 "to go" waste units, five units are categorized as Hazard Type 3 (Coal Pile Runoff Basins and Ash Basins), three units as Hazard Type 5 (Nonradiological Rubble Piles and Pits), three units as Hazard Type 9 (Miscellaneous Sites), and two unit as Hazard Type 10 (Groundwater). Hazard sources to be evaluated for the remaining D-Area waste units include nonradioactive rubble and building debris, organic and inorganic constituents.

Remedial technologies for groundwater are presented with each Hazard Type CSM in Appendix K, *Conceptual Site Models for Typical SRS Hazards (Soil, Groundwater, EM Facilities, and LRW Tanks)*. D-Area Groundwater Operable Unit is the only D-Area groundwater waste unit in the "to go" phase. The groundwater pathways with impacted media and receptors are shown on Figure 4.10b, *D-Area CSM for Savannah River/Floodplain Swamp Watershed*.

Low concentration and commingled tritium, TCE and inorganic plumes were identified in D Area. The TCE and tritium sources are thought to be depleted in the vadose zone. The inorganic plume sources have been identified and are, or will be, addressed. D-Area groundwater with contaminants above MCLs has the potential to impact the Savannah River Swamp and Savannah River. The groundwater investigation is entering the next phase to define the extent of the contaminant plumes.

Area Planned End State Hazards

The current and projected end state for D-Area waste units is to accommodate a final risk level of 10^{-4} to 10^{-6} with institutional controls for the industrial worker and below MCLs for groundwater.

Mission and Facility End State

The extraction towers have been demolished and every building and structure is scheduled for demolition including the coal-fired generating station, subject to evaluation per the CRMP for historic preservation and the local economic outreach initiative.

Below is a table showing the number of nuclear, radiological and industrial facilities in D Area. End states are shown as either demolished or in situ. This information is based on the *SRS EM D&D Plan*, which did not account for reuse by other federal facilities or economic development or for historic preservation.

D&D has been initiated on the majority of the facilities in D Area with the exception of the D Area Power House that will continue to provide power and steam to the site.

D Area Totals			End State	
Facility Haz Type	No.	Sq Ft	DEM	ISD
Nuc	0	0	0	0
Rad	2	14,867	2	0
Oth Ind	42	219,417	41	1
Total	44	234,284	43	1

Table 4.6 D-Area D&D Table

NOTE: Information provided in this table is based on the *DOE/WSRC Contract No. DE-AC09-96R18500, Modification Number 100*, and *the Savannah River Site Environmental Management Integrated Deactivation and Decommissioning Plan, Rev. 1, September 30, 2003*. Current status is shown facilities completed as of the end of fiscal year 2003 (September 30, 2003).

4.4.5 E Area

Area Description

E Area is located in the central part of SRS between the F and H-Area Separations Areas and is approximately 9.7 km (6 mi) from the plant boundary and covers approximately 330 acres. The current land use for E Area is site industrial.

Mission Description

E Area, which includes the Old Burial Ground, Mixed Waste Management Facility, TRU waste pads, and E-Area Vaults, receives low-level solid, TRU, and mixed waste from all site areas. E-Area facilities are maintained to manage previously received waste and to prepare for the receipt of waste from new site operations. Low-level waste is disposed in the E-Area Vaults or trenches. Transuranic (TRU) waste is characterized and made ready for shipment to the Waste Isolation Pilot Plant (WIPP) for ultimate disposal. The total inventory of TRU

waste in storage is currently over 8,000 cubic meters. This waste, some of which has been in storage since 1974, is contained in numerous packaging configurations including 55- and 83-gallon drums, concrete culverts and casks and large steel boxes. This waste contains ~680,000 curies. The primary isotopes are plutonium-239 and plutonium-238. The waste is physically stored on 22 concrete pads. Ten of these pads are enclosed and contain 55- and 83-gallon waste drums. Boxes, culverts and casks are stored on non-enclosed pads. Mixed waste is stored and will be sorted and segregated to allow waste to be readied for shipment to offsite treatment facilities.

The site recently began operations in support of the shipment of waste to WIPP. Initial operations are focused on relatively low activity 55-gallon drums of TRU waste. Facilities in operation include characterization/certification facilities (assay, x-ray, headspace gas analysis), both fixed and provided by mobile vendors, Visual Examination (VE) facilities and TRUPACT-II loading facilities, both fixed and mobile. Additional capabilities are also planned to prepare the highest of activity waste drums and all other containers including culverts, casks and steel boxes for disposal to WIPP.

Area Hazards

E Area is positioned on a topographic and hydrogeologic divide; therefore, two conceptual site models for E Area are provided in Figures 4.11b.1, *E-Area CSM Fourmile Branch Watershed* and 4.11b.2, *E-Area CSM for Upper Three Runs Watershed* in Appendix J, *Area Conceptual Site Models and Hazard Tables*, and depict the potential sources of contamination, migration pathways, exposure media and potential receptors. Table 4.3, *Alternative Planned End State by Areas*, provides a listing of the E-Area waste units with associated characteristics. With the exception of G-Area waste units previously discussed with the

appropriate watershed, the major hazards in E Area that require further evaluation and potential remediation are the Old Radioactive Waste Disposal Facility (including Solvent Tanks), Low-Level Radioactive Waste Disposal Facility, and the Mixed Waste Management Facility (Groundwater).

Area Cleanup Status

Table 4.3a, *Alternative Planned End State by Areas*, provides the current remedial status for the E-Area waste units and the remedial technology implemented for completed units. For waste units in the “to go” phase where the response action has not been selected, Table 4.4a, *Alternative Hazard Type Crosswalk for Area "To Go" Units*, depicts a crosswalk that categorizes each of the “to go” units” to a hazard type CSM located in Appendix K, *Conceptual Site Models for Typical SRS Hazards (Soil, Groundwater, EM Facilities, LRW Tanks)*. The hazard type CSMs list the remedial technologies likely to be implemented for each hazard type. The “to go” waste units will undergo characterization, risk analysis, and evaluation for the appropriate remedial technologies.

Remediation for four of the seven E-Area waste units is complete (see Table 4.3a, *Alternative Planned End State by Areas*). For the remaining three “to go” waste units, two units are categorized as Hazard Type 1 (Burial Ground Complex) and one unit as Hazard Type 10 (Groundwater). Hazard sources to be evaluated for the remaining E-Area waste units include a variety of radioactive burials, nonradioactive rubble and building debris, organic and inorganic constituents.

Remedial technologies for groundwater are presented with each Hazard Type CSM in Appendix K, *Conceptual Site Models for Typical SRS Hazards (Soil, Groundwater, EM Facilities, and LRW Tanks)*. The Mixed Waste Management Facility is the only E-Area groundwater waste

unit in the “to go” phase. The groundwater pathways with impacted media and receptors are shown on Figures 4.11b.1 and 4.11.2, *E-Area CSM for Four Mile Branch Watershed and E-Area CSM for Upper Three Runs, respectively*. Groundwater monitoring indicates several plumes emanating from the Burial Ground Complex. Including the Northwest, Northeast, Southwest, and Southeast Plumes. Groundwater contaminants identified in the Burial Ground Complex Groundwater include 1, 1-dichlorethylene, carbon tetrachloride, PCE, TCE, radium, tritium, and uranium-238. Contaminated groundwater outcrops along seep locations in Fourmile Branch.

Area Planned End State Hazards

The current and projected end state for E-Area waste units is to accommodate a final risk level of 10^{-4} to 10^{-6} with institutional controls for the industrial worker and below MCLs for groundwater.

Mission and Facility End State

All legacy TRU waste currently in storage will have been processed and shipped to WIPP for disposal or disposed of in alternative disposal facilities by the end of 2006. Facility operations would continue on a limited basis to process any newly generated waste not certifiable for direct shipment. However, because EM will not need any SRS facilities after 2025, they may be deactivated and decommissioned, primarily by in-situ disposal except for the Solid Waste Disposal Facility in E Area. Before demolishment, facilities will be evaluated per the CRMP for historic preservation and the local economic outreach initiative. A final remedy for a large portion of E Area containing the 200-acre Old Radioactive Waste Burial Ground – the highest risk posed by the 515 cleanup projects in the SRS Environmental Restoration Program – will be finished in 2008. It is likely low-level radioactive waste generated by SRS tenants or

the Naval Nuclear Propulsion Program will continue to be buried within the Solid Waste Disposal Facility after 2025, but the volume will be extremely small. Hazardous, low-level, and radioactive mixed waste will be shipped directly to a commercial vendor for treatment and disposal. TRU will be shipped to New Mexico for geologic disposal. A perimeter fence will secure any remaining E-Area facilities.

Below is a table showing the number of nuclear, radiological and industrial facilities in E Area. End states are shown as either demolished or in situ. This information is based on the *SRS EM D&D Plan*, which did not account for reuse by other federal facilities or economic development or for historic preservation.

D&D has been completed on the E Area facilities that will be encompassed by the cap to be placed over the Old Burial Ground. D&D of the remaining E Area facilities will occur near the end of the EM mission at SRS or will be transferred to other organizations for continuing missions.

E Area Totals			End State	
Facility Haz Type	No.	Sq Ft	DEM	ISD
Nuc	16	255,299	13	3
Rad	0	0	0	0
Oth Ind	7	24,040	6	1
Total	23	279,339	19	4

Table 4.7 E-Area D&D Table

NOTE: Information provided in this table is based on the *DOE/WSRC Contract No. DE-AC09-96R18500, Modification Number 100*, and *the Savannah River Site Environmental Management Integrated Deactivation and Decommissioning Plan*, Rev. 1, September 30, 2003. Current status is shown facilities completed as of the end of fiscal year 2003 (September 30, 2003).

4.4.6 F Area

Area Description

F Area primarily comprises heavy nuclear industrial, warehouse, and administrative facilities. F-Area waste units are located in the Fourmile Branch and Upper Three Runs Watersheds. The current land use for F Area is site industrial.

Mission Description

F Area facilities include the F-Canyon Building, Depleted Uranium (DU) Processing Facility, FB-Line Facility, Metallurgical Facilities, Naval Fuels Building, Central Analytical Laboratory, the Mock-up/Fabrication Facility, medical facilities, and the F-Area Tank Farm. F Area is one of the two areas located near the center of SRS where nuclear chemical separations and waste management operations are performed. The primary function of these facilities is to stabilize special nuclear material (SNM) from spent fuels, irradiated targets, and other legacy nuclear materials and to evaporate and store the liquid radioactive waste generated by these operations.

Chemical separation and purification of these materials is accomplished in facilities known as canyons. The canyons are supported by ancillary facilities that provide further chemical conversion, cold chemical feeds, or general facility services. F-Area Canyon and H-Area Canyon are the only two nuclear chemical processing and separations facilities in the DOE Complex. In 2003 DOE began to phase out the F-Area Canyon with deactivation expected to be completed by 2006. The remaining reprocessing needs will be met by the H-Area Canyon.

High-level liquid waste evaporation and storage is accomplished in the F-Tank Farm (FTF). The purpose of FTF is to safely store and manage an inventory of approximately 16 million gallons (130 million curies) of liquid radioactive waste

in 20 underground storage tanks. This waste has accumulated from nuclear material production operations at the Savannah River Site.

These interim storage tanks were built underground to provide shielding from the intense radiation fields of the highly radioactive waste. Originally there were 22 of these waste storage tanks, but two have been emptied and operationally closed. The waste tanks range in volume between 750,000 gallons and 1.3 million gallons (each with systems for leak detection, liquid level monitoring, ventilation, combustible gas monitoring, temperature monitoring and cooling, and remote inspection).

In addition to the tanks, FTF also contains two evaporator systems, two control rooms, cooling water systems, waste transfer systems, and other support structures (offices, maintenance shops, equipment/material storage, etc.).

The former Naval Fuels facility in F Area has been deactivated and is safely maintained in a low-cost surveillance and maintenance mode. D&D activities are proceeding to remove this facility.

Area Hazards

F Area is positioned on a topographic and hydrogeologic divide; therefore, two conceptual site models for F Area are provided in Figures 4.12b.1, *F-Area CSM for Fourmile Branch Watershed* and 4.12b.2, *F-Area CSM for Upper Three Runs Watershed*, which depict the potential sources of contamination, migration pathways, exposure media and potential receptors.

Nuclear facilities in F Area contain residual plutonium oxide and neptunium oxide contamination in facilities that are no longer operable (Actinide Billet Line, Plutonium Fuel Form Facility and the Plutonium Experimental Facility). Further evaluation and potential remediation of this residual contamination

hazards will occur in planning for its decommissioning and area closure.

Table 4.3a, *Alternative Planned End State by Areas*, provides a listing of the F-Area waste units with associated characteristics. With the exception of G-Area waste units previously discussed with the appropriate watershed, the major hazards in F Area that require further evaluation and potential remediation are the Combined Spills from 242-F, 643-G and 701-1F, F-Area Retention Basin, F-Area Tank Farm, and the F-Area Inactive Process Sewer Lines. In addition, the F&H-Area Hazardous Waste Management Facilities (HWMF) and the General Separations Western Groundwater Operable Unit are the two groundwater units in F Area with major hazards.

Area Cleanup Status

Table 4.3a, *Alternative Planned End State by Areas*, provides the current remedial status for the F-Area waste units and the remedial technology implemented for completed units. For waste units in the “to go” phase where the response action has not been selected, Table 4.4a, *Alternative Hazard Type Crosswalk for Area "To Go" Units*, depicts a crosswalk that categorizes each of the “to go” units” to a hazard type CSM located in Appendix K, *Conceptual Site Models for Typical SRS Hazards (Soil, Groundwater, EM Facilities, LRW Tanks)*. The hazard type CSMs list the remedial technologies likely to be implemented for each hazard type. The “to go” waste units will undergo characterization, risk analysis, and evaluation for the appropriate remedial technologies.

Remediation for 35 of the 64 F-Area waste units is complete (Table 4.3). For the remaining 29 “to go” waste units, two units are categorized as Hazard Type 2 (Radiological Seepage Basins and Pits), two units as Hazard Type 3 (Coal Pile Runoff Basins and Ash Basins), two units as Hazard Type 4 (Inactive Process Sewer Lines),

21 units as Hazard Type 9 (Miscellaneous Sites) and two units as Hazard Type 10 (Groundwater). Hazard sources to be evaluated for the remaining F-Area waste units include radionuclides, nonradioactive rubble and building debris, organic and inorganic constituents.

Remedial technologies for groundwater are presented with each Hazard Type CSM in Appendix K. The groundwater pathways with impacted media and receptors are shown on Figures 4.12b.1, *F-Area CSM for Fourmile Branch Watershed*, and 4.12b.2, *F-Area CSM for Upper Three Runs Watershed*. The F&H-Area HWMF and the General Separations Western Groundwater Operable Unit are the two remaining groundwater units in F-Area. Groundwater underlying the F-Area HWMF has been impacted by F-Area operations. Metals, nitrate, organics, tritium and other radionuclides are present above MCLs in the groundwater beneath the F-Area seepage basins. Sampling at seep locations indicates that contaminated groundwater continues to impact the Fourmile Branch IOU.

The General Separations Area (GSA) Western Groundwater Operable Unit (OU) encompasses approximately 1100 acres in the northwest portion of the General Separations areas and includes the previous F-Area Canyon Groundwater OU and the F-Area Tank Farm Groundwater OU. The boundaries of the Western Groundwater OU include the Upper Three Runs to the west and north; an unnamed tributary to Upper Three Runs Creek, the MWMF, and the Old Radioactive Waste Burial Ground to the east. Metals, VOCs, and radionuclides are present in the groundwater at levels that exceed MCLs. The plumes are migrating towards the Upper Three Runs Creek and may impact the Upper Three Runs IOU.

Area Planned End State Hazards

The current and projected end state for F-Area waste units is to accommodate a final risk level of 10^{-4} to 10^{-6} with institutional controls for the industrial worker and below MCLs for groundwater.

Mission and Facility End State

F Canyon, FB Line, and ancillary facilities will be decommissioned by in-situ disposal. One F-Area facility will remain operable through 2009 in support of the plutonium surveillance mission. At that time, this facility will be deactivated and decommissioned by in situ disposal and any remaining administrative facilities in F Area would be demolished or made available for reuse by another DOE or federal program.

All LRW Tanks in FTF will have been closed (removed from service and filled with grout). In addition, the 1F and 2F Evaporators and contaminated waste transfer systems would have been closed by isolating utilities and filling with grout. All above-ground buildings or structures will be demolished, and a perimeter fence will secure any remaining F Area facilities.

Before in situ disposal or demolition of any facilities, they will be evaluated per the CRMP for historic preservation and the local economic outreach initiative. The following buildings have already been identified for the local economic outreach initiative: 709-4F and 709-5F, Fire Equipment Shelters.

Below is a table showing the number of nuclear, radiological and industrial facilities in F Area. End states are shown as either demolished or in situ. This information is based on the *SRS EM D&D Plan*, which did not account for reuse by other federal facilities or economic development or for historic preservation.

D&D has been initiated on the majority of the F Canyon administrative and industrial support facilities including the Canyon Outside Facilities. The main separations facility (F Canyon) is undergoing deactivation and will be placed in a safe store condition until final D&D is initiated. D&D of the Central Laboratory Facility and the F Tank Farm Facilities will not be initiated until the later portion of the EM mission at the site.

F Area Totals			End State	
Facility Haz Type	No.	Sq Ft	DEM	ISD
Nuc	36	698,359	29	7
Rad	10	200,924	8	2
Oth Ind LRW Tanks	93 22	382,010 N/A	91 0	2 22
Total	161	1,281,293	128	33

Table 4.8 F-Area D&D Table

NOTE: Information provided in this table is based on the *DOE/WSRC Contract No. DE-AC09-96R18500, Modification Number 100*, and the *Savannah River Site Environmental Management Integrated Deactivation and Decommissioning Plan*, Rev. 1, September 30, 2003. Current status is shown facilities completed as of the end of fiscal year 2003 (September 30, 2003).

4.4.7 G Area

Mission Description

G Area is the area outside of site process areas, encompassing over 95 percent of the site. This area includes USFS-SR facilities, a rail network, Research Set-Aside Areas supporting the National Environmental Research Park (NERP), habitat and forest management areas, environmental monitoring activities, and facilities to support subcontractors. The developed portions of G Area primarily are

comprised of light industrial, warehouse, and administrative facilities.

Information on area hazards, cleanup status, and planned end states can be found in the Watershed discussions in Section 4.3, Hazard Specific Discussion by Watersheds.

Mission and Facility End State

There are no new major facilities planned for G Area. Under the proposed reconfiguration, by 2020, the USFS-SR administrative and educational program functions could be located to new facilities in B Area. In addition to the facilities in B Area, the USFS-SR would also maintain strategically placed fire protection equipment and maintenance materials and equipment elsewhere around the site. The USFS-SR buildings currently located in G Area may be removed, subject to an evaluation per the CRMP for historic preservation and the local economic outreach initiative. Building 647-G has already been identified for the local economic outreach initiative. The following information is based on the *SRS EM D&D Plan*, which did not account for reuse by other federal facilities or economic development or for historic preservation.

D&D has been initiated on a limited number of the outlying G area facilities.

G Area Totals			End State	
Facility Haz Type	No.	Sq Ft	DEM	ISD
Nuc	0	0	0	0
Rad	0	0	0	0
Oth Ind	102	249,480	88	14
Total	102	249,480	88	14

Table 4.9 G-Area D&D Table

NOTE: Information provided in this table is based on the *DOE/WSRC Contract No. DE-AC09-96R18500, Modification Number 100*, and

the Savannah River Site Environmental Management Integrated Deactivation and Decommissioning Plan, Rev. 1, September 30, 2003. Current status is shown facilities completed as of the end of fiscal year 2003 (September 30, 2003).

4.4.8 H Area

Area Description

H Area is primarily comprised of heavy nuclear industrial, warehouse, and administrative facilities. H-Area waste units are located in the Fourmile Branch and Upper Three Runs Watersheds. The current land use for H Area is site industrial.

Mission Description

H Area is the second of the two nuclear chemical separation areas at SRS. H-Area facilities (H Canyon and HB Line) are used to stabilize nuclear materials. H Outside Facilities, which is adjacent to H Canyon/HB Line, supports separation processes by providing bulk chemical storage, liquid waste disposal, and nuclear material storage.

DOE plans to phase out its reprocessing capabilities and use of the canyons but must balance this closure with the need to stabilize fissile materials. Implementation of the 1992 decision by the Secretary of Energy to phase out canyon operations at SRS is proceeding with the use of the canyons limited to stabilizing certain deteriorating SNF, plutonium compounds, and other nuclear materials to forms suitable for safe and secure, long-term storage or disposition. After the H-Area Canyon/HB-Line processing commitments are completed, they will be deactivated.

The current missions of the H-Area Canyon include dissolution of Mark-16/22 and other SNF, dissolution of plutonium and enriched uranium residues, conversion of plutonium-239

and neptunium-237 to oxide, and blenddown of highly-enriched uranium solution to allow a low enrichment uranium solution of five percent enrichment to support the Tennessee Valley Authority (TVA) program for commercial power reactor fuel.

H Area also houses the Receiving Basin for Offsite Fuels (RBOF), which has been deinventoried.

High-level liquid radioactive waste is stored, evaporated, and pretreated for vitrification in H Area. The LRW facilities consist of the portion of this area known as H-Tank Farm (HTF). The purpose of the HTF Facility is to safely store and manage an inventory of approximately 21 million gallons (300 million curies) of liquid radioactive waste in 29 underground storage tanks and to pre-treat the sludge portion of this waste to enable final processing at DWPF. This waste has accumulated from nuclear material production operations at SRS. These interim storage tanks were built underground to provide shielding from the intense radiation fields of the highly radioactive waste. All but one of the 29 tanks are currently in use. The waste tanks range in volume between 750,000 gallons and 1.3 million gallons (each with systems for leak detection, liquid level monitoring, ventilation, combustible gas monitoring, temperature monitoring and cooling, and remote inspection).

In addition to the tanks, HTF also contains three evaporator systems, three control rooms, waste pre-treatment buildings, cooling water systems, waste transfer systems, and other support structures (offices, maintenance shops, equipment/material storage, etc.).

The Consolidated Incineration Facility (CIF), also located in H Area, was designed and constructed to thermally treat and reduce the volume of low-level hazardous and mixed wastes. The CIF is currently shutdown and is

maintained under a minimum surveillance and maintenance regimen.

The Effluent Treatment Project (ETP) collects and treats low-level radioactively and chemically contaminated wastewater from the LRW Program and the Nuclear Materials Management Program by removing chemical and radioactive contaminants before discharging the water.

Activities for the Defense Program, tritium extraction and recycle, also occur in H Area. The Tritium Facilities consists of four main buildings. Three of these buildings have operated for many years. These buildings are the second generation tritium structures built onsite, and they house a number of key operations, including reclamation of previously used tritium reservoirs; receipt, packaging and shipping of reservoirs; recycling and enrichment of tritium gas; and several key laboratory and maintenance shop areas.

In 1994, tritium operations began in the newest structure, , which was referred to as the Replacement Tritium Facility during construction. Operations conducted in this building include unloading gases from reservoirs returned from the Department of Defense, separating and purifying the useful hydrogen isotopes (tritium and deuterium), mixing the gases to exact specifications, loading the reservoirs, and performing various reservoir performance tests (e.g., function testing, environmental conditioning).

The Tritium Facility Modernization and Consolidation (TFM&C) Project relocated several existing process systems and equipment, as well as laboratory functions. The TFM&C modifications provide sufficient processing capability and capacity to support the Tritium Extraction Facility. Other processes or laboratory facilities include the environmental storage and metallurgical operations.

Following completion of TFM&C, Building 232-H began a yearlong deactivation process in accordance with DOE Order 430.1B, *Real Property Asset Management*. This building will remain in long-term surveillance and maintenance until after 2025 to allow tritium contamination to decay sufficiently for safe demolition. The half-life of tritium is 12.3 years.

The Tritium Extraction Facility (TEF), which has been designed for a 40-year operating life, will provide the capability to receive Tritium-Producing Burnable Absorber Rods from the Tennessee Valley Authority reactor at Watts Barr, Tennessee, and extract tritium-containing gases.

Other H-Area facilities include medical, warehouse, and training facilities. H-Area warehouse facilities provide material coordination, acquisition, and processing for numerous SRS operations; and their conditions vary from poor to good.

Area Hazards

H Area is positioned on a topographic and hydrogeologic divide; therefore, two conceptual site models for H-Area are provided in Figures 4.13b.1, *H-Area CSM for Fourmile Branch Watershed*, and 4.13b.2, *H-Area CSM for Upper Three Runs Watershed*, which depict the potential sources of contamination, migration pathways, exposure media and potential receptors. Table 4.3a, *Alternative Planned End State by Areas*, provides a listing of the H-Area waste units with associated characteristics. Nuclear facilities in H Area contain residual plutonium oxide and neptunium oxide contamination in facilities that are no longer operable. With the exception of G-Area waste units previously discussed with the appropriate watershed, the major hazards in H Area that require further evaluation and potential remediation are the H-Area Retention Basins, H-

Area Process Sewer Lines, H-Area Inactive Process Sewer Lines, Warner's Pond, H-Area Retention Basin, HP-52 Ponds, and the General Separations Area Eastern Groundwater Operable Unit.

Area Cleanup Status

Table 4.3a, *Alternative Planned End State by Areas*, provides the current remedial status for the H-Area waste units and the remedial technology implemented for completed units. For waste units in the "to go" phase where the response action has not been selected, Table 4.4a, *Alternative Hazard Type Crosswalk for Area "To Go" Units*, depicts a crosswalk that categorizes each of the "to go" units" to a hazard type CSM located in Appendix K, *Conceptual Site Models for Typical SRS Hazards (Soil, Groundwater, EM Facilities, LRW Tanks)*. The hazard type CSMs list the remedial technologies likely to be implemented for each hazard type. The "to go" waste units will undergo characterization, risk analysis, and evaluation for the appropriate remedial technologies.

Remediation for 19 of the 54 H-Area waste units is complete (Table 4.3). For the remaining 35 "to go" waste units, seven units are categorized as Hazard Type 2 (Radiological Seepage Basins and Pits), two units as Hazard Type 3 (Coal Pile Runoff Basins and Ash Basins), two units as Hazard Type 4 (Inactive Process Sewer Lines), 23 units as Hazard Type 9 (Miscellaneous Sites) and one unit as Hazard Type 10 (Groundwater). Hazard sources to be evaluated for the remaining H-Area waste units include radionuclides, nonradioactive rubble and building debris, organic and inorganic constituents.

Remedial technologies for groundwater are presented with each Hazard Type CSM in Appendix K, *Conceptual Site Models for Typical SRS Hazards (Soil, Groundwater, EM Facilities, and LRW Tanks)*. The groundwater pathways with impacted media and receptors are shown on

Figures 4.13b.1, *H-Area CSM for Fourmile Branch Watershed*, and 4.13b.2, *H-Area CSM for Upper Three Runs Watershed*. The General Separations Area (GSA) Eastern Groundwater OU is the only groundwater unit in H-Area that has not completed remediation. The GSA Eastern Groundwater OU includes the previous groundwater systems associated with the H-Area Tank Farm Groundwater OU and other operating facilities and waste units. Metals, VOCs, and radionuclides are present in the Eastern Groundwater OU at levels that exceed MCLs. However, these exceedances are sporadic and localized and no definable plumes appear to emanate from a single operating facility or waste unit.

Area Planned End State Hazards

The current and projected end state for H-Area waste units is to accommodate a final risk level of 10^{-4} to 10^{-6} with institutional controls for the industrial worker and below MCLs for groundwater.

Mission and Facility End State

Subject to a review per the CRMP for historic preservation and for the local economic outreach initiative, H Canyon, HB Line, the Receiving Basin for Offsite Fuels and ancillary facilities will be deactivated before final disposition, currently scheduled to be in-situ disposal. In-situ disposal of the LRW tanks means that empty tanks will be removed from service and filled with grout. In addition, the 1H, 2H, and 3H Evaporators and contaminated waste transfer systems may be decommissioned by isolating the equipment from all utilities before the evaporators are stabilized structurally with grout. All above-ground buildings including the Consolidated Incinerator Facility and Effluent Treatment Facility may be demolished. A perimeter fence will secure any remaining H Area facilities.

NNSA will decide whether tritium processing operations will continue at SRS after 2025.

Below is a table showing the number of nuclear, radiological and industrial facilities in H Area. End states are shown as either demolished or in situ. This information is based on the *SRS EM D&D Plan*, which did not account for reuse by other federal facilities or economic development or for historic preservation.

D&D has been initiated on a limited number of H Area facilities as the majority of the facilities in this area will continue to operate until the later portion of the EM mission.

H Area Totals			End State	
Facility Haz Type	No.	Sq Ft	DEM	ISD
Nuc	52	461,958	37	15
Rad	20	263,835	16	4
Oth Ind LRW Tanks	93	431,672	87	6
	29	N/A	0	29
Total	194	1,157,465	140	54

Table 4.10 H-Area D&D Table

NOTE: Information provided in this table is based on the *DOE/WSRC Contract No. DE-AC09-96R18500, Modification Number 100*, and *the Savannah River Site Environmental Management Integrated Deactivation and Decommissioning Plan*, Rev. 1, September 30, 2003. Current status is shown facilities completed as of the end of fiscal year 2003 (September 30, 2003).

4.4.9 K Area

Area Description

K Area is a 3,558 acre area with all K-Area waste units located in the Pen Branch Watershed. The current land use for K Area is site industrial.

Mission Description

K Area is one of five SRS reactor areas with the original mission of producing material for the Department of Defense nuclear weapons program. K Reactor is similar in size and layout to the other reactor areas. The K-Area production reactor is in shutdown condition with no capability of restart. The K-Area Disassembly Basin has been deinventoried and deactivated. K Area also serves to temporarily receive and store plutonium, highly-enriched uranium fuel, and large amounts of tritiated heavy water consolidated from other facilities. K Area is primarily comprised of heavy nuclear industrial, administrative, safeguards and security, and some warehouse facilities.

Current K-Area activities include all programmatic and physical support efforts related to safe storage of Special Nuclear Materials (SNM) already referenced and from F Area and offsite sources. K Area is being used temporarily to store plutonium, Highly Enriched Uranium, and large volume of heavy water that has been contaminated by tritium.

Facility modifications have been completed to allow receipt and storage of plutonium in K Area. The modifications facilitate the early deinventory and shut down of the Rocky Flats Environmental Technology Site (RFETS) to avoid an estimated \$1.3 billion in operating costs. The K-Area facility is currently designed to store up to 5,000 containers and is being used temporarily to store plutonium, highly enriched uranium, and a large volume of heavy water that has been contaminated with tritium. All surplus fissile material and tritiated heavy water will be dispositioned. This material will be dispositioned by 2020. Presently, 10 K-Area facilities have been declared inactive.

Area Hazards

The conceptual site model for K Area is provided in Figure 4.14b, *K-Area CSM for Pen Branch Watershed* in Appendix J, *Area Conceptual Site Models and Hazard Tables*, and depicts the potential sources of contamination, migration pathways, exposure media and potential receptors. *Table 4.3a, SRS End State Vision Planned by Area* in Appendix J, *Area Conceptual Site Models and Hazard Tables*, provides a listing of the K-Area waste units with associated characteristics. With the exception of G-Area waste units previously discussed with the appropriate watershed, the major hazards in K Area that require further evaluation and potential remediation are the K-Area Disassembly Basin, K-Area Reactor Discharge Canal, K-Reactor Area Cask Car Railroad Tracks, and K-Area Reactor Groundwater.

Area Cleanup Status

Table 4.3a, Alternative Planned End State by Areas, provides the current remedial status for the K-Area waste units and the remedial technology implemented for completed units. For waste units in the “to go” phase where the response action has not been selected, *Table 4.4a, Alternative Hazard Type Crosswalk for Area "To Go" Units*, depicts a crosswalk that categorizes each of the “to go” units” to a hazard type CSM located in Appendix K. The hazard type CSMs list the remedial technologies likely to be implemented for each hazard type. The “to go” waste units will undergo characterization, risk analysis, and evaluation for the appropriate remedial technologies.

Remediation for 18 of the 26 K-Area waste units is complete (*Table 4.3*). For the remaining eight “to go” waste units, three units are categorized as Hazard Type 2 (Radiological Seepage Basins and Pits), one unit as Hazard Type 3 (Coal Pile Runoff Basins and Ash Basins), one unit as Hazard Type 5 (Nonradiological Rubble Piles

and Pits), one unit as Hazard Type 7 (Sludge Application Sites), one unit as Hazard Type 9 (Miscellaneous Sites), and one unit as Hazard Type 10 (Groundwater). Hazard sources to be evaluated for the remaining K-Area waste units include radionuclides, nonradioactive rubble and building debris, organic and inorganic constituents.

Remedial technologies for groundwater are presented with each Hazard Type CSM in Appendix K, *Conceptual Site Models for Typical SRS Hazards (Soil, Groundwater, EM Facilities, and LRW Tanks)*. K-Area groundwater is the only K-Area groundwater waste unit in the “to go” phase. The groundwater pathways with impacted media and receptors are shown on Figure 4.14b, *K-Area CSM for Pen Branch Watershed*. Tritium and organics plumes have been identified to date, but groundwater characterization has not been completed, and a complete list of contaminants has not been completed. The K-Area Tritium Anomaly (previously Waste Unit 90) was combined with K-Area Groundwater. The anomaly was identified during quarterly groundwater sampling in 1990 by significant increases in tritium in seepage basin wells. Based on modeling predictions, groundwater from K-Area flows to Indian Grave Branch and Pen Branch where it discharges to the streams. There is the potential that contaminated groundwater impacts the Pen Branch IOU.

Area Planned End State Hazards

The current and projected end state for K-Area waste units is to accommodate a final risk level of 10^{-4} to 10^{-6} with institutional controls for the industrial worker and below MCLs for groundwater.

Mission and Facility End State

Following plutonium deinventory (approximately 2020), the K Area Building and

associated facilities would begin deactivation unless turned over to another Lead Program Secretarial Office for further use. However, prior to this time, there will be some K Area facilities, not associated with the Special Nuclear Materials Program, which may have been decommissioned.

All surplus fissile material and tritiated heavy water will be dispositioned. By 2025 all hardened reactor facilities may be decommissioned by in-situ disposal and all non-hardened buildings and structures in K Area may be demolished. A perimeter fence will secure any remaining K Area facilities.

Before any facilities are dispositioned, demolished, or in situ disposed, they will be evaluated per the CRMP for historic preservation and for the local economic outreach initiative.

Below is a table showing the number of nuclear, radiological and industrial facilities in K Area. End states are shown as either demolished or in situ. This information is based on the *SRS EM D&D Plan*, which did not account for reuse by other federal facilities or economic development or for historic preservation. This information is based on the *SRS EM D&D Plan*, which did not account for reuse by other federal facilities or economic development or for historic preservation.

Due to continuing nuclear material storage mission in K Area only limited D&D will be performed until the later portion of the EM Mission at the site.

K Area Totals			End State	
Facility Haz Type	No.	Sq Ft	DEM	ISD
Nuc	2	388,326	1	1
Rad	0	0	0	0
Oth Ind	32	447,398	23	9
Total	34	835,724	24	10

Table 4.11 K-Area D&D Table

NOTE: Information provided in this table is based on the *DOE/WSRC Contract No. DE-AC09-96R18500, Modification Number 100*, and the *Savannah River Site Environmental Management Integrated Deactivation and Decommissioning Plan, Rev. 1, September 30, 2003*. Current status is shown facilities completed as of the end of fiscal year 2003 (September 30, 2003).

4.4.10 L Area

Area Description

L Area is an upland site region between Steel Creek and Pen Branch located approximately 1.9 miles southwest of the geographical center of SRS and about 6 miles northwest of the nearest site boundary. L-Area waste units are located in both the Steel Creek and the Pen Branch Watersheds. The current land use for L Area is site industrial.

Mission Description

L Area is one of five SRS reactor areas with the original mission of producing material for the Department of Defense nuclear weapons program. The area is similar in size and layout to the other reactor areas. The L-Area production reactor is in shutdown condition with no capability of restart. However, the L-Area Disassembly Basin currently plays a crucial role in DOE's Spent Nuclear Fuel (SNF) mission.

Irradiated fuel assemblies have been stored in the disassembly basins since discharge from the reactors. Additional SNF is being, and will be, received and stored at SRS from offsite domestic and foreign research reactors, with offsite SNF receipts projected through the year 2019. L Area also provided space for consolidation of the D-Area Heavy Water. L Area is primarily comprised of heavy nuclear industrial, administrative, safeguards and security, and some warehouse facilities.

Current L-Area activities include programmatic and physical support related to receipt and safe storage of SNF, shipments of irradiated fuel to the canyons to complete the basin deinventory, future stabilization of SNF, and heavy water storage. SNF activities help manage the wet basin storage of SNF inventories to allow receipt of projected shipments and provide safe storage until a new treatment and dry storage facility is available.

Presently, eight L-Area facilities have been declared inactive.

Area Hazards

L-Area is positioned on a topographic and hydrogeologic divide; therefore, two conceptual site models for L-Area are provided in Figures 4.15b.1, *L-Area CSM for Pen Branch Watershed*, and 4.15b.2, *L-Area CSM for Steel Creek Watershed*, depicts the potential sources of contamination, migration pathways, exposure media and potential receptors. Table 4.3a, *Alternative Planned End State by Areas*, provides a listing of the L-Area waste units with associated characteristics. With the exception of G-Area waste units previously discussed with the appropriate watershed, the major hazards in L Area that require further evaluation and potential remediation are the L-Reactor Area Cask Car Railroad Tracks, L-Area Hot Shop, and L-Area Southern Groundwater.

Area Cleanup Status

Table 4.3a, *Alternative Planned End State by Areas*, provides the current remedial status for the L-Area waste units and the remedial technology implemented for completed units. For waste units in the “to go” phase where the response action has not been selected, Table 4.4a, *Alternative Hazard Type Crosswalk for Area "To Go" Units*, depicts a crosswalk that categorizes each of the “to go” units” to a hazard type CSM located in Appendix K, *Conceptual Site Models for Typical Hazards*. The hazard type CSMs list the remedial technologies likely to be implemented for each hazard type. The “to go” waste units will undergo characterization, risk analysis, and evaluation for the appropriate remedial technologies.

Remediation for 17 of the 28 L-Area waste units is complete (Table 4.3). For the remaining 11 “to go” waste units, two units are categorized as Hazard Type 2 (Radiological Seepage Basins and Pits), one unit as Hazard Type 3 (Coal Pile Runoff Basins and Ash Basins), four units as Hazard Type 5 (Nonradiological Rubble Piles and Pits), two units as Hazard Type 9 (Miscellaneous Sites), and two units as Hazard Type 10 (Groundwater). Hazard sources to be evaluated for the remaining L-Area waste units include radionuclides, nonradioactive rubble and building debris, organic and inorganic constituents.

Remedial technologies for groundwater are presented with each Hazard Type CSM in Appendix K, *Conceptual Site Models for Typical Hazards*. L-Area Southern Groundwater and L-Area Northern Groundwater are the L-Area groundwater waste units in the “to go” phase. The groundwater pathways with impacted media and receptors are shown on Figures 4.15b.1, *L-Area CSM for Pen Branch Watershed*, and 4.15b.2, *L-Area CSM for Steel Creek Watershed*.

The L-Area Southern Groundwater OU encompasses all the groundwater south of L Reactor to L Lake. The L-Area Northern Groundwater has yet to be investigated. The L-Area Southern Groundwater OU investigation has identified groundwater contaminated with TCE, PCE, and tritium. Two distinct commingled plumes of tritium, TCE, and PCE exist south of the reactor and extend toward L Lake. Characterization data indicate that areas within the reactor perimeter fence are contributing sources to the plumes. A separate tritium plume exists to the west of the reactor area and is moving in a westward direction between Pen Branch and L Lake. Initial characterization and modeling indicate that the source of this plume is a retention basin located west of the reactor facility. Steel Creek is a gaining stream above L Lake and may be impacted by contaminated groundwater. The groundwater investigation is entering the next phase to define the extent of the contaminant plumes and results will be evaluated with regards to IOU impact in the next periodic report.

Area Planned End State Hazards

The current and projected end state for L-Area waste units is to accommodate a final risk level of 10^{-4} to 10^{-6} with institutional controls for the industrial worker and below MCLs for groundwater.

Mission and Facility End State

If EM is the programmatic owner of the L-Area facilities; the plan is to complete deinventory by the end of 2020 and deactivation by the end of 2022. By 2025 all hardened reactor facilities may be decommissioned by in-situ disposal and all non-hardened buildings and structures in L Area may be demolished. A perimeter fence will secure any remaining L Area facilities. Revised schedules and plans would be formulated if the facilities are turned over to a

non-EM government entity, and the facility scope and lifecycle baseline plan changes.

Before any facilities are dispositioned, demolished, or in situ disposed, they will be evaluated per the CRMP for historic preservation and for local economic outreach initiative.

Below is a table showing the number of nuclear, radiological and industrial facilities in L Area. End states are shown as either demolished or in situ. This information is based on the *SRS EM D&D Plan*, which did not account for reuse by other federal facilities or economic development or for historic preservation.

Due to continuing nuclear fuel storage mission in L Area only limited D&D will be performed until the later portion of the EM Mission at the site.

L Area Totals			End State	
Facility Haz Type	No.	Sq Ft	DEM	ISD
Nuc	1	385,010	0	1
Rad	1	4,087	1	0
Oth Ind	28	272,866	22	6
Total	30	661,963	23	7

Table 4.12 L-Area D&D Table

NOTE: Information provided in this table is based on the *DOE/WSRC Contract No. DE-AC09-96R18500, Modification Number 100*, and the *Savannah River Site Environmental Management Integrated Deactivation and Decommissioning Plan*, Rev. 1, September 30, 2003. Current status is shown facilities completed as of the end of fiscal year 2003 (September 30, 2003).

4.4.11 M Area

Area Description

M Area is located in the northwest part of SRS and is approximately one mile from the plant boundary and covers approximately 50 acres. D&D operations are currently being undertaken in M Area. M- Area waste units are located in the Upper Three Runs and Savannah River/Floodplain Swamp Watersheds. The current land use designation for M Area is site industrial.

Mission Description

M Area formerly manufactured nuclear fuel and target elements for use in the production reactors. M Area housed materials fabrication facilities to support reactor operations, similar to structures found in non-nuclear metal and finishing operations, and produced special fuel assemblies containing targets for the production of special nuclear materials. The area is composed of three large fuel and target facilities, two laboratories, a wastewater treatment facility, a low-level waste vitrification facility, and numerous support facilities. Residual contamination exists in most of these facilities, a legacy of past operations. Both laboratories have been deactivated as well as several other facilities. Deactivation of the wastewater treatment and the low-level waste vitrification facilities were completed in 2001.

Area Hazards

The conceptual site models for M-Area are provided in Figures 4.16b.1, *M-Area CSM for Upper Three Runs Watershed*, and 4.16b.2, *M-Area CSM for Savannah River/Floodplain Swamp Watershed*, and depict the potential sources of contamination, migration pathways, exposure media and potential receptors. Table 4.3a, *Alternative Planned End State by Areas*, provides a listing of the M-Area waste units with associated characteristics. With the exception of

G-Area waste units previously discussed with the appropriate watershed, the major hazards in M Area that require further evaluation and potential remediation are the M-Area Settling Basin Inactive Process Sewers to Manhole 1, Underground Sumps 321 M #001 and 321 M #002, 313-M and 320-M Inactive Clay Process Sewers to Tims Branch, Spill on 12/01/71 of 1,000 gallons of radioactive water from 773-A, M-Area Hazardous Waste Management Facility: A/M Area Groundwater Portion (Groundwater), and Savannah River Laboratory (SRL) Groundwater (Groundwater).

Area Cleanup Status

Table 4.3a, *Alternative Planned End State by Areas*, provides the current remedial status for the M-Area waste units and the remedial technology implemented for completed units. For waste units in the “to go” phase where the response action has not been selected, Table 4.4a, *Alternative Hazard Type Crosswalk for Area "To Go" Units*, depicts a crosswalk that categorizes each of the “to go” units” to a hazard type CSM located in Appendix K, *Conceptual Site Models for Typical Hazards*. The hazard type CSMs list the remedial technologies likely to be implemented for each hazard type. The “to go” waste units will undergo characterization, risk analysis, and evaluation for the appropriate remedial technologies.

Remediation for 45 of the 53 M-Area waste units is complete (Table 4.3). For the remaining 8 “to go” waste units, five units are categorized as Hazard Type 4 (Inactive Process Sewer Lines), one as Hazard Type 9 (miscellaneous sites) and two as Hazard Type 10 (groundwater). Hazard sources to be evaluated for the remaining M-Area waste units include a variety of radioactive releases, nonradioactive rubble and building debris, organic and inorganic constituents.

Remedial technologies for groundwater are presented with each Hazard Type CSM in Appendix K, *Conceptual Site Models for Typical SRS Hazards (Soil, Groundwater, EM Facilities, and LRW Tanks)*. The groundwater pathways with impacted media and receptors are shown on Figures 4.16b.1b, *M-Area CSM for Upper Three Runs Watershed*, and 4.16b.2, *M-Area CSM for Savannah River/Floodplain Swamp Watershed*. The M-Area Hazardous Waste Management Facility: A/M Area Groundwater Portion and SRL Groundwater are the two remaining groundwater units in M Area. These groundwater plumes are commingled and encompass approximately three square miles. This groundwater contamination underlies a large portion of A/M Area, but it is presented here in the M-Area discussion to avoid repetition. Groundwater associated with the M-Area Hazardous Waste Management Facility: A/M Area Groundwater Portion has been impacted by A/M-Area operations. VOC contamination (trichloroethylene, perchloroethylene, and 1,1,1-trichloroethane) is present above MCLs in this groundwater unit.

The SRL Groundwater OU addresses contaminated groundwater beneath SRNL (formerly SRL) complex. Operations in research and laboratory facilities within the complex resulted in the release of contaminants (including volatile organic compounds [VOCs] and radionuclides above MCLs) to the subsurface. This groundwater plume extends towards Tims Branch beneath the unnamed tributary located east of A Area. There is no indication at this time that the plume has impacted surface water.

The remediation program for both groundwater units includes a series of soil vapor extraction units, a network of recovery and recirculation wells, and innovative remedial technologies.

Area Planned End State Hazards

The current and projected end state for M-Area waste units is to accommodate a final risk level of 10^{-4} to 10^{-6} with institutional controls for the industrial worker and below MCLs for groundwater.

Mission and Facility End State

All structures in M Area may be demolished as part of the EM Closure Project after evaluation per the CRMP for historic preservation and the local economic outreach initiative. The following buildings have been identified for the local economic outreach initiative: 315-M, Radiological Operation Support Center; 316-M, Drum Storage Facility; and 316-1M, Chemical Storage Pad. Below is a table showing the number of nuclear, radiological and industrial facilities in M Area. End states are shown as either demolished or in situ. This information is based on the *SRS EM D&D Plan*, which did not account for reuse by other federal facilities or economic development or for historic preservation.

D&D has been initiated on all of M area buildings to support the area closure schedule.

M Area Totals			End State	
Facility Haz Type	No.	Sq Ft	DEM	ISD
Nuc	0	0	0	0
Rad	2	32,490	2	0
Oth Ind	18	308,647	18	0
Total	20	341,137	20	0

Table 4.13 M-Area D&D Table

NOTE: Information provided in this table is based on the *DOE/WSRC Contract No. DE-AC09-96R18500, Modification Number 100*, and the *Savannah River Site Environmental Management Integrated Deactivation and*

Decommissioning Plan, Rev. 1, September 30, 2003. Current status is shown facilities completed as of the end of fiscal year 2003 (September 30, 2003).

4.4.12 N AreaArea Description

N Area was previously designated Central Shops and consists of about 100 acres of buildings and storage areas centrally located between the reactors and separations areas. Many of the N-Area facilities have been retired and have been designated as waste units. N-Area waste units are located in the Fourmile Branch and Pen Branch Watersheds. The current land use for N Area is site industrial.

Mission Description

N Area contains construction services facilities such as electrical, mechanical, material and equipment lay-down yards to store items until needed for new construction. In addition to construction facilities, procurement and materials management facilities are located in this area. N Area also contains some of the hazardous waste storage facilities for the site, which involves three primary operations: receipt of waste from onsite generators, interim storage, and shipment of the waste for offsite treatment and disposal. N Area is primarily comprised of heavy industrial, administrative, health and safety, and warehouse facilities. The warehouse facilities function to provide material coordination, material acquisition, and material processing for the entire site. Most N-Area facilities were originally constructed in the early 1950s and continue to provide adequate accommodations for their intended missions.

Area Hazards

N Area is positioned on a topographic and hydrogeologic divide; therefore, two conceptual site models for N-Area are provided in Figure

4.17b.1, *N-Area CSM for Fourmile Branch Watershed*, and 4.17b.2, *N-Area CSM for Pen Branch Watershed*, depicting the potential sources of contamination, migration pathways, exposure media and potential receptors. Table 4.3a, *Alternative Planned End State by Areas*, provides a listing of the N-Area waste units with associated characteristics. There are no major hazards in N Area that require remediation.

Area Cleanup Status

Table 4.3a, *Alternative Planned End State by Areas*, provides the current remedial status for the N-Area waste units and the remedial technology implemented for completed units. For waste units in the “to go” phase where the response action has not been selected, Table 4.4a, *Alternative Hazard Type Crosswalk for Area "To Go" Units*, depicts a crosswalk that categorizes each of the “to go” units” to a hazard type CSM located in Appendix K, *Conceptual Site Models for Typical Hazards*. The hazard type CSMs list the remedial technologies likely to be implemented for each hazard type. The “to go” waste units will undergo characterization, risk analysis, and evaluation for the appropriate remedial technologies.

Remediation for 13 of the 24 N-Area waste units is complete (Table 4.3). For the remaining 11 “to go” waste units, eight units are categorized as Hazard Type 5 (Nonradiological Rubble Piles and Pits), one unit as Hazard Type 6 (Nonradiological Seepage Basins), and two units as Hazard Type 9 (Miscellaneous Sites). Hazard sources to be evaluated for the remaining N-Area waste units include nonradioactive rubble and building debris, organic and inorganic constituents.

During waste unit investigations, evidence of sporadic and trace levels of organic groundwater concentrations have been observed. Further assessment/investigation is currently being

considered to determine whether or not this is a concern.

Area Planned End State Hazards

The current and projected end state for N-Area waste units is to accommodate a final risk level of 10^{-4} to 10^{-6} with institutional controls for the industrial worker.

Mission and Facility End State

N Area will remain active throughout the planning period as an industrial support area. This area would be used to consolidate maintenance activities near the center of the site, including excess warehousing operations and vehicle support maintenance from M Area. However, if there is no turnover to NNSA or major new missions, completion of the EM Closure Project will make most of the buildings and structures in N Area surplus, and any surplus building or structure will be demolished by 2025. Before any facilities are dispositioned, demolished, or in situ disposed, they will be evaluated per the CRMP for historic preservation and for the local economic outreach initiative.

Below is a table showing the number of nuclear, radiological and industrial facilities in N Area. End states are shown as either demolished or in situ. This information is based on the *SRS EM D&D Plan*, which did not account for reuse by other federal facilities or economic development or for historic preservation.

D&D has been initiated on a limited number of N Area buildings that have completed their mission. The majority of the facilities in this area will remain in service until the later portion of the EM mission.

N Area Totals			End State	
Facility Haz Type	No.	Sq Ft	DEM	ISD
Nuc	5	53,116	5	0
Rad	0	0	0	0
Oth Ind	78	864,111	78	0
Total	83	917,227	83	0

Table 4.14 N-Area D&D Table

NOTE: Information provided in this table is based on the *DOE/WSRC Contract No. DE-AC09-96R18500, Modification Number 100, and the Savannah River Site Environmental Management Integrated Deactivation and Decommissioning Plan, Rev. 1, September 30, 2003*. Current status is shown facilities completed as of the end of fiscal year 2003 (September 30, 2003).

4.4.13 P Area

Area Description

P Area is located in an upland area between Meyers Branch and Steel Creek approximately 2.5 miles east-southeast of the geographical center of SRS and about 4 miles west of the nearest site boundary. P-Area waste units are located in both the Steel Creek and the Lower Three Runs Watersheds.

P Area has been declared as an excess facility, and the current land use for P Area is site industrial.

Mission Description

P Area is one of five SRS reactor areas with the original mission of producing material for the Department of Defense nuclear weapons program. P Reactor is similar to other SRS reactors and has two functional areas, referred to as the exclusion area and the administrative area. The reactor exclusion area contains production buildings and facilities necessary for operational

support. The area surrounding the exclusion area contains the administrative support facilities and the cooling water storage basins. The entire reactor area, both exclusion and administrative areas, is enclosed by fencing to form an operations/administrative compound. P Area is permanently shut down with no future mission. P Area is primarily comprised of industrial, administrative, and some warehouse facilities. Most facilities were constructed in the early 1950s.

The disassembly area within the 105-P facility consists primarily of a water-filled basin with metal racks designed for vertical storage of fuel tubes and metal buckets for storing targets during operations. The basin contains several million gallons of water, and in the past it allowed the target and fuel assemblies to undergo natural radioactive decay after neutron irradiation. Currently, no irradiated or unirradiated fuel or targets are stored in the 105-P Disassembly Basin.

Area Hazards

P Area resides on a topographic and hydrogeologic divide; therefore, two conceptual site models for P-Area are provided in Figures 4.18b.1, *P-Area CSM for Lower Three Runs Watershed*, and 4.18b.2, *P-Area CSM for Steel Creek Watershed*, and depict the potential sources of contamination, migration pathways, exposure media and potential receptors. Table 4.3a, *Alternative Planned End State by Areas*, provides a listing of the P-Area waste units with associated characteristics. With the exception of G-Area waste units previously discussed with the appropriate watershed, the major hazards in P Area that require further evaluation and potential remediation are the P-Area Process Sewer Lines, P-Area Disassembly Basin, P-Reactor Seepage Basins, P-Reactor Discharge Canal, P-Reactor Area Cask Car Railroad Tracks and P-Reactor Groundwater.

Area Cleanup Status

Table 4.3a, *Alternative Planned End State by Areas*, provides the current remedial status for the P-Area waste units and the remedial technology implemented for completed units. For waste units in the “to go” phase where the response action has not been selected, Table 4.4a, *Alternative Hazard Type Crosswalk for Area "To Go" Units*, depicts a crosswalk that categorizes each of the “to go” units” to a hazard type CSM located in Appendix K, *Conceptual Site Models for Typical Hazards*. The hazard type CSMs list the remedial technologies likely to be implemented for each hazard type. The “to go” waste units will undergo characterization, risk analysis, and evaluation for the appropriate remedial technologies.

Remediation for 18 of the 30 P-Area waste units is complete (Table 4.3). For the remaining 12 “to go” waste units, six units are categorized as Hazard Type 2 (Radiological Seepage Basins and Pits), two units as Hazard Type 3 (Coal Pile Runoff Basins and Ash Basins), one unit as Hazard Type 4 (Inactive Process Sewer Lines), two units as Hazard Type 5 (Nonradiological Rubble Piles and Pits), and one unit as Hazard Type 10 (Groundwater). Hazard sources to be evaluated for the remaining P-Area waste units include radionuclides, nonradioactive rubble and building debris, organic and inorganic constituents.

Remedial technologies for groundwater are presented with each Hazard Type CSM in Appendix K, *Conceptual Site Models for Typical SRS Hazards (Soil, Groundwater, EM Facilities, and LRW Tanks)*. P-Area Groundwater is the only groundwater waste units in the “to go” phase. The groundwater pathways with impacted media and receptors are shown on Figures 4.18b.1, *P-Area CSM for Lower Three Runs Watershed* and 4.18b.2, *P-Area CSM for Steel Creek Watershed*. The source of the P-Area Groundwater OU is the P-Reactor Area.

Monitoring well data collected from the reactor area indicate the groundwater is contaminated with tritium, chlorinated VOCs, radionuclides, heavy metals and sulfate. Various former maintenance facilities in the P Reactor Area are the most likely contributors of the VOC contamination. P-Area groundwater with contaminants above MCLs has the potential to impact the Steel Creek IOU at the headwaters of Steel Creek and Meyers Branch. The groundwater investigation is entering the next phase to define the extent of the contaminant plumes, and results will be evaluated with regards to IOU impact in the next IOU periodic report.

Area Planned End State Hazards

The current and projected end state for P-Area waste units is to accommodate a final risk level of 10^{-4} to 10^{-6} with institutional controls for the industrial worker and below MCLs for groundwater.

Mission and Facility End State

By 2025 all hardened reactor facilities may be decommissioned by in-situ disposal and all non-hardened buildings and structures in P Area may be demolished. A perimeter fence will secure any remaining P Area facilities. Revised schedules and plans would be formulated if the facilities are turned over to a non-EM government entity, and the facility scope and lifecycle baseline plan changes.

Before any facilities are dispositioned, demolished, or in situ disposed, they will be evaluated per the CRMP for historic preservation and for local economic outreach initiative.

Below is a table showing the number of nuclear, radiological and industrial facilities in P Area. End states are shown as either demolished or in situ. This information is based on the *SRS EM D&D Plan*, which did not account for reuse by

other federal facilities or economic development or for historic preservation.

D&D has been initiated on the majority of the cooling water and support facilities in P Area. P Reactor will be the first complex hardened radioactive facility to undergo D&D to and in-situ disposal end state. Planning for development of this end state is in the initial stages.

P Area Totals			End State	
Facility Haz Type	No.	Sq Ft	DEM	ISD
Nuc	0	0	0	0
Rad	1	385,010	0	1
Oth Ind	19	272,911	11	8
Total	20	657,921	11	9

Table 4.15 P-Area D&D Table

NOTE: Information provided in this table is based on the *DOE/WSRC Contract No. DE-AC09-96R18500, Modification Number 100*, and the *Savannah River Site Environmental Management Integrated Deactivation and Decommissioning Plan, Rev. 1, September 30, 2003*. Current status is shown facilities completed as of the end of fiscal year 2003 (September 30, 2003).

4.4.14 R Area

Area Description

R Area is a 25.25 acres area located approximately 2.5 miles northeast of the geographical center of SRS. R-Area waste units are located in both the Lower Three Runs and Upper Three Runs Watersheds. In 1994, several of the support buildings including the silos were demolished and removed. The current land use for R Area is site industrial.

Mission Description

R Area is the oldest of the five SRS reactor areas with the original mission of producing material for the Department of Defense nuclear weapons program. The R-Area production reactor is permanently shutdown; however, the R Reactor building currently serves as a storage area for drums of depleted uranium. R Area is primarily comprised of nuclear industrial, administrative, and warehouse facilities. Most facilities were originally constructed in the early 1950s.

The disassembly area within the 105-R facility consists primarily of a water-filled basin with metal racks designed for vertical storage of fuel tubes and metal buckets for storing targets during operations. The basin contains about 4.5 million gallons of water and in the past the basin allowed target and fuel assemblies to undergo natural radioactive decay after neutron irradiation. Currently, no irradiated or unirradiated fuel or targets are stored in the 105-R Disassembly Basin. In the past 2 years the basin water has been processed in-situ to remove the majority of the cesium-137 and strontium-90 using innovative nuclide-specific ion-exchange technology.

Area Hazards

R Area resides on a topographic and hydrogeologic divide; therefore, two conceptual site models for the R Area are provided in Figure 4.19.b1, *R-Area CSM for Lower Three Runs Watershed*, and Figure 4.19b.2, *R-Area CSM for Upper Three Runs Watershed*, and depict the potential sources of contamination, migration pathways, exposure media and potential receptors. Table 4.3a, *Alternative Planned End State by Areas*, provides a listing of the R-Area waste units with associated characteristics. With the exception of G-Area waste units previously discussed with the appropriate watershed, the major hazards in R Area that require further evaluation and potential

remediation are the R- Area Process Sewer Lines, R-Area Disassembly Basin, the Old R-Area Discharge Canal, R-Area Reactor Disassembly Basin Release and R-Area Groundwater.

Area Cleanup Status

Table 4.3a, *Alternative Planned End State by Areas*, provides the current remedial status for the R-Area waste units and the remedial technology implemented for completed units. For waste units in the “to go” phase where the response action has not been selected, Table 4.4a, *Alternative Hazard Type Crosswalk for Area "To Go" Units*, depicts a crosswalk that categorizes each of the “to go” units” to a hazard type CSM located in Appendix K, *Conceptual Site Models for Typical Hazards*. The hazard type CSMs list the remedial technologies likely to be implemented for each hazard type. The “to go” waste units will undergo characterization, risk analysis, and evaluation for the appropriate remedial technologies.

Remediation for 10 of the 33 R-Area waste units is complete (Table 4.3). For the remaining 23 “to go” waste units, eight units are categorized as Hazard Type 2 (Radiological Seepage Basins and Pits), one unit as Hazard Type 3 (Coal Pile Runoff Basins and Ash Basins), two units as Hazard Type 4 (Inactive Process Sewer Lines), five units as Hazard Type 5 (Nonradiological Rubble Piles and Pits), six units as Hazard Type 9 (Miscellaneous Sites), and one unit as Hazard Type 10 (Groundwater). Hazard sources to be evaluated for the remaining R-Area waste units include radionuclides, nonradioactive rubble and building debris, organic and inorganic constituents.

Remedial technologies for groundwater are presented with each Hazard Type CSM in Appendix K, *Conceptual Site Models for Typical SRS Hazards (Soil, Groundwater, EM Facilities, LRW Tanks*. R-Area Groundwater and the R-

Reactor Seepage Basins are R-Area groundwater waste units in the “to go” phase. Groundwater beneath R Area has been contaminated by leaching of volatile organic compounds and radionuclides from area waste units above drinking water standards. The groundwater pathways with impacted media and receptors are shown on Figures 4.19b.1, *R-Area CSM for Lower Three Runs Watershed*, and 4.19b.2, *R-Area CSM for Upper Three Runs Watershed*. Groundwater characterization for R Area is ongoing and impacts to the Lower Three Runs Watershed have not been defined.

Area Planned End State Hazards

The current and projected end state for R-Area waste units is to accommodate a final risk level of 10^{-4} to 10^{-6} with institutional controls for the industrial worker and below MCLs for groundwater.

Mission and Facility End State

By 2025 all hardened reactor facilities may be decommissioned by in-situ disposal and all non-hardened buildings and structures in R Area may be demolished. A perimeter fence will secure any remaining R Area facilities. Revised schedules and plans would be formulated if the facilities are turned over to a non-EM government entity, and the facility scope and lifecycle baseline plan changes.

Before any facilities are dispositioned, demolished, or in situ disposed, they will be evaluated per the CRMP for historic preservation and for local economic outreach initiative.

Below is a table showing the number of nuclear, radiological and industrial facilities in R Area. End states are shown as either demolished or in situ. This information is based on the *SRS EM D&D Plan*, which did not account for reuse by other federal facilities or economic development or for historic preservation.

D&D has been initiated on the majority of the cooling water and support facilities in R Area. D&D of the R Reactor facility will follow the same process under development for P Reactor to achieve in-situ disposal end state.

R Area Totals			End State	
Facility Haz Type	No.	Sq Ft	DEM	ISD
Nuc	2	389,775	1	1
Rad	1	245	0	1
Oth Ind	8	409,707	0	8
Total	11	799,727	1	10

Table 4.16 R-Area D&D Table

NOTE: Information provided in this table is based on the *DOE/WSRC Contract No. DE-AC09-96R18500, Modification Number 100*, and the *Savannah River Site Environmental Management Integrated Deactivation and Decommissioning Plan, Rev. 1, September 30, 2003*. Current status is shown facilities completed as of the end of fiscal year 2003 (September 30, 2003).

4.4.15 S Area

Note: SRS plans to designate the area where SWPF and its supporting facilities will be built and operated as "J-Area". This area includes part of the existing S-Area and undesignated land between S-Area and H-Area. The planned facilities and processes identified in the S-Area section of this document encompass those that will be included in J Area.

Description

S-Area waste facilities are located in the Upper Three Runs Watershed. The current land use for S Area is site industrial.

Mission Description

All facilities located in this area are related to LRW immobilization and interim storage. Current facilities include DWPF, Glass Waste Storage Building (GWSB) Number1, Failed Equipment Storage Vaults, and other support structures (offices, maintenance shops, equipment/material storage, etc.).

DWPF receives pretreated, liquid radioactive waste from FTF and HTF and eventually from the various salt processing facilities and converts it, in a process called vitrification, to a stable form for safe long-term disposal. The vitrified waste is poured into stainless steel canisters that are then cooled, welded, and stored in the GWSB.

DWPF melters are operated until they fail. Failed melters are placed in specially designed storage boxes and temporarily stored in Failed Equipment Storage Vaults.

Area Hazards

The conceptual site model for S-Area is provided in Figure 4.20b, *S-Area CSM for Upper Three Runs Watershed*, and depicts the potential sources of contamination, migration pathways, exposure media and potential receptors. Table 4.3a, *Alternative Planned End State by Areas*, provides a listing of the S-Area waste units with associated characteristics. G-Area waste units were previously discussed with the appropriate watershed. There are no major hazards in S Area that require remediation.

Area Cleanup Status

Table 4.3a, *Alternative Planned End State by Areas*, provides the current remedial status for the S-Area waste units and the remedial technology implemented for completed units. Remediation is complete for all S-Area waste units.

Area Planned End State Hazards

The current end state for S-Area waste units accommodates a final risk level of 10^{-4} to 10^{-6} with institutional controls for the industrial worker.

Mission and Facility End State

DWPF and SWPF will be deactivated by isolating utilities and filling the canyon cells with grout. In addition, all waste transfer systems and the Failed Equipment Storage Vaults will be deactivated by isolating utilities and filling with grout. Both GWSB 1 & 2 will be deinventoried. The superstructure for each of these buildings will be removed, leaving the empty underground vaults with plugs in place.

S Area will be deactivated as prelude to in-situ disposal. The structural integrity of all waste transfer pipes and systems as well as storage vaults will be stabilized with grout. The superstructure surrounding the glass waste storage buildings will be removed, leaving the empty underground vaults with plugs in place. All other buildings and structures in S Area will be demolished as part of the EM Closure Project and a perimeter fence will secure any remaining S Area facilities.

Before any facilities are dispositioned, demolished, or in situ disposed, they will be evaluated per the CRMP for historic preservation and for the local economic outreach initiative.

Below is a table showing the number of nuclear, radiological and industrial facilities in S Area. End states are shown as either demolished or in situ. This information is based on the *SRS EM D&D Plan*, which did not account for reuse by other federal facilities or economic development or for historic preservation.

D&D will not be initiated in S Area until completion of waste processing in the later part of the EM Mission.

S Area Totals			End State	
Facility Haz Type	No.	Sq Ft	DEM	ISD
Nuc	17	383,157	15	2
Rad	1	225	1	0
Oth Ind	27	129,091	26	1
Total	45	512,473	42	3

Table 4.17 S-Area D&D Table

NOTE: Information provided in this table is based on the *DOE/WSRC Contract No. DE-AC09-96R18500, Modification Number 100*, and the *Savannah River Site Environmental Management Integrated Deactivation and Decommissioning Plan, Rev. 1, September 30, 2003*. Current status is shown facilities completed as of the end of fiscal year 2003 (September 30, 2003).

4.4.16 T AreaArea Description

The TNX Area is located 0.5 mile east of the Savannah River on an upland terrace between Upper Three Runs to the north and Fourmile Branch to the south. The site is at an elevation of 150 feet above mean sea level. Local topography is relatively flat with a slope toward the east away from the Savannah River. A portion of the Savannah River floodplain lies immediately west of the TNX Area at 95 feet above mean sea level. All T-Area waste facilities are located in the Savannah River/Floodplain Swamp Watershed. The current land use for T Area is site industrial.

The TNX Area contains facilities and buildings and waste units that are located outside of the fenced TNX Area. The TNX Burying Ground

(643-5G) was used to bury the remains of a 1953 accidental explosion of an experimental evaporator, which contained 544 kg (0.6 tons) of uranyl nitrate. The Old TNX Seepage Basin (904-76G) was in operation from 1951 through 1980. This facility was used to collect process wastewater, allowing settling of sediments in the small inlet basin and filtration through natural ion exchange media in the larger basin. Breaching the wall of the basin in 1980 released wastewater and sediments into the inner swamp, creating a delta of sediment that is now referred to as the Outfall Delta. The New TNX Seepage Basin (904-102G) replaced the Old TNX Seepage Basin after 1980.

Mission Description

This area was originally used as a staging area for receipt and testing of large process equipment destined for use in SRS production facilities. In the early 1950s, it was used to test the plutonium/uranium extraction (PUREX) process. Since that time, T Area, also known as the Multi-Purpose Pilot Plant Campus or TNX, has been utilized primarily as a pilot-scale test facility for SRNL. The most significant pilot-scale testing support has been for liquid radioactive waste initiatives, particularly DWPF. Since 1978, the area has expanded from three original buildings constructed in 1950 to 32 buildings currently located within the 14-acre fenced facility. The area is primarily comprised of light industrial, administrative, and warehouse facilities.

The Multi-Purpose Pilot Plant Campus buildings included administrative offices, process buildings for large-scale experimental demonstrations, laboratories for both research and analytical work, pilot scale facilities, bulk tank storage, industrial wastewater processing facilities, and warehouse storage for a wide range of chemical and specialty equipment. Located outside of the fenced area are additional facilities, including closed underground storage

tanks; the TNX Burying Ground and Seepage Basin, currently under evaluation by the ER Program; and the New TNX Seepage Basin.

The buildings are inactive and shut down with demolition either completed or underway in all but a few buildings. The SRS "Assets-for-Services" program has removed several buildings in T Area down to their foundation by trading the facility and its assets for decommissioning services.

Area Hazards

The conceptual site model for T-Area is provided in Figure 4.21b, *T-Area CSM for Savannah River/Floodplain Swamp Watershed*, and depicts the potential sources of contamination, migration pathways, exposure media and potential receptors. Table 4.3a, *Alternative Planned End State by Areas*, provides a listing of the T-Area waste units with associated characteristics. With the exception of G-Area waste units previously discussed with the appropriate watershed, the major hazards in T Area that require further evaluation and potential remediation are the Old TNX Seepage Basin, TNX Burying Ground, TNX Process Sewer Lines, and TNX Groundwater.

Area Cleanup Status

Table 4.3a, *Alternative Planned End State by Areas*, provides the current remedial status for the T-Area waste units and the remedial technology implemented for completed units. For waste units in the "to go" phase where the response action has not been selected, Table 4.4a, *Alternative Hazard Type Crosswalk for Area "To Go" Units*, depicts a crosswalk that categorizes each of the "to go" units to a hazard type CSM located in Appendix K, *Conceptual Site Model for Typical Hazards*. The hazard type CSMs list the remedial technologies likely to be implemented for each hazard type. The "to go" waste units will undergo characterization, risk

analysis, and evaluation for the appropriate remedial technologies.

Remediation for eight of the 17 T-Area waste units is complete (Table 4.3). For the remaining nine “to go” waste units, three units are categorized as Hazard Type 2 (Radiological Seepage Basins and Pits), two units as Hazard Type 4 (Inactive Process Sewer Lines), three units as Hazard Type 9 (Miscellaneous Sites), and one Hazard Type 10 (Groundwater). Hazard sources to be evaluated for the remaining T-Area waste units include radionuclides, nonradioactive rubble and building debris, radionuclides, organic and inorganic constituents.

Remedial technologies for groundwater are presented with each Hazard Type CSM in Appendix K, *Conceptual Site Models for Typical Hazards*. Groundwater in T Area is contaminated with carbon tetrachloride, PCE, and TCE above MCLs with a potential to discharge to surface water. TCE has been detected at the seep line in the Savannah River Swamp where the groundwater plume crops out. However, no constituents from the plume have been detected in the Savannah River or any offsite groundwater. Groundwater is also contaminated with chloroform above risk-based levels but does not exceed MCLs and therefore does not require action. There is also a small region of mercury contamination in the groundwater that generally exceeds the MCL with no discernable source. The groundwater pathways with impacted media and receptors are shown on Figure 4.21b, *T-Area CSM for Savannah River/Floodplain Swamp Watershed*. Groundwater characterization for T Area is ongoing and impacts to the Savannah River/Floodplain Swamp Watershed have not defined.

Area Planned End State Hazards

The current and projected end state for T-Area waste units is to accommodate a final risk level of 10^{-4} to 10^{-6} with institutional controls for the industrial worker and below MCLs for groundwater.

Mission and Facility End State

All buildings and structures in T Area will be demolished and any contamination of the soil and groundwater will be addressed. Below is a table showing the number of nuclear, radiological and industrial facilities in T Area. End states are shown as either demolished or in situ. This information is based on the *SRS EM D&D Plan*, which did not account for reuse by other federal facilities or economic development or for historic preservation.

D&D has been completed on all of the T Area facilities required to perform Area Closure.

T Area Totals			End State	
Facility Haz Type	No.	Sq Ft	DEM	ISD
Nuc	0	0	0	0
Rad	0	0	0	0
Oth Ind	29	161,732	29	0
Total	29	161,732	29	0

Table 4.18 T-Area D&D Table

NOTE: Information provided in this table is based on the *DOE/WSRC Contract No. DE-AC09-96R18500, Modification Number 100*, and the *Savannah River Site Environmental Management Integrated Deactivation and Decommissioning Plan*, Rev. 1, September 30, 2003. Current status is shown facilities completed as of the end of fiscal year 2003 (September 30, 2003).

4.4.17 Z Area

Mission Description

Z Area is composed of operating facilities used to treat and dispose of the low radioactivity salt solution resulting from various salt waste treatment processes, the concentrate from ETP and other low-level liquid waste streams. The area includes the Saltstone Production Facility and the Saltstone Disposal Facility (collectively referred to as the Saltstone Facility). Z Area is primarily comprised of light nuclear industrial, administrative, and warehouse facilities. Currently, the Saltstone Facility is being modified in preparation for restarting to process treated salt waste and accumulated feed from ETP. The Saltstone Production Facility blends a low radioactivity salt solution with cement, slag, and fly ash to create a grout mixture that hardens into a concrete-like material called saltstone. This plant works in conjunction with the Saltstone Disposal Facility, large concrete disposal vaults into which the grout solution prepared in the Saltstone Production Facility is pumped. After cells in the vault are filled, they are sealed with clean grout. Eventually, the vaults will be covered with soil, and a cap constructed of gravel, clay and other materials will be installed over the vaults to reduce rainwater infiltration and leaching of contaminants into the groundwater.

Area Hazards

The CSM for Z Area is provided in Figure 4.22b, *Z Area CSM for Upper Three Runs*. There are no waste units in Z Area.

Area Cleanup Status

Since there are no waste units in Z Area, there is no remediation ongoing or planned.

Mission and Facility End State

The Saltstone Production Facility will be closed by isolating process equipment and filling with grout where appropriate. All administrative facilities will have been deactivated and decommissioned, and above ground support systems, which present significant hazards, will have been removed. A perimeter fence will secure any remaining Z-Area facilities.

Before any facilities are dispositioned, demolished, or in situ disposed, they will be evaluated per the CRMP for historic preservation and for the local economic outreach initiative.

Below is a table showing the number of nuclear, radiological and industrial facilities in Z Area. End states are shown as either demolished or in situ. This information is based on the *SRS EM D&D Plan*, which did not account for reuse by other federal facilities or economic development or for historic preservation.

D&D will not be initiated in Z Area until completion of waste processing in the later part of the EM Mission.

Z Area Totals			End State	
Facility Haz Type	No.	Sq Ft	DEM	ISD
Nuc	4	191,102	2	2
Rad	0	0	0	0
Oth Ind	10	17,553	10	0
Total	14	208,655	12	2

Table 4.19 Z-Area D&D Table

NOTE: Information provided in this table is based on the DOE/WSRC Contract No. DE-AC09-96R18500, Modification Number 100, and the Savannah River Site Environmental Management Integrated Deactivation and Decommissioning Plan, Rev. 1, September 30,

July 26, 2005

2003. Current status is shown facilities
completed as of the end of fiscal year 2003

(September 30, 2003).

APPENDIX A
REGIONAL AND SITE MAPS

Map Number	Figure Name	Extent	Context
2.1	Regional Physical and Surface Interface - Current State (2003)	Regional	Physical & Surface
2.2	Regional Watershed Map - Current State (2003)	Regional	Watersheds
2.3	Regional Human and Ecological Land Use - Current State (2003)	Regional	Human & Ecological
3.1	Site Physical and Surface Interface - Current State (2003)	Site	Physical & Surface
3.2	Site Human and Ecological Land Use - Current State (2003)	Site	Human & Ecological
3.3	Site Legal Ownership - Current State (2003)	Site	Legal Ownership
3.4	Current Locations without Restrictions (2003)	Site	Watersheds
3.5	Future Development – Suitable for Industrial Missions	Site	Site Wide

Savannah River Site
2.1 - Regional Physical and Surface Interface - Current State

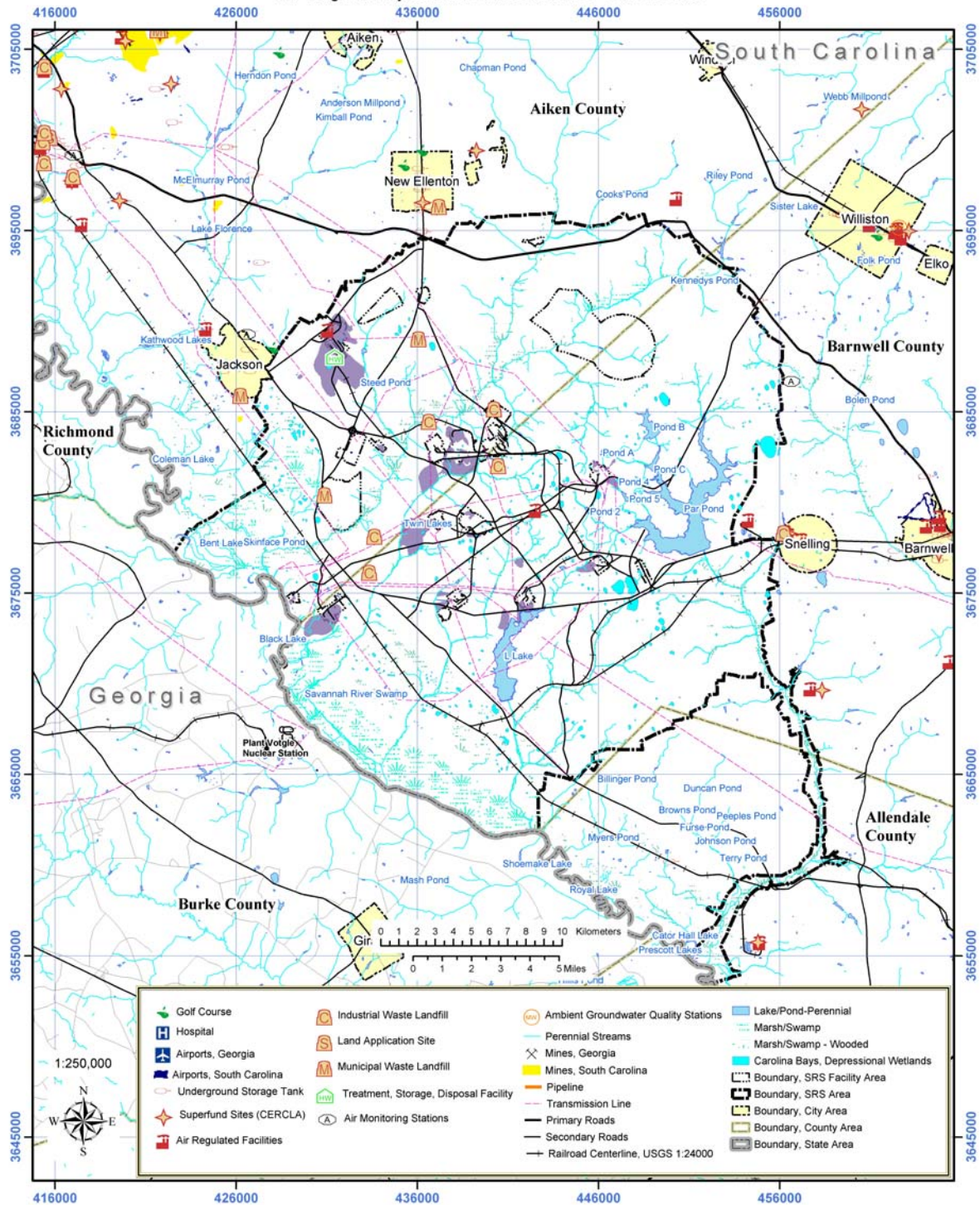

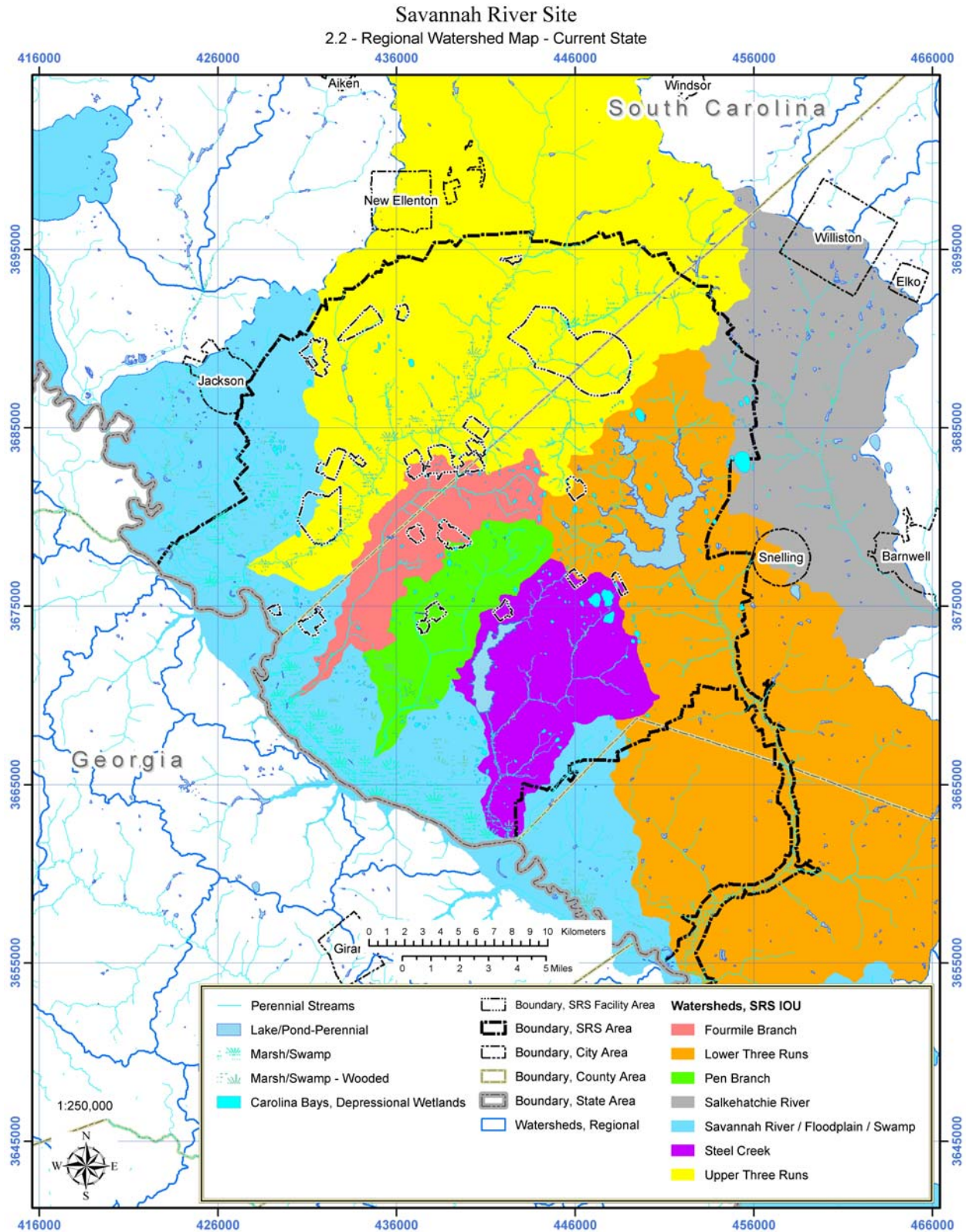

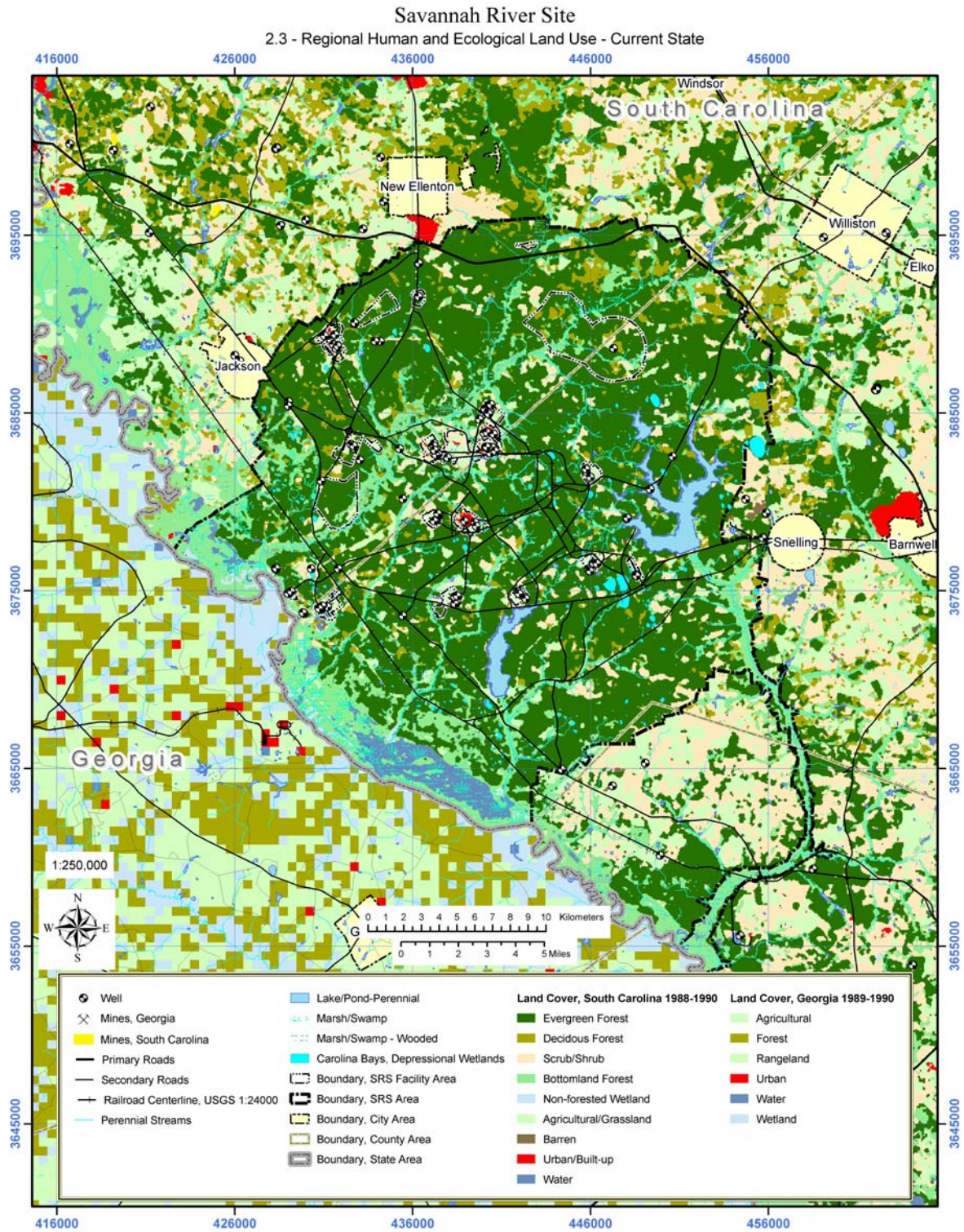

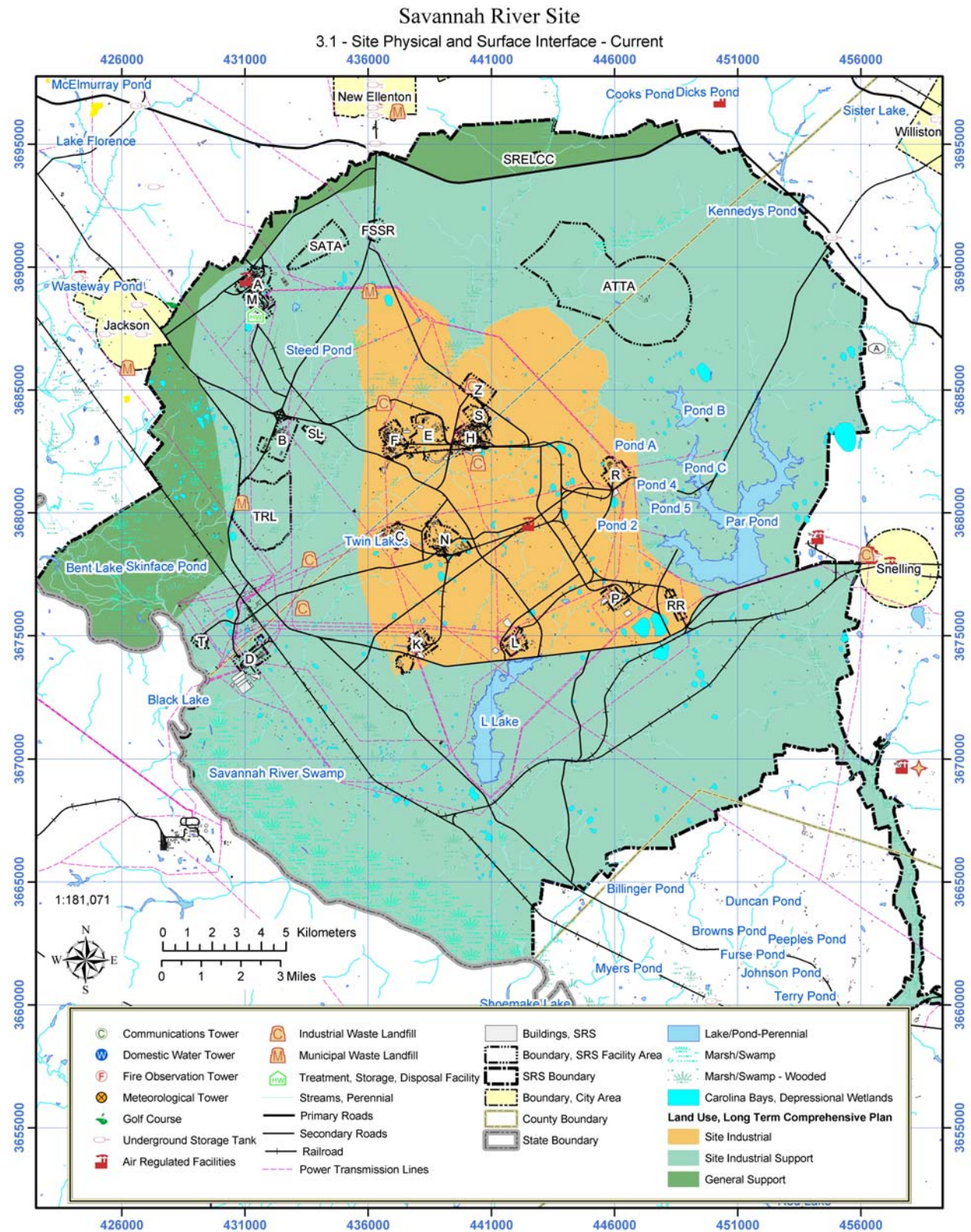

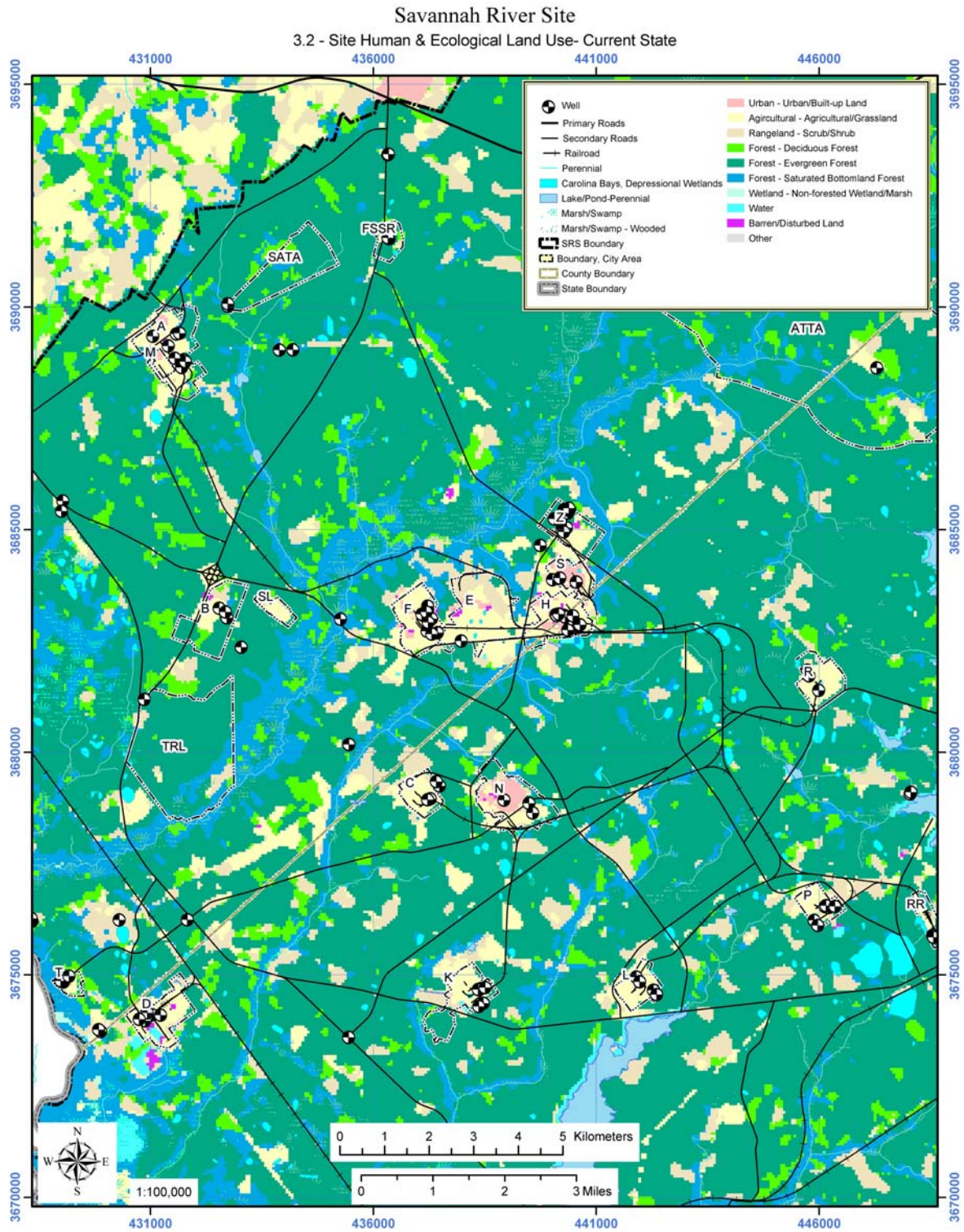

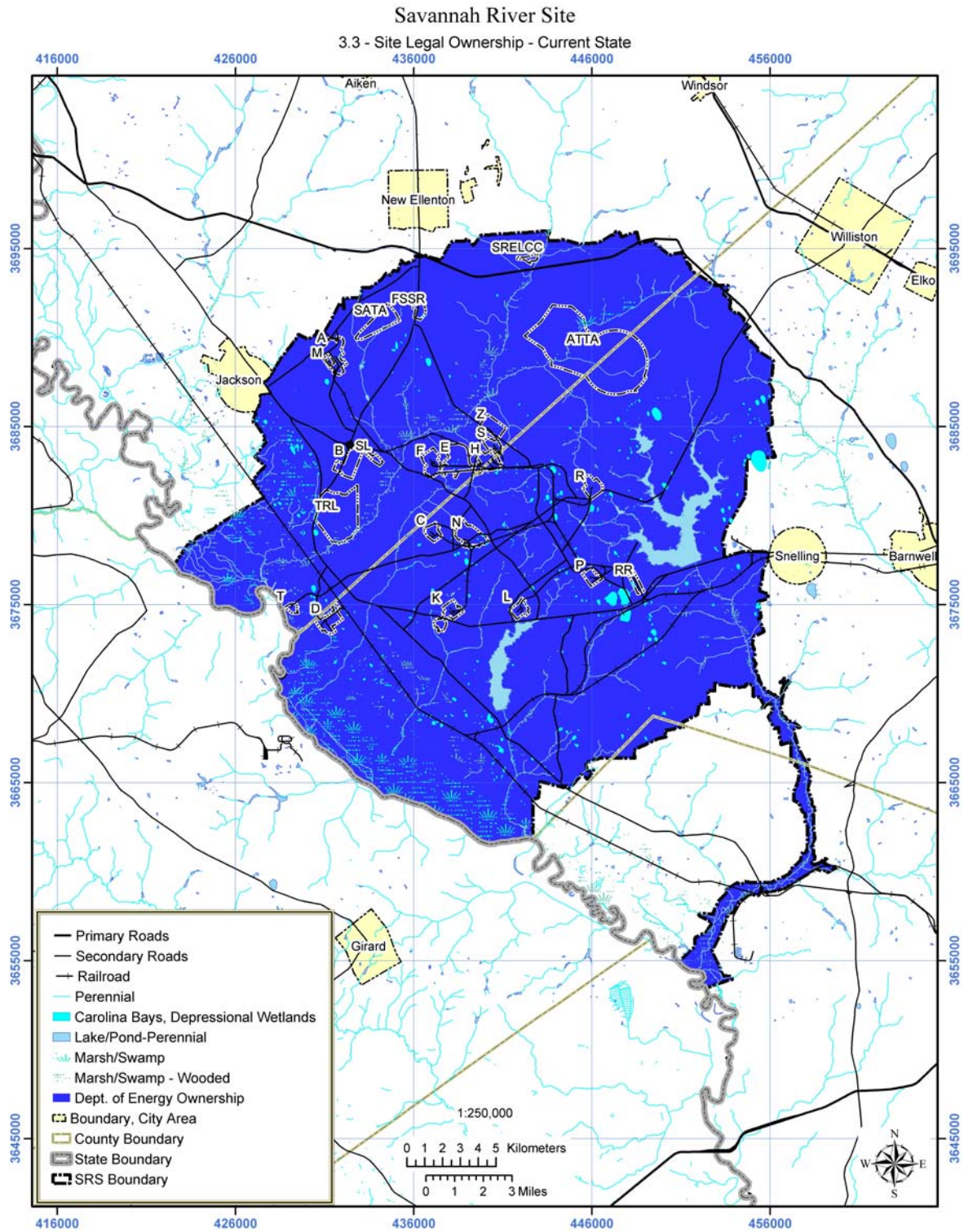

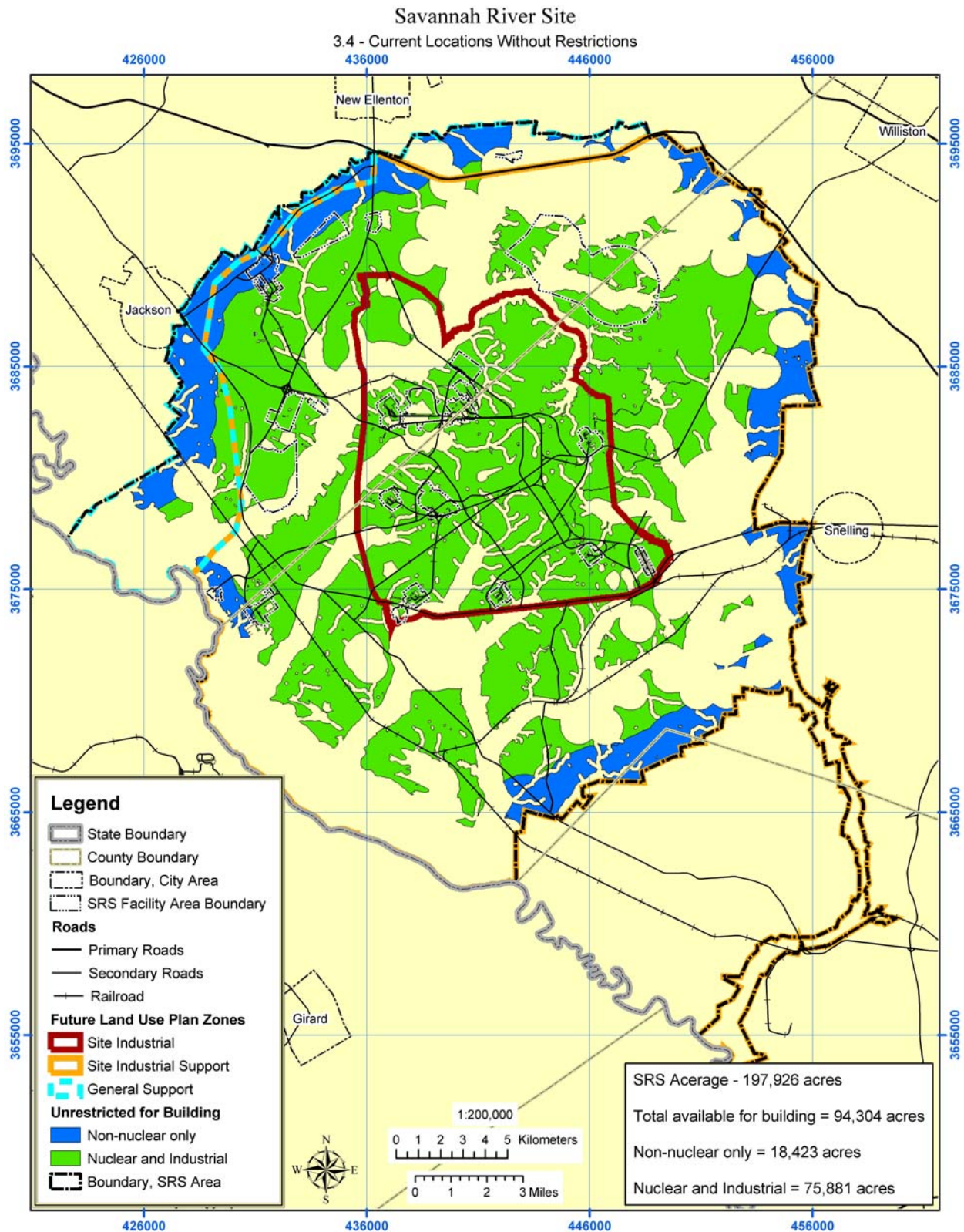

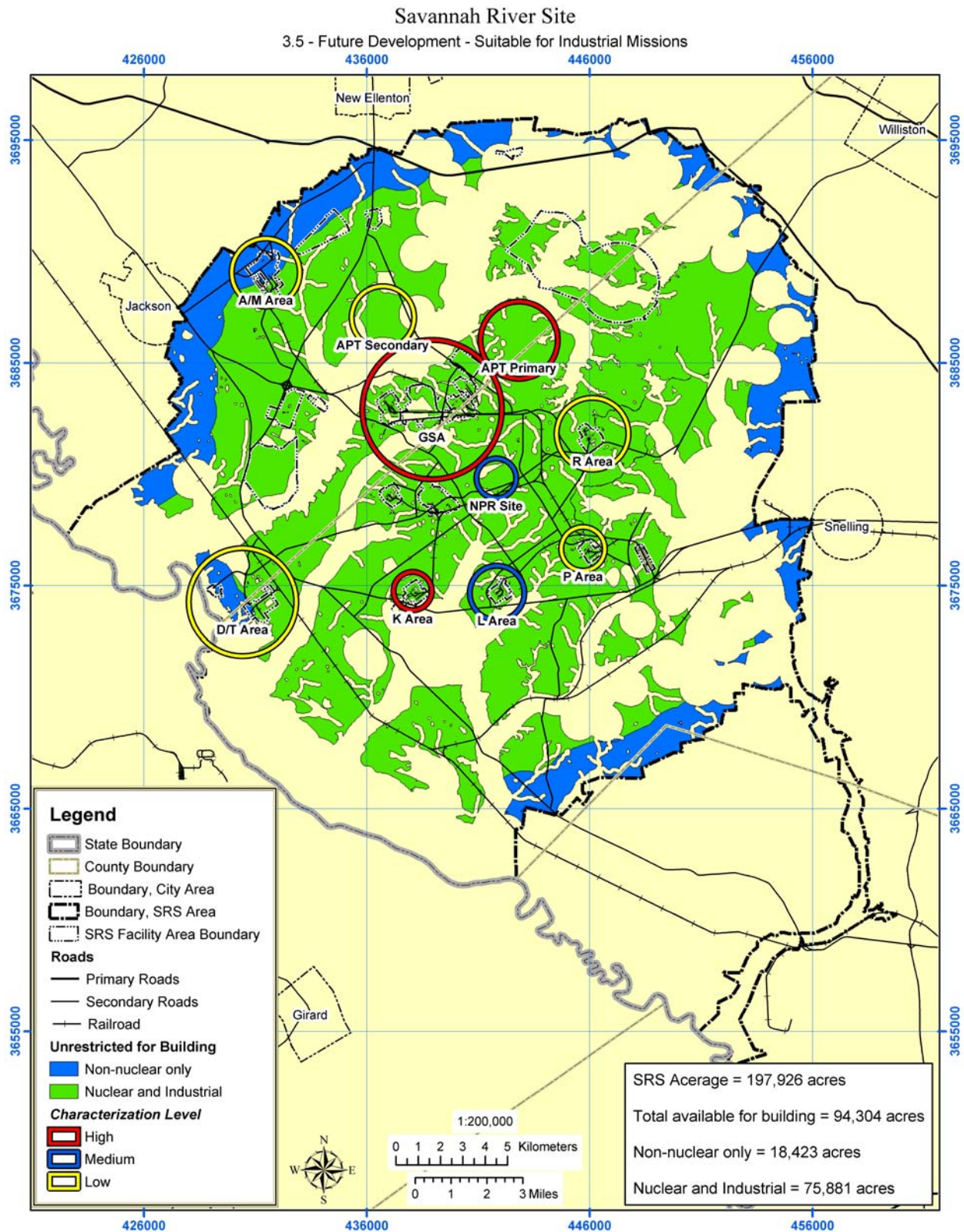

THIS PAGE INTENTIONALLY LEFT BLANK

APPENDIX B

ALTERNATIVE END STATES AND RECOMMENDATIONS

Alternative End State Definition and Application at SRS

The Savannah River Site (SRS) recommends four alternative end states with recommendations for implementation. The *SRS EM Performance Management Plan (PMP) Predecisional Draft* that was issued April 2004 is considered to be the SRS EM Cleanup project baseline. *For the purposes of this document, an alternative end state is defined as a significantly different cleanup approach or different end state relative to the SRS EM PMP.*

It is important to note that the proposed alternative end state and recommendations are considered to be “enablers” to accomplish the Environmental Management (EM) Cleanup Project by 2025 within the desired out year funding targets. Currently the SRS EM life-cycle baseline (technical scope, cost and schedule) is in the process of validation. After baseline validation, the alternative end states will be reassessed for changes to the EM Cleanup Project baseline.

The following alternative end states with associated implementation recommendations are submitted for consideration:

- Future Land Use and Exposure Scenario Modification
- Alternate Disposal for plutonium (Pu)-238 Contaminated Transuranic (TRU) Waste
- In Situ Decommissioning in lieu of Demolition
- Increased Liquid radioactive waste Defense Waste Processing Facility (DWPF) Canister Loading
- Area Completion

Total Risk Comparison for Alternative End States

- Alternative End State # 1: Future Land Use and Exposure Scenario Modification

The planned land use and exposure scenario—and, consequently, cleanup levels—for essentially all SRS areas is currently industrial. For many areas of SRS (see Alternate End State and Recommendation Table below), it is reasonable to anticipate that land use and exposure scenarios will be limited to infrequent maintenance activities (Alternate End State) as opposed to what would be expected in a typical industrial (Planned End State) land use scenario.

The total risk for the Alternative End State (AES) is less than Planned End State (PES). The resultant level of risk of both the AES (to a maintenance worker/receptor) and the PES (to an industrial worker/receptor) for Soil and Groundwater Project (SGP) waste units is essentially identical. The remaining “risk” (see explanation - Section 1.3, *Hazard and Risk Relationship*, in Chapter 1, *Introduction*) to a human receptor, regardless of receptor scenario, is assumed to fall within the 10^{-4} to 10^{-6} range with institutional controls. This “risk” is due to the exposure assumptions that factor into the assessment/calculation of receptor risk.

The largest factor that dictates the difference between the AES and PES is the amount of time an individual receptor is assumed to be exposed to contaminated material over a period of time. (See text box for generalized definitions for potential receptors.) The change in receptor (from industrial to maintenance) allows higher concentration(s) of contaminated material/media to remain while being equally protective of human health. This equates to a lower execution

risk (i.e., the hazard present while *achieving* the end state) for cleanup to maintenance levels, due to the fact that less (or no) remedial activity is needed to achieve levels protective of the maintenance worker. Thus the cleanup worker spends less time in the impacted area, and is less exposed to contaminated material.

Utilizing the approach as indicated in the schematic below, the AES, as proposed, would actually represent a decrease in total risk when considering the decrease in the execution risk as described in the preceding paragraph.

Future Industrial Worker

This scenario addresses long-term risks to workers who are exposed to unit-related constituents while working in an industrial setting. The future industrial worker is a person who works in an outdoor industrial setting that is in direct proximity to the contaminated media. EPA has established standard exposure assumptions that are utilized for the typical Future Industrial Worker scenario.

Maintenance Worker (Future)

The maintenance worker (future) is a receptor at an isolated, abandoned area that has not industrial or commercial activities planned for the future. The maintenance worker scenario addresses long-term risks to a receptor who may visit the abandoned area (i.e., having no future mission) on an infrequent or occasional basis. Maintenance activities, such as ant control, landscaping, site inspections, or perimeter security verification would make up the majority of the worker's time.

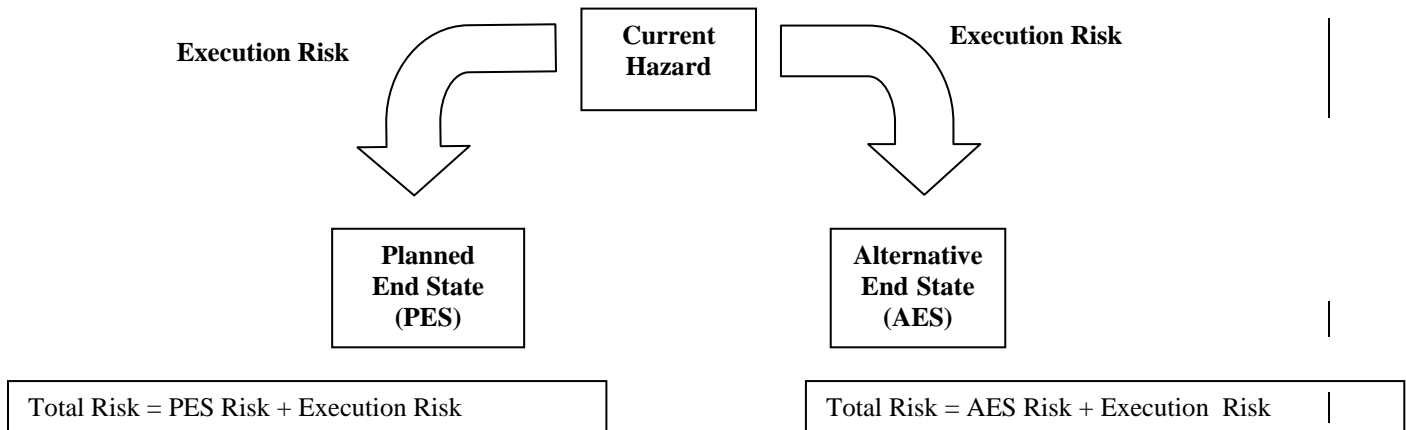

In order for the Department of Energy-Savannah River (DOE-SR) to attain the AES, two critical paradigm changes must occur. First, the regulatory community and the public must accept an atypical receptor scenario (maintenance worker) with corresponding input assumptions that represent realistic environmental conditions.

The Environmental Protection Agency (EPA) Office of Solid Waste and Emergency Response Directive No. 9355.7-04, *Land Use in the CERCLA Remedy Selection Process*, states that “reasonably anticipated future use of the land...is an important consideration in determining the appropriate extent of remediation. Future use of the land will affect the types...and frequencies of exposure that may occur, which in turn affects the nature of the remedy chosen.”

Second, DOE must make a commitment to control the respective SRS area in perpetuity, prohibiting industrial, as well as residential land use of said areas.

The Maintenance Worker exposure scenario, based on reasonable anticipation that an area will have no future industrial/commercial activities or use, must be mutually agreed upon by the DOE, South Carolina Department of Health and Environmental Control (SCDHEC) and EPA as representing a credible, sustainable end state. This agreement will be necessary for each individual area.

There is also a potential concern that relegating one or more areas of SRS to a “no future industrial use or mission” status (warranting a Maintenance Worker, rather than Industrial, future exposure assumption) will be perceived as condemnation of SRS property, reducing the overall attractiveness of SRS for potential new missions or redevelopment.

Map B.1 depicts the potential areas of SRS that may be candidates for Maintenance-Long Term Stewardship scenario as described by this alternative

Alternative End State # 2: Alternate Disposal for Pu-238 Contaminated TRU Waste

TRU waste contaminated with Pu-238 is planned to be characterized, repackaged, and shipped to the Waste Isolation Pilot Plant (WIPP). The Pu-238 is stored in many types of containers, including large steel boxes, other boxes, 55-gallon drums, and boxes and drums inside of concrete culverts. Some of the Pu-238 waste containers are under an earthen cover.

There are 1800 cubic meters of this waste, containing 300,000 curies. The contamination control of this material has been demonstrated to be difficult and will require modification of existing facilities or new facilities. The current shipping container (TRUPACT II) cannot ship these waste containers either due to size or high Pu-238 curie loading.

EPA regulation 40 *Code of Federal Regulations* (CFR) 191, *Environmental Radiation Protection Standards for Management and Disposal of Spent Nuclear Fuel, High-Level and Transuranic Radioactive Wastes*, and DOE Order 435.1, *Radioactive Waste Management*, allow disposal of TRU waste in a non-WIPP location and/or an exception to the definition of TRU waste. Waste, which DOE determines meets the EPA 40CFR191 performance objectives or that DOE and EPA determine does not need the degree of isolation required by the EPA regulation, can be disposed in a non-WIPP location.

Disposal at SRS of any small amount of Pu-238 waste would result in no significant impact to the public or the environment. Preliminary performance assessment calculations have shown that due to Pu-238's relatively short 88-

year half life, disposal at SRS would be protective of groundwater to EPA drinking water standards. Because Pu-238 has a short half life, uranium-234 becomes the contaminant of concern instead of Pu-238 from the radioactive decay process of the waste. Uranium-234 is not a transuranic isotope but is a common radioactive isotope in low-level waste that is disposed safely at SRS and other LLW disposal facilities across the country. Therefore, a performance assessment of near-surface disposal would show that groundwater, intruder, and public protection standards can be met.

Near-surface disposal would also avoid a significant worker exposure concern from repackaging the waste to meet stringent waste acceptance criteria for disposal at WIPP. Also, an estimated \$180 million cost savings would be realized by disposal onsite versus building a unique, expensive facility to characterize and repackage the Pu-238 waste for shipment to WIPP (not including the disposal costs at WIPP).

The contamination control of Pu-238 material has been demonstrated to be difficult and will require modification of existing facilities or new facilities. Some of the Pu-238 waste is very high in Pu-238 oxide content and is stored in inner containers that have suspect integrity. (The outer concrete culverts/steel boxes ensure safe storage.) In order to ship this waste to WIPP, many of the containers would have to be opened in order to repackage the waste to meet transportation requirements and to remove WIPP-prohibited items. Existing facilities are not adequate to protect SRS workers from potential releases from the containers with the highest Pu-238 concentrations. Very costly new facilities or modifications to existing facilities would be required.

With the potential of not having the required facilities to allow workers to handle the waste and with the resulting increased exposure of

workers handling the waste, an alternative—on-site disposal—will eliminate significant worker risk. The preliminary estimates of 1800 cubic meters of Pu-238 waste not shippable to WIPP are bounding estimates to ensure performance assessment calculations are conservative. The actual volume of Pu-238 waste that may be evaluated for this alternative end state will likely be far less.

The expected concept for disposal is to entomb the Pu-238 waste in a concrete monolith that would ensure risk mitigation through meeting the performance objectives for thousands of years. In fact the preliminary calculations have shown that the maximum concentration of Pu-238 in the groundwater over a period of 10,000 years would be very close to zero and the dose to the inadvertent intruder would be less than 20 percent of the regulatory limit. A full and complete performance assessment of the disposal design would be required along with independent technical reviews from a national panel should DOE decide to pursue this alternative, and stakeholders will have an opportunity to review the assumptions and analyses supporting it.

Any additional evaluation of this alternative would first require the removal of the earthen cover on TRU Pad 1 to determine the integrity of the waste containers and the ability to handle the waste. It is expected that the TRU Pad 1 waste will contain the most difficult Pu-238 waste to repackage for shipment to WIPP and the waste most probably appropriate for this alternative.

- Alternative End State #3: In-situ Decommissioning in lieu of Demolition

The 2002 *EM PMP* end states were the “baseline” against which to evaluate potential alternative end states. In that *PMP*, the planned end state for SRS reactor buildings, chemical separations facilities (canyons), and other

hardened structures was deactivation and long-term surveillance and maintenance.

Since then SRS has planned and is executing a plan that takes all EM facilities to a final decommissioning end state of either demolition or in situ disposal. This approach reduces the long-term surveillance and maintenance that was envisioned by the *2002 EM PMP*. In situ disposal may be selected for a variety of facilities, ranging from hardened, contaminated nuclear facilities to non-contaminated water treatment facilities.

For each facility slated for in-situ disposal, it must also be demonstrated that the hazards have been removed or immobilized such that the remaining risk levels following in situ disposition are acceptable.

One or more facilities will be decommissioned in situ in all SRS areas except for A, M, N, and T Areas.

The first major facility scheduled for in situ disposal is P Reactor to support P-Area Closure in FY 2013. In preparation for that project, appropriate end state alternatives that are protective, reasonable, compliant with appropriate regulations, and consistent with the planned future use and end state for its area will be developed for evaluation

Since the EM PMP and planned end state condition for these facilities is now “in-situ disposal,” it is no longer an alternative end state warranting a comparison to an existing plan.

This alternative end state will not be retained in this form for evaluation in any future versions of the *SRS End State Vision*, since it merely describes what is now the planned end state for the selected locations such as the reactors, canyons, and hardened facilities.

- Alternative End State # 4: Increased Liquid radioactive waste DWPF Canister Loading

The *2002 EM PMP* assumed that 6000 canisters of liquid radioactive waste would have to be made to complete the mission of the Defense Waste Processing Facility (DWPF). Increasing the amount of liquid radioactive waste that could be vitrified in each canister was identified in the March 2004 *Risk-Based End State Vision* for the Savannah River Site as a “variance,” or alternative to the 2002 PMP end state.

The *2004 EM PMP*, however, already incorporates significantly increased waste loading in each canister, as a result of system engineering enhancements, reducing the estimated total number now to be 5060 canisters. Therefore, this previously identified variance is now a planned end state and no comparison to the original (2002 PMP) end state is warranted.

Technical factors, including the durability of the glass formed in the vitrification process at DWPF, limit the waste content of each canister. Work continues to overcome these technical limitations so that more waste can be included in each canister produced, resulting in fewer canisters needing to be filled, stored on SRS, and ultimately shipped to the federal repository, with commensurate reductions in worker and transportation risks.

This alternative end state will not be retained for evaluation in any future versions of the *SRS End State Vision*, since it merely describes what the standard mode for canister loading at SRS is now.

- Alternative #5 Area Completion

SRS had provided Alternative #5 as a component of Variance #2 in the March 2004 *Risk-Based End State Vision*. SRS decided to eliminate the methodology in the March 2005 End State Vision submittal due to the successful incorporation and implementation of the methodology as the standard or routine approach to environmental restoration activities at SRS. It

is being reinstated in this version to recognize:

- 1) that SRS has instituted Area Completion as the primary component of its Federal Facility Agreement (FFA) (see Section 1.5.1, *Clean Up Accomplished* in Chapter 1, *Introduction*); and
- 2) that cleanup efficiencies and effectiveness are realized as a result of its implementation.

In the past, SRS addressed all inactive waste units and EM facilities hazards on an individual basis; that is, each waste unit and/or EM facility is characterized, assessed, and remediated as a single entity. There are at least twelve major heavy industrial areas at SRS. The industrial areas are generally fenced and contain buildings, pipelines, roads, railroads, and other industrial infrastructure. The areas generally range in size from tens to hundreds of acres. These areas contain numerous waste units and facilities slated for decommissioning. There are obvious advantages in addressing the area as a whole, performing characterization and assessments collectively, potentially remediating groups of

hazards at one time, and integrating the closure of D&D facilities in conjunction with Soil and Groundwater Project facilities with subsequent deletion of substantial acreage from the National Priorities List. The three FFA parties are in the process of negotiating the details on the methodology to accomplish this and have called the approach the Area Completion. It is anticipated the modified exposure scenario presented in the Exposure Scenario Modification subsection (Alternative #1) will be applied to entire areas as well as for individual hazards, dependent upon future land use or mission. All SRS process/industrial areas are to be evaluated for Area Completion.

As a result of three party acceptance of the 2005 FFA Appendix E, which institutes the Area Completion approach to all of the heavy industrial areas at SRS; it is no longer an alternative end state warranting a comparison to an existing planned end state. That is, Area Completion is now SRS's Planned End State.

Alternative end states and Recommendations				
ID No.	Description of Alternative End State	Impacts (in Terms of Scope, Cost, Schedule & Risk)	Barriers in Achieving End State Vision	Recommendations
1	<p>Alternative End State: Future Land Use and Exposure Scenario Modification. Proposed Future Land Use and associated receptor exposure scenario is Maintenance – Long Term Stewardship for previous industrial operations areas with no planned industrial reuse.</p> <p>(Current Planned End State/Future Land Use is Industrial with no Residential Land Use. Risk determination for Human receptors assumes an Industrial worker exposure scenario.)</p>	<p>Scope: Exposure Scenario Modification. SRS is currently in discussions with EPA Region IV and SCDHEC to establish and apply more appropriate exposure scenarios for selected areas of the site that are not planned to support any future mission. Justification for this modified receptor is that due to the lack of a mission, a maintenance worker or long-term stewardship worker will spend significantly less time at the unit, or in the area, than the day to day industrial worker. This modified exposure scenario will afford the three parties of the Federal Facility Agreement (DOE, EPA, DHEC) less conservative, yet realistic, input parameters that are utilized to calculate risk, based on the hazards present. Therefore, the end state calculated cancer risk will remain consistent between current/planned and vision approaches (<math>10^{-6}</math> residential and <math>10^{-4}</math> to <math>10^{-6}</math> worker with institutional controls); the change will be realized in the receptor specific inputs for the type of worker needed for the mission associated with the unit and/or area (e.g., industrial worker exposure = 2000 hrs/yr, while a maintenance/long term stewardship worker realizes 200 hrs/yr of exposure). It is assumed the scenario most likely to be applied for specific SRS facilities and/or areas without future missions will equate to an order of magnitude risk change that will be less conservative (i.e., if current industrial worker cancer risk calculates a <math>10^{-4}</math> risk, then the vision maintenance worker risk will calculate a <math>10^{-5}</math> risk).</p> <p><i>Note: The Maintenance/Long-Term Stewardship exposure scenario described above (200 hours/year) is for illustration only. The actual</i></p>	<p>Regulatory Acceptance. Approach deviates from routine/typical regulatory accepted methodology/protocol for evaluating risk.</p> <p>Land Use. Lack of binding/promulgated DOE land use policy for site.</p>	<p>Public and other stakeholders recommend Congressional Authorization to ensure perpetual federal ownership and LTS responsibility for SRS's fixed boundaries.</p>

Alternative end states and Recommendations				
ID No.	Description of Alternative End State	Impacts (in Terms of Scope, Cost, Schedule & Risk)	Barriers in Achieving End State Vision	Recommendations
		<p><i>exposure parameters for this estimating risk to this hypothetical receptor would be negotiated by DOE, SCDHEC, and EPA.</i></p> <p>Current and Current Future Land Use is Industrial with No Residential Land Use.</p> <p>Alternative end state proposes to revise Future Land Use as follows:</p> <ul style="list-style-type: none"> • Continue Industrial: A,B,E-part, F-part, G, H, M, and N • Maintenance-LTS: T,D,C, F-part, E-part, H-part, K,L,P,R,S,Z • For facilities and/or resources that will be preserved and maintained as cultural resources as defined by the National Historic Preservation Act, appropriate land use and exposure scenarios will be negotiated that will accommodate any activities associated with these respective facilities/resources. 		

July 26, 2005

B.1 - Alternative End State No. 1

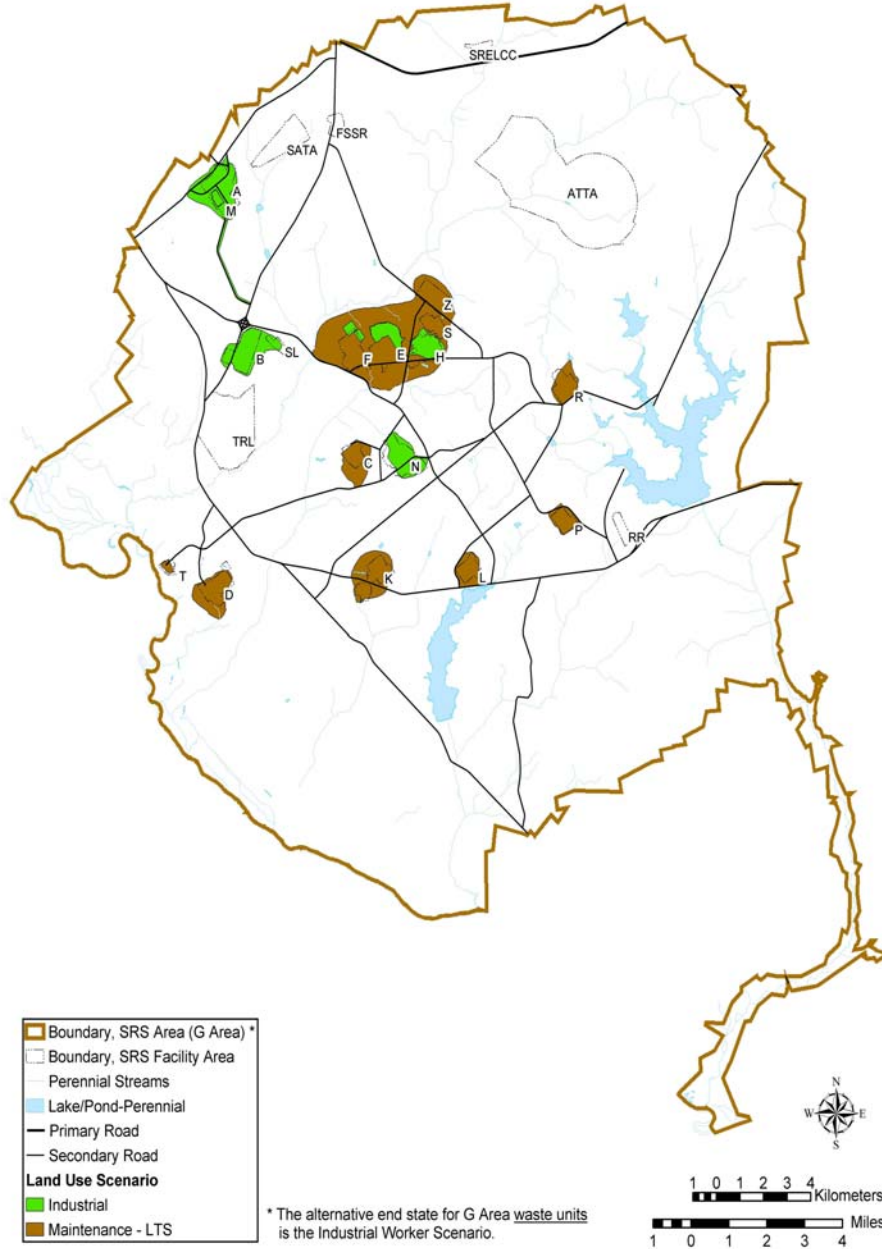

Alternative end states and Recommendations				
ID No.	Description of Alternative End State	Impacts (in Terms of Scope, Cost, Schedule & Risk)	Barriers in Achieving End State Vision	Recommendations
2	Alternative End State: Alternate Disposal for Pu-238 TRU Contaminated Waste	<p>Scope: TRU waste contaminated with Pu-238 is planned to be characterized, repackaged, and shipped to WIPP. The Pu-238 is stored in many types of containers including large steel boxes, other boxes, 55 gallon drums, and boxes and drums inside of concrete culverts. Some of the Pu-238 waste is under soil cover. There are 1800 cubic meters containing 300,000 curies (0.3 million). The contamination control when opening containers with high concentrations of this material has been demonstrated to be difficult and will require modification of existing facilities or new facilities. The current shipping container (TRUPACT II) cannot ship these waste containers either due to size or high Pu-238 curie loading.</p> <p>The WIPP Land Withdrawal Act, EPA regulation 40CFR191 and DOE Order 435.1 allows an exception to the definition of TRU waste. Waste that DOE and EPA have determined does not need the degree of isolation required by the EPA regulation. The determination is based on an evaluation of a disposal concept including a performance assessment to demonstrate protection of human health and the environment. Through a Performance Assessment of near surface disposal it can be shown that groundwater protection, intruder, and public protection standards can be met. Disposal in near surface disposal would avoid a significant worker exposure issue because containers would not need to be opened. Also an ~ \$180M total potential cost savings to EM (\$48M to SRS EM) would be realized by disposal onsite vs. characterization, repackaging, and shipment to WIPP (not including the disposal costs at WIPP).</p>	<p>Political barrier of State of SC willingness to allow disposal of additional 300,000 curies of Pu (thousands, however, not millions). Most of this would be mixed waste. SCDHEC has regulatory authority over the mixed waste and their approval would be required to remove mixed waste labels based on SRS process knowledge justification. SCDHEC does not have regulatory authority over the portion that is not labeled as mixed.</p>	<p>As TRU program moves toward completion, TRU not containing Pu-238 will be shipped to WIPP.</p> <p>This alternative for TRU containing Pu-238 will be evaluated in FY 2009, after the rest of the TRU has been dispositioned.</p>

Alternative end states and Recommendations				
ID No.	Description Of Alternative End State	Impacts (in Terms of Scope, Cost, Schedule & Risk)	Barriers in Achieving End State Vision	Recommendations
3	Alternative End State: In Situ Decommissioning in lieu of Demolition	<p>Scope: The 8-7-02 <i>SRS EM PMP</i> stops at deactivation for the Reactor and Canyon facilities and does not address decommissioning (demolition or in situ disposal) as a final end state for the Reactor and Canyon facilities.</p> <p>Planned End State now includes decommissioning and in situ disposal for the Reactor and Canyon facilities. In Situ decommissioning is ~50% less costly than demolition and risk assessments will identify this as a lower overall risk.</p>	Exact end state condition for in-situ decommissioning needs better definition through technical evaluation of alternatives.	<p>Further study will inform this end state.</p> <p>Not retained for evaluation in future version of the <i>SRS End State Vision</i>.</p>
4	Alternative End State: Increased Liquid Radioactive Waste DWPF Canister Loading	<p>Scope: 2002 <i>EM PMP</i> assumed that 6000 LRW canisters would have to be produced at DWPF to complete the LRW mission at SRS. In the 2004 <i>EM PMP</i>, the assumed canister loading had already increased significantly through LRW system engineering improvements.</p> <p>Will not be retained as an Alternative End State in the Final SRS <i>ESV</i>, since higher canister loading has already been realized.</p>	Further increases in canister loading are limited by technical factors such as the durability of the glass when higher amounts of waste are present.	<p>Continue research and testing to improve glass durability, making further increases in canister loading possible.</p> <p>Not retained for evaluation in future versions of the <i>SRS End State Vision</i>.</p>

Alternative end states and Recommendations				
ID No.	Description Of Alternative End State	Impacts (in Terms of Scope, Cost, Schedule & Risk)	Barriers in Achieving End State Vision	Recommendations
5	Area Completion	<p>Scope: In the past, SRS addressed all inactive waste units and EM facilities hazards on an individual basis; that is, each waste unit and/or EM facility is characterized, assessed, and remediated as a single entity. There are at least twelve major heavy industrial areas at SRS. The industrial areas are generally fenced and contain buildings, pipelines, roads, railroads, and other industrial infrastructure. These areas contain numerous waste units and facilities slated for decommissioning. There are obvious advantages in addressing the area as a whole, performing characterization and assessments collectively, potentially remediating groups of hazards at one time, and integrating the closure of D&D facilities in conjunction with Soil and Groundwater Project facilities with subsequent deletion of substantial acreage from the National Priorities List.</p>	<p>None. DOE, EPA, and SCDHEC are in the process of negotiating the details on the methodology to accomplish this and have called the approach the Area Completion.</p>	<p>As a result of three party acceptance of the 2005 FFA Appendix E which institutes the Area Completion approach to all of the heavy industrial areas at SRS; it is no longer an alternative end state warranting a comparison to an existing planned end state. That is, Area Completion is now SRS's planned end state.</p>

APPENDIX C

REGIONAL PLANNING INITIATIVES

Throughout the last ten years SRS has maintained a close relationship with planning groups, local governments, Council of Governments (COGs) and economic development organizations. Site planners have been active in sharing plans and planning techniques, providing tours and information – and local planners have reciprocated. This close interaction has produced strong cooperation, which has resulted in site and regional planners being current on each other's plans. This has eliminated the need for extensive education whenever new plans are created.

The following is a list of planning organizations contacted for the *SRS End State Vision*:

South Carolina

- Aiken County Planning Department
- Aiken-Edgefield Economic Development Partnership
- City of Aiken Planning Department
- Lower Savannah Council of Governments (Responsible for planning for six counties in South Carolina – all within 70 miles of SRS - Aiken, Allendale, Bamberg, Barnwell, Calhoun, and Orangeburg Counties)
- North Augusta Department of Economic Development
- The Southern Carolina Regional Development Alliance (Allendale, Barnwell Bamberg and Hampton Counties)

Georgia

- Augusta-Metro Chamber of Commerce (Includes Columbia and Burke Counties)
- Augusta-Richmond County Planning Department
- Central Savannah River Area Regional Development Center (supports 14 Georgia counties in the region – including those in the SRS vicinity – Augusta-Richmond, Burke and Columbia)
- Columbia County Planning Department

Based on discussions and review of draft and final growth management, transportation and economic development plans in the region, it is reasonable to conclude that there are no major changes that would affect site missions in the next 20 years. While normal growth is expected in metropolitan counties in the region or populated regions of counties around SRS, the predominate land uses in the areas adjacent to SRS are expected to remain the same. The current major land uses on the border with SRS include:

- ♦ Agriculture – While some livestock, horse farming and vegetable farming takes place, most of the land is used to produce forest products (for pulp and paper, telephone poles, pine straw).
- ♦ Light industry - There is currently one 1,500 acre industrial park adjacent to SRS. Bordering this industrial center is the Chem-Nuclear Systems Low Level Radioactive Waste Disposal Facility, owned by Duratek. Also in close proximity is Plant Vogtle, a nuclear power facility, directly across the Savannah River from SRS. The Three Rivers Landfill is operating onsite under the authority of a fifty-year lease administered by the Lower Savannah Council of Governments.
- ♦ Light residential – Most of housing on this land is associated with agriculture; however, some houses and manufactured homes border the site.
- ♦ Recreation – Because over 90% of SRS is not used for industrial purposes wildlife is plentiful. Because of this, extensive outdoor sports activities take place next to SRS. These activities include hunting, fishing, hiking and bird watching.

THIS PAGE INTENTIONALLY LEFT BLANK

APPENDIX D
REGULATORY SUPPORT AND AGREEMENTS

THIS PAGE INTENTIONALLY LEFT BLANK



Memorandum of Agreement for Achieving an Accelerated Cleanup Vision Savannah River Site

On May 22, 2003, the Department of Energy -Savannah River Operations Office (SR), the U.S. Environmental Protection Agency-Region 4 (US EPA) and the South Carolina Department of Health and Environmental Control (SCDHEC), known hereafter as “the Parties,” agreed to support accelerated cleanup of the Savannah River Site (SRS). Building on this Letter of Support, the Parties hereby agree to the following implementing principles and concepts.

1. The Parties are committed to work together to develop a Comprehensive Cleanup Plan (CCP) to achieve an earlier end date for the environmental restoration and facility decommissioning at SRS. The CCP will represent an accelerated cleanup program that has a clear objective to reduce risks to workers, the public and the environment. For the purposes of the environmental restoration program, the CCP will become the basis to the Federal Facility Agreement (FFA) Appendices D and E and their annual submissions. The CCP will demonstrate the SR’s commitment to maintain a level of cleanup work consistent with the intent of the letter from V. L. Weeks, US EPA, to L. C. Goidell, SR, dated August 16, 1993, Subject: Fiscal Year 1993 Through 2006 Commitments, Federal Facility Agreement.
2. The Parties agree that the CCP will support the Target and Vision cleanup objectives, which are closing whole areas earlier, leading to earlier completion of the entire cleanup program. This Memorandum of Agreement (MOA) sets forth principles for accelerating SRS cleanup, beyond the objectives of the SRS Environmental Management Program Performance Management Plan (PMP). SRS will reduce its operations footprint to establish a buffer zone at the perimeter of the Site, while the central area of the Site will be reserved for continuing or future long-term operations. The Parties agree that establishing this buffer zone and appropriately sequencing environmental restoration and decommissioning activities can lead to early closure of areas. This will enable the Parties to prioritize areas for closure and determine areas of the SRS that will be candidates for deletion from the National Priorities List (NPL).

**Memorandum of Agreement for Achieving an
Accelerated Cleanup Vision
Savannah River Site**

3. The completion of the SRS environmental cleanup program will be achieved through the completion of areas within watersheds, followed by the Integrator Operable Units (IOUs), and concluding with the Savannah River and Flood Plain Swamp IOU. The principle of area closure is to determine that areas are completed when all required response actions are completed. The specific site area scoping assumptions will be established by the respective core team, in support of the CCP development. As an area is completed, the Parties endorse the application for partial deletion of the respective area from the NPL. The goal is to delete all areas of the SRS from the NPL, as depicted in the attached conceptual chart (Attachment 1).
4. Decommissioning will be conducted consistent with the attached administrative flow path, which demonstrates integration with the FFA process (Attachment 2).
5. The completion of an area will be documented in an Area Record of Decision (ROD) as described in item 3 above. To achieve Area RODs, decommissioning and environmental restoration work will be sequenced and conducted such that the Area ROD schedules will be met. Annually, SRS will provide a decommissioning schedule that supports meeting the Area ROD schedule.
6. The Parties agree that the concept of Area RODs is an appropriate tool for the re-sequencing of the FFA program to support area closure as the accelerated end date is being achieved. To the maximum extent practicable, entire areas of the SRS (e.g., a facility area such as TNX) will be addressed as a consolidated unit to take advantage of characterization data, risk assessment, and integrated solutions that consolidate areas into an expanded operable unit to effect economies of scale and reduce administrative requirements.
7. The Parties recognize that to effect an accelerated end date for the program, individual operable units or aggregations of operable units that comprise the program will need to be assessed and the remedies selected and implemented in an expeditious manner.
8. To reduce the time to assess, select remedies, and implement remedial actions, the Parties commit to continually seek, develop, and use innovative technologies, processes, presumptive remedies, and other approaches. These actions will yield shorter schedules and cost-effective cleanup responses appropriate to the risks and with a bias for action. The Parties recognize that substantial onsite technical capabilities exist and will be leveraged to support accelerated cleanup.
9. The CCP metrics, to monitor progress, will be developed and mutually agreed to by the Parties. The Parties recognize that meeting or exceeding the CCP schedule may be jeopardized if resource limitations arise; therefore, prioritizing appropriate or additional resources is critical to achieving cleanup acceleration.
10. The Parties recognize that accelerating the SRS cleanup program and achieving area closure will require active involvement and/or direction from all levels within each of the Parties. The Parties agree to establish and support core teams to achieve the goal of cleanup completion.

**Memorandum of Agreement for Achieving an
Accelerated Cleanup Vision
Savannah River Site**

11. The Parties endorse the *Principles of Environmental Restoration* as set forth below, and commit to core team scoping and decision processes that utilize technical protocols for the performance of work and document templates for the reporting of the decisions.
12. The Parties recognize that this is an evolving process and changes may be required. This Agreement does not alter the Parties' obligations under the SRS FFA, which will remain fully operative under its existing terms unless and until the FFA is duly modified in accord with the process it contains for modification.

Principles of Environmental Restoration

1. Building an effective core team is essential.
2. Clear, concise, and accurate problem identification and definition are critical.
3. Early identification of likely response actions is possible, prudent, and necessary.
4. Uncertainties are inherent and will always need to be managed.

The following endorse this Memorandum of Agreement:



6/23/03

R. Lewis Shaw, Deputy Commissioner for
Environmental Quality Control
South Carolina Department of Health and Environmental Control

Date

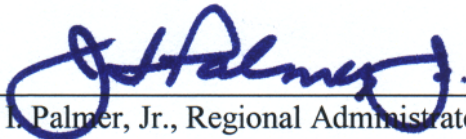

7/8/03

J. N. Palmer, Jr., Regional Administrator
U.S. Environmental Protection Agency – Region 4

Date

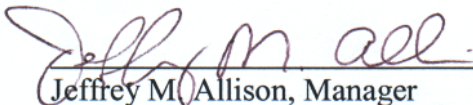

6/19/03

Jeffrey M. Allison, Manager
Savannah River Operations Office
U. S. Department of Energy

Date

**Memorandum of Agreement for Achieving an
Accelerated Cleanup Vision
Savannah River Site**

The following agree to implement this Memorandum of Agreement:

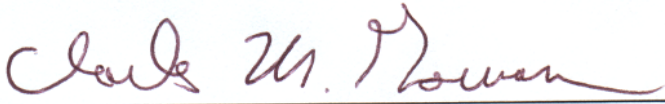
 June 19, 2003
Date
Charles M. Gorman, FFA Project Manager
Division of Site Assessment and Remediation
Bureau of Land and Waste Management
South Carolina Department of Health and Environmental Control

 June 17, 2003
Date
Brian T. Hennessey, FFA Project Manager
Environmental Restoration Division
Savannah River Operations Office
U.S. Department of Energy

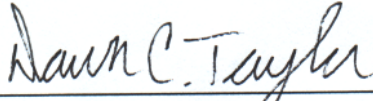
 June 27, 2003
Date
Dawn C. Taylor, FFA Project Manager
DOE Remedial Section
Federal Facilities Branch
Waste Management Division
U.S. Environmental Protection Agency – Region 4

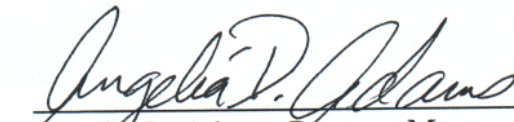
 June 18, 2003
Date
Angella D. Adams, Program Manager
Operations and Decommissioning Division
Savannah River Operations Office
U.S. Department of Energy

Area ROD to NPL Deletion Schedule Logic

Attachment 1

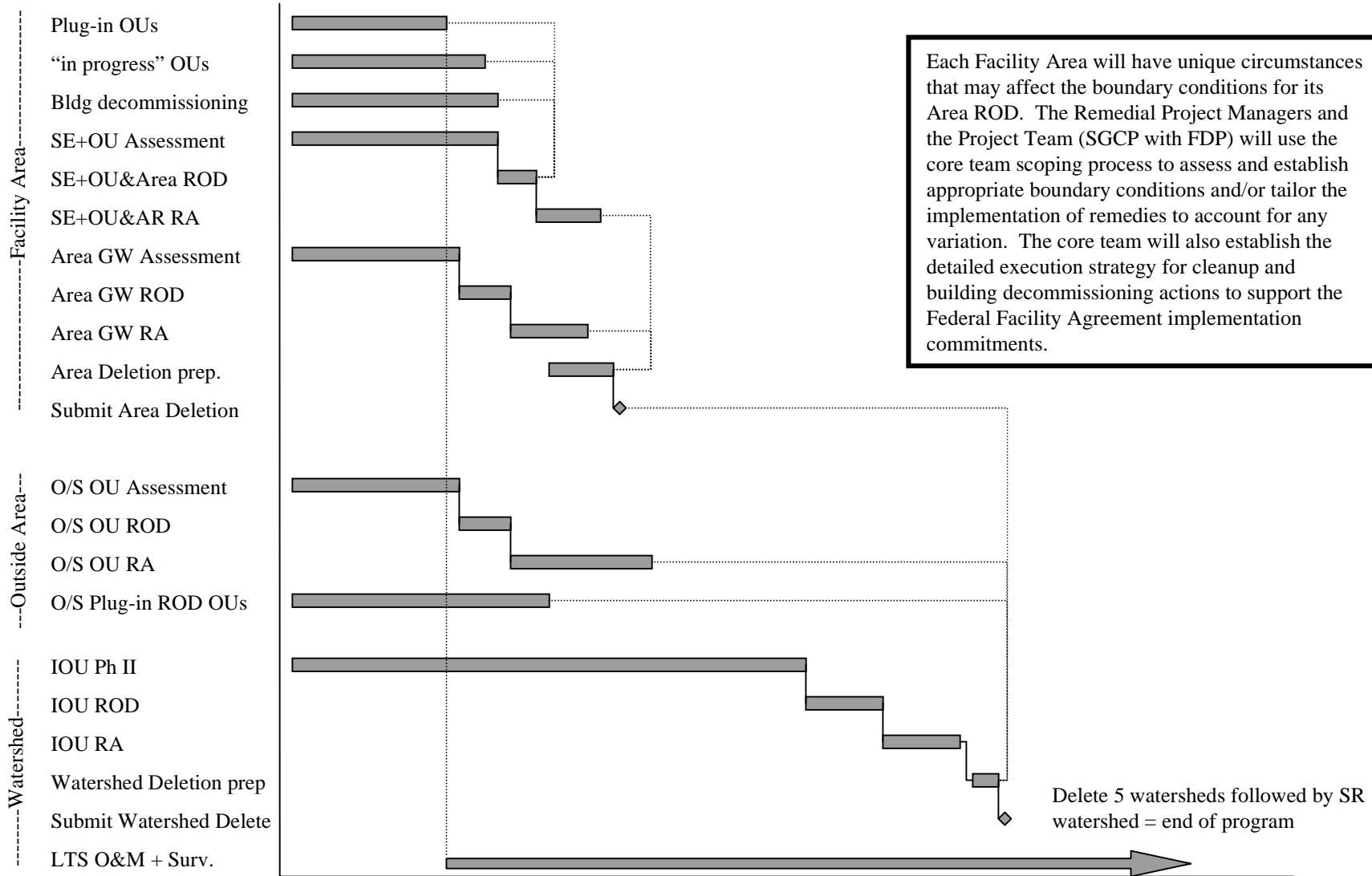

Each Facility Area will have unique circumstances that may affect the boundary conditions for its Area ROD. The Remedial Project Managers and the Project Team (SGCP with FDP) will use the core team scoping process to assess and establish appropriate boundary conditions and/or tailor the implementation of remedies to account for any variation. The core team will also establish the detailed execution strategy for cleanup and building decommissioning actions to support the Federal Facility Agreement implementation commitments.

Delete 5 watersheds followed by SR watershed = end of program

**Attachment 2
Administrative Flow Path for Decommissioning Excess Facilities**

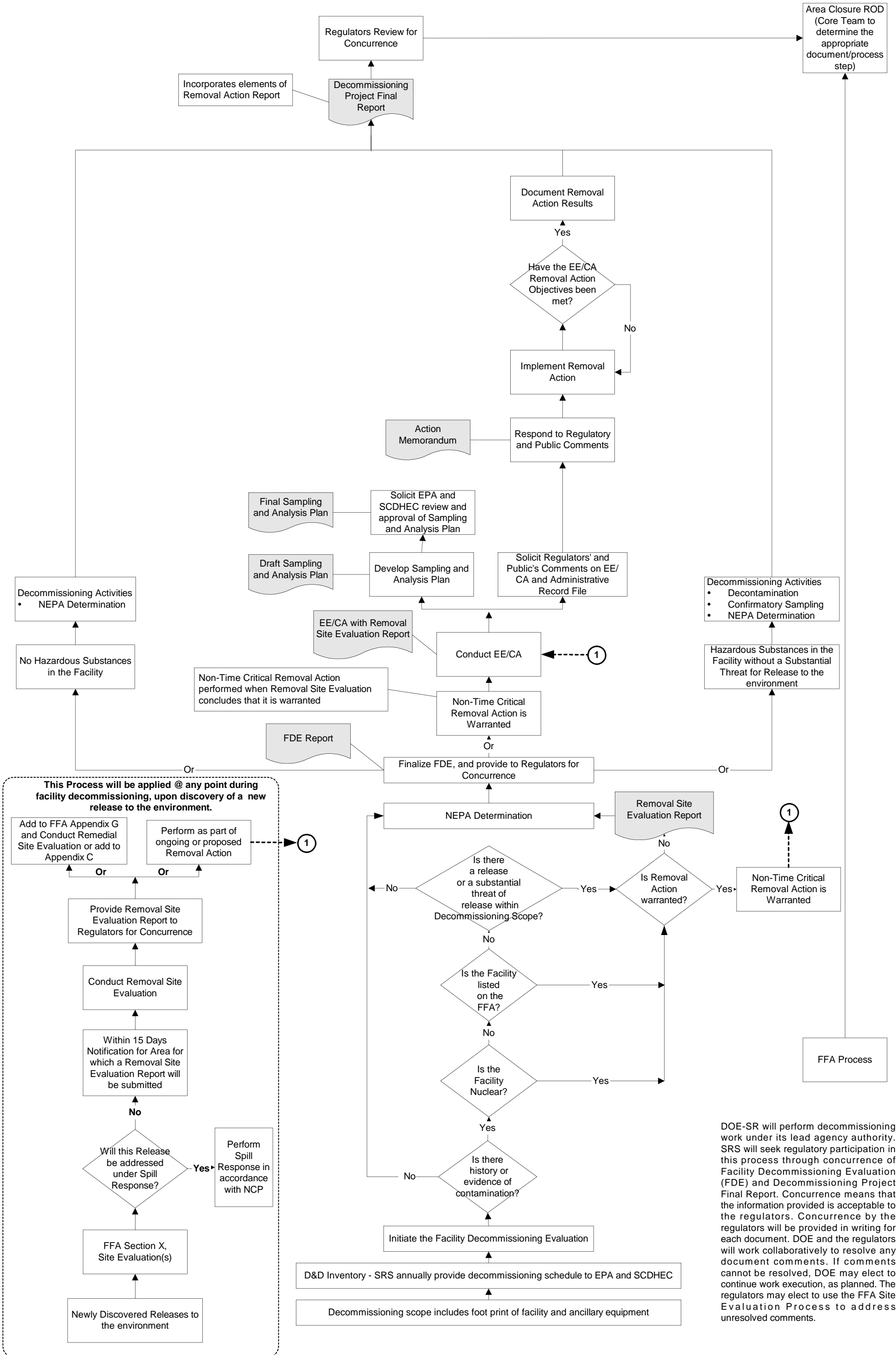

DOE-SR will perform decommissioning work under its lead agency authority. SRS will seek regulatory participation in this process through concurrence of Facility Decommissioning Evaluation (FDE) and Decommissioning Project Final Report. Concurrence means that the information provided is acceptable to the regulators. Concurrence by the regulators will be provided in writing for each document. DOE and the regulators will work collaboratively to resolve any document comments. If comments cannot be resolved, DOE may elect to continue work execution, as planned. The regulators may elect to use the FFA Site Evaluation Process to address unresolved comments.

**LETTER OF SUPPORT FOR ACCELERATING CLEANUP
AT THE SAVANNAH RIVER SITE
May 22, 2003**

Among the South Carolina Department of Health and Environmental Control (SCDHEC), the United States Environmental Protection Agency (EPA), and the United States Department of Energy (DOE) ("the Parties")

Foundation

In a Letter of Intent, dated May 8, 2002, the Parties established a foundation for accelerating cleanup at the Savannah River Site (SRS), and continue to recognize that foundation.

The Parties agreed that accelerating the reduction of risk and cleanup, in a cost-effective manner, is in the interest of the Parties, and the people of South Carolina and the region.

The Parties shared a vision for Environmental Management (EM) activities at SRS to accelerate completion of all cleanup by 2025.

The Parties have built a cooperative and effective relationship and base of success. The efforts contemplated herein will build on that success to mutual benefit, improving on the performance of a strong program. Such a commitment, including funding necessary to sustain the accelerated cleanup objectives, provides a truly significant opportunity to accelerate risk reduction and site cleanup.

The Parties agree that all activities will reflect the respective responsibilities of each, and will be done in compliance with applicable laws and regulations.

The Parties continue to value the importance of enforceable commitments to sustain progress.

The Parties agree, in setting priorities and cleanup strategies, to recognize, consider and include the principle of addressing greatest risks first, balanced by risk to workers, the public, and the environment.

Principles

Within the context of the above foundation, the Parties agree to:

- Support risk-based decision-making.

- Support accomplishment of Performance Management Plan (PMP) initiatives with the exception of those initiatives affected by ongoing federal litigation. The Parties are committed to the overall goals and objectives of the PMP, and will strive to make significant progress in PMP implementation recognizing that difficult policy and regulatory issues may arise. We will continue to seek opportunities that build on our mutual successes within the applicable laws, regulations, and agreements.
- Support EM accelerated cleanup beyond PMP initiatives. Through numerous productive collaborations and working sessions at all levels, EPA, SCDHEC and DOE are actively identifying opportunities for fulfilling their SRS Federal Facility Agreement and Site Treatment Plan obligations by using more efficient methods, leading to accelerated cleanup of the Site.

Jesse Hill Roberson, Assistant Secretary
for Environmental Management
U.S. Department of Energy

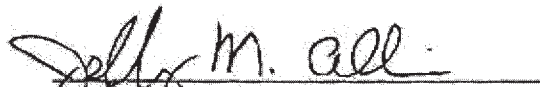

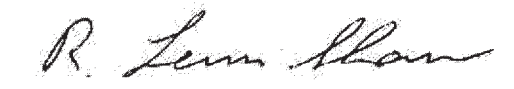
Jeffrey M. Allison, Manager
Savannah River Operations Office
U.S. Department of Energy

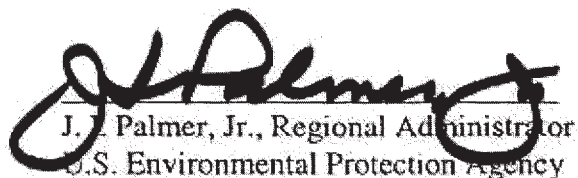
R. Lewis Shaw, Deputy Commissioner
for Environmental Quality Control
South Carolina Department of Health
and Environmental Control

J. J. Palmer, Jr., Regional Administrator
U.S. Environmental Protection Agency
Region 4

ATTACHMENT

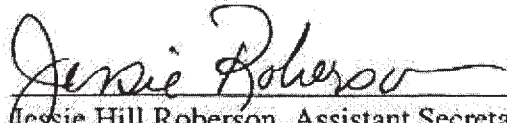
This Letter of Support satisfies compliance with Section 315 of Public Law 108-7 (Omnibus Appropriations Act for FY 2003).

Jessie Hill Roberson, Assistant Secretary
for Environmental Management
U.S. Department of Energy

memorandum

DATE: May 22, 2003

REPLY TO:
ATTN OF: EM-1

SUBJECT: Release of Fiscal Year (FY) 2003 Funding for Obligation

TO: Jeffrey M. Allison, Manager, Savannah River Operations Office

On March 21, 2003, in a funding allocation memorandum to you, I imposed a limitation on the level of FY 2003 obligations that could be incurred by the Savannah River Operations Office (SR) in the Environmental Management Program. That limitation of \$52,466,000 was imposed because of the absence of any documentation demonstrating regulatory endorsement of the SR Performance Management Plan.

In the interim period of time, SR has worked productively with both Federal and State regulators to establish an agreed to foundation for accelerating cleanup at the Savannah River Site (SRS) as evidenced in the May 22, 2003, Letter of Endorsement for Accelerating Cleanup at the SRS.

In my judgment, the referenced letter of endorsement satisfies the restrictive condition set forth by me in the March 21, 2003, funding allocation memorandum; accordingly, the imposed limitation is removed and SR can proceed with necessary actions to obligate the \$52,466,000.

Jessie Hill Roberson
Assistant Secretary for
Environmental Management

APPENDIX E

LONG TERM STEWARDSHIP

This appendix describes the national and Savannah River Site (SRS) perspectives on long-term stewardship.

National Perspective on Long Term Stewardship

Long Term Stewardship Report to Congress

In January 2001, the Department of Energy (DOE) published *A Report to Congress on Long-Term Stewardship*, containing the most comprehensive analysis to date of the DOE's existing and anticipated long-term stewardship obligations at DOE sites. The request for this report in the Fiscal Year (FY) 2000 National Defense Authorization Act (NDAA) reflects a continuing Congressional interest in long-term stewardship costs and management and demonstration of the degree of success achieved by nearly \$60 billion of environmental management funding.

The report identifies the long-term stewardship activities anticipated by DOE at as many as 129 sites by the year 2006. DOE already performs long-term stewardship activities at 34 sites that have been cleaned up and closed. While the primary focus of the report is on the anticipated scope, schedule, and cost for long-term stewardship activities from 2001 through the year 2006, the report also provides a preliminary glimpse of what DOE's long-term stewardship obligations may be post 2006.

There have been many interpretations of the term "long-term stewardship." Therefore, in the report, DOE defined long-term stewardship as follows:

...all activities necessary to ensure protection of human health and the environment following completion of

cleanup, disposal, or stabilization at a site or a portion of a site. Long-term stewardship includes all engineered and institutional controls designed to contain or to prevent exposure to residual contamination and waste, such as surveillance activities, record-keeping activities, inspections, groundwater monitoring, ongoing pump and treat activities, cap repair, maintenance of entombed buildings or facilities, maintenance of other barriers and containment structures, access control, and posting signs. ("Developing the Report to Congress on Long-Term Stewardship", June 2001.)

DOE's *Report to Congress on Long-Term Stewardship* reemphasizes DOE's commitment to long-term stewardship. The report recognizes:

- DOE has been and intends to continue performing cleanup to standards that do not allow for unrestrictive land use;
- Even if unrestricted land use were to be sought, it is often technically and economically infeasible;
- Consequently, long-term stewardship will be required for many years into the future; and
- Given the need for long-term stewardship to ensure the continued effectiveness of cleanup work, DOE intends to establish reliable management plans to carry out the long-term stewardship mission.

This report also emphasizes the role and responsibility of the DOE landlord function with respect to long-term stewardship activities. The policy directs the landlord program Secretarial Officers to be responsible for conducting the long-term stewardship program at their sites, unless other arrangements are made. The policy objective is to initiate actions that will lead

facility managers to plan, budget, and transition long-term stewardship activities in a timely manner.

Office of Legacy Management

In FY 2004 DOE requested and Congress approved a change in the management of long-term stewardship responsibility for DOE closure sites by creating the Office of Legacy Management (OLM) within DOE. The mission of the OLM is to manage the Department's post-closure responsibilities and ensure the future protection of human health and the environment. The OLM has control and custody for legacy land, structures and facilities and is responsible for maintaining them. As currently defined by Congress, this applies to closure sites. The January 2001 *Long-term Stewardship Congressional Report* assigns long-term stewardship to site landlords for non-closure sites. SRS is considered a non-closure site.

Environmental Management (EM) Completion

As part of DOE's continuing efforts to accelerate cleanup and follow-up actions from the *EM Top-to-Bottom Review*, a special EM-1 focus team developed and issued a definition of completion. (Definition of Environmental Management Completion Memo, Jessie Roberson to EM Field Office Managers, February 12, 2003.) SRS validated that these definitions were incorporated in the contractor's baseline. In addition, current plans are for EM to complete its work by 2025 and transition landlord responsibilities to the National Nuclear Security Administration (NNSA) during 2026.

Institutional Controls

In April 2003 DOE issued its *Use of Institutional Controls Policy* (DOE P 454.1). This policy delineates how the Department, including the National Nuclear Security Administration, will use institutional controls in

the management of resources, facilities, and properties under its control and to implement its programmatic responsibilities.

This policy is particularly significant to SRS regulators because it re-emphasizes DOE's commitment to perpetually maintaining institutional controls and seeks sufficient funds to do so. The policy states, "DOE will maintain the institutional controls as long as necessary to perform their intended protective purposes and seek sufficient funds." (DOE Policy P 454.1, *Use of Institutional Controls*, April 9, 2003.)

DOE uses a wide range of institutional controls as part of efforts to:

- appropriately limit access to, or uses of, land, facilities, and other real and personal properties;
- protect the environment (including cultural and natural resources);
- maintain the physical safety and security of DOE facilities; and
- prevent or limit inadvertent human and environmental exposure to residual contaminants and other hazards.

The policy states:

In situations where unrestricted use or unrestricted release of property is not desirable, practical, or possible, institutional controls are necessary and important to DOE efforts to fulfill its programmatic responsibilities to protect human health and the environment (including natural and cultural resources). It is DOE policy to use institutional controls as essential components of a defense-in-depth strategy that uses multiple, relatively independent layers of safety to protect human health and the environment (including natural and cultural resources). This strategy uses a graded approach to attain a level of protection appropriate to the risks involved. DOE will use a graded approach to determine what types and levels of protective measures (e.g., physical, administrative, etc.) should be used.

SRS Perspectives on Long-Term Stewardship

The SRS cleanup program has already accomplished significant risk reduction, but the “to-go” cleanup program to complete the task is also significant. As a result of DOE-WSRC contract modifications in 2003, 1013 EM facilities were identified as candidates for decommissioning. Of these 144 are considered nuclear facilities, 38 are considered radiological facilities, and 780 are considered industrial facilities. The 1013 facilities also include 51 high-level waste tanks, two of which are closed. To date, more than 100 facilities have been deactivated and decommissioned. In addition to the facilities, there are 515 waste units identified, of which, over 300 have been classified as either remediated or as requiring no further action.

All EM decommissioning activities are being integrated with soils and groundwater regulatory closure activities. Contamination in the foundations of facilities will be removed to a level that does not create an additional waste unit. The plan is to implement Area Closure Records of Decision, which will include remediation and deactivation and

decommissioning. These areas will be deleted from the National Priority List of Superfund sites as activities are completed.

In August 1999, Department of Energy – Savannah River (DOE-SR), Environmental Protection Agency (EPA) and South Carolina Department of Health and Environmental Control (SCDHEC) signed a Memorandum of Agreement that establishes the *Land Use Control Assurance Plan* (LUCAP), which effectively establishes and implements procedures to assure the long-term effectiveness of Land Use Controls (LUCs) consistent with regulatory cleanup in the *Federal Facility Agreement* for SRS. For every Record of Decision (ROD) that requires land use controls, the LUCAP is updated with a ROD-specific LUC implementation plan that defines the institutional controls and long-term stewardship requirements. Annually, the DOE-SR Manager certifies that the Land Use Controls are being maintained.

The process of identifying all the detailed requirements for long-term stewardship activities anticipated for the site is ongoing. This appendix provides the general framework for the long-term stewardship process at SRS.

THIS PAGE INTENTIONALLY LEFT BLANK

APPENDIX F

REFERENCES

Aiken, South Carolina: Economic Development Partnership, *Co-Production of Medical Radioisotopes, In the Proposed Accelerator Production of Tritium Facility. An Abbreviated Business Plan*, 1998.

Augusta Metro Chamber of Commerce, Augusta, Georgia, *Augusta Georgia Setting the Course for Business*, August 2000.

Brooks, Richard D. and Tonya Algerine Browder, *Memories of Home: Reminiscences of Ellenton*, Savannah River Archaeological Research Program, 1996.

Caudell, Michael B., *Crackerneck Wildlife Management Area and Ecological Reserve Comprehensive Natural Resource Management Plan*, South Carolina Department of Natural Resources, 2000.

City Council of North Augusta, SC, *Ordinance NO. 2001-05 To Approve The General Development Plan For The 1,513.8+ Acre Blanchard Park Planned Development Generally Located East Of US 25 and South of Ascauga Lake Road*, March 2001.

City of North Augusta: Department of Economic & Community Development, *North Augusta, South Carolina's Riverfront. Economic Profile*, 1999.

Comprehensive Environmental Response, Compensation and Liability Act (CERCLA). (<http://www.epa.gov/region5/defs/html/cercla.htm>)

Congressmen Charlie Norwood, J. Gresham Barrett, Joe Wilson, and Jim DeMint, *Resolution to the Defense Nuclear Facility Safety Board, DNFSB Recommendation 1994-1 to the Secretary of Energy*, May 26, 1994.

Defense Nuclear Facility Safety Board, *DNFSB Recommendation 2000-1 to the Secretary of Energy*, January 14, 2000. (http://www.dnfsb.gov/pub_docs/dnfsb/rec_2000_01.pdf)

Department of Energy Savannah River Operations Office, *Comprehensive Cleanup Plan*, (draft), September 30, 2003.

Department of Energy Savannah River Operations Office, *Federal Facility Agreement*, August 1993. (<http://www.srs.gov/general/enviro/erd/ffa/ffaa.pdf>)

Department of Energy Savannah River Operations Office, *Memorandum of Agreement: Implementation of a Land Use Controls Assurance Plan for the United States Department of Energy Savannah River Operations Office*, March 25, 2000. (<http://www.srs.gov/general/enviro/erd/gen/lucap/lucap.html>)

Department of Energy Savannah River Operations Office, *Memorandum of Agreement for Achieving an Accelerated Cleanup Vision Savannah River Site*, May 22, 2003. (<http://www.srs.gov/general/enviro/erd/gen/moaaccel.pdf>)

Department of Energy Savannah River Operations Office, *Performance Evaluation and Measurement Plan for WSRC LLC Contract No. DE-AC09-96SR185000, Modification No. M100*, June 18, 2003. (<http://sro.srs.gov/wsrcpubliccontract.pdf>)

Department of Energy Savannah River Operations Office, *Savannah River Site's Cold War Built Environment Cultural Resources Management Plan*, January 25, 2005.

Department of Energy Savannah River Operations Office, *Savannah River Site: Cold War Context and Resource Study*, 1999.

Department of Energy Savannah River Operations Office, *Savannah River Site Future Use Project Report: Stakeholder Recommendations for SRS Land and Facilities*, January 1996.

Department of Energy Secretary of Energy, *Statement of Principles*, September 1999.

Department of Energy, *A Review of the Environmental Management Program; Top-To-Bottom Review Team*, Feb., 4, 2002. (http://www.em.doe.gov/vgn/images/portal/cit_1819/34/15/16859ttbr.pdf)

Department of Energy, *A Strategic Approach to Integrating the Long-Term Management of Nuclear Materials: The Department of Energy's Integrated Nuclear Materials Management Plan*, June 2000.

Department of Energy, *Closure Plan and Performance Assessment for F- and H-Area High Level Waste Tank Systems – Preliminary Draft*, Revision 2, August 14, 2000.

Department of Energy *Consolidated Record of Decision for Tritium Supply and Recycling Environmental Impact Statement*, May 14, 1999. (<http://www.eh.doe.gov/nepa/bbs/ftpup/fedreg/63877.pdf>)

Department of Energy *Supplemental Environmental Impact Statement on Salt Processing Alternatives (DOE/EIS-0082-S2D)*; July 2001. (<http://www.eh.doe.gov/nepa/eis/eis0082S2/eis0082s2.html>)

Department of Energy *Environmental Impact Statement on High Level Waste Tank Closure (DOE/EIS-0303*; May 2002). (<http://www.eh.doe.gov/nepa/eis/eis0303/eis0303.html>)

Department of Energy, *Defense Waste Processing Facility Final Environmental Impact Statement*, DOE/EIS-0082.

Department of Energy, *Defense Waste Processing Facility Final Supplemental Environmental Impact Statement*, DOE/EIS-0082-S. (http://www.eh.doe.gov/nepa/eis/eis0082S/eis0082s_toc.html)

Department of Energy, *Developing the Report to Congress on Long-Term Stewardship*, June 2001. (<http://its.apps.em.doe.gov/center/reports/pdf/doc222.pdf>)

Department of Energy, DOE Order 430.1B, *Real Property Asset Management*, September 24, 2003. (<http://www.directives.doe.gov/directives/current.html#number>)

Department of Energy, DOE Policy P 454.1, *Use of Institutional Controls*, April 9, 2003. (<http://www.directives.doe.gov/directives/current.html#number>)

Department of Energy, DOE Policy P 455.1, *Use of Risk-Based End States*, July 15, 2003.
(<http://www.directives.doe.gov/directives/current.html#number>)

Department of Energy, DOE Policy P 580.1, *Management Policy for Planning, Programming, Budgeting, Operation, Maintenance, and Disposal of Real Property*, May 5, 2002.
(<http://www.directives.doe.gov/directives/current.html#number>)

Department of Energy, *DOE Report to Congress: Planning For The Future, An Overview Of Future Use Plans At Department Of Energy Sites*, October 7, 1998.

Department of Energy, *DOE Strategic Plan, Protecting National, Energy, and Economic Security with Advanced Science and Technology and Ensuring Environmental Cleanup*, September 30, 2003.
(<http://strategicplan.doe.gov/>)

Department of Energy, *DOE/EM-0563 DOE Report to Congress on Long Term Stewardship, Volume I – Summary Report*, Jan. 2001. (<http://its.apps.em.doe.gov/center/reports/pdf/doc222.pdf>)

Department of Energy, *Environmental Assessment for the Construction and Operation of the Highly Enriched Uranium Blend-Down Facilities at the Savannah River Site*, DOE/EA-1322, April 2000.
(http://www.eh.doe.gov/nepa/ea/ea_toc.html)

Department of Energy, *High Level Waste Tank Closure Final Environmental Impact Statement*, DOE/EIS-0303, May 2002. (<http://www.eh.doe.gov/nepa/eis/eis0303/eis0303.html>)

Department of Energy, *HW/MW Area Inspections (U)*, SW 15.6-INP-HWMW01, Rev. 8.

Department of Energy, *Implementation Plan for the Remediation of Nuclear Materials in the Defense Nuclear Facilities Complex, Revision 3*, May 31, 2000.

Department of Energy, *Nuclear Criticality Safety Evaluation: Double Contingency Analysis for the L Disassembly Basin*, N-NCS-L-00018, Rev. 0, December 2002.

Department of Energy, *Record of Decision for the Savannah River Site Spent Nuclear Fuel Management Environmental Impact Statement*, August 7, 2000. (<http://www.eh.doe.gov/nepa/rods/2000/48224.pdf>)

Department of Energy, *Record of Decision for the Surplus Plutonium Disposition Final Environmental Impact Statement*, January 11, 2000. (<http://www.eh.doe.gov/nepa/rods/2000/1608.pdf>)

Department of Energy, *Routine Inspections for the Hazardous Waste/Mixed Waste Facility (U)*, SW 15.6-INP-HWMW02, Rev. 7.

Department of Energy, *Savannah River Site High-Level Waste Tank Closure Record of Decision*, August, 19, 2002. (<http://www.eh.doe.gov/nepa/rods/2002/53784.pdf>)

Department of Energy, *Top-to-Bottom Review of the EM Program*, February 4, 2002.
(<http://web.em.doe.gov/ttbr.pdf>)

Economic Development Partnership, *Aiken and Edgefield Counties 1997-1998 Economic Profile*, 1997.

Executive Order 12898, *Federal Actions to Address Environmental Justice in Minority Populations and Low-Income Populations*, 1994.
(<http://www.hud.gov/offices/cpd/energyenviron/environment/lawsandregs/laws/lawsauthorities/eo/12898.cfm>)

Frisch, Michael and David A. Lewis, "What Happened to Conversion in the Nuclear Weapons Complex? An Analysis of Regional Spending on Environmental Management and Defense Programs in the Department of Energy", *Report 34, Social, Land Use, Demographic, Geographic and Economic Task Group*, Consortium for Risk Evaluation with Stakeholder Participation, New Brunswick, NJ, February 2000. (Contact the Consortium for Risk Evaluation with Stakeholder Participation at their website: <http://www.cresp.org/>)

Georgia Department of Labor, *Annual Average Civilian Labor Force Data, 1980-1999*, Labor Information Systems, 1999.

Georgia Department of Labor, *Georgia Employment and Wages Averages*, 1996.

Greenberg, Michael and Darien Simon, "Economic Characteristics of Counties Adjacent to the Savannah River, Hanford, and Other Major U.S. Department of Energy Sites", *Report 2, Social, Land Use, Demographic, Geographic and Economic Task Group*, Consortium for Risk Evaluation with Stakeholder Participation, New Brunswick, NJ, January, 1998. (Contact the Consortium for Risk Evaluation with Stakeholder Participation at their website: <http://www.cresp.org/>)

Greenberg, Michael, et. al., "Economic Impact of Accelerated Cleanup on Regions Surrounding the U. S. DOE's Major Nuclear Weapons Sites", *Report 14, Social, Land Use, Demographic, Geographic and Economic Task Group*, Consortium for Risk Evaluation with Stakeholder Participation, New Brunswick, NJ, February 2000. (Contact the Consortium for Risk Evaluation with Stakeholder Participation at their website: <http://www.cresp.org/>)

Greenberg, Michael, et. al., "Regional Economic Impact of the Changing Role of U.S. Department of Energy Facilities: the Case of the Savannah River Site Region, and the States of South Carolina and Georgia", *Report 22, Social, Land Use, Demographic, Geographic and Economic Task Group*, Consortium for Risk Evaluation with Stakeholder Participation, New Brunswick, NJ, February 1999. (Contact the Consortium for Risk Evaluation with Stakeholder Participation at their website: <http://www.cresp.org/>)

Greenberg, Michael, et. al., "The U. S. Department of Energy's Regional Economic Legacy", *Report 35, Social, Land Use, Demographic, Geographic and Economic Task Group*, Consortium for Risk Evaluation with Stakeholder Participation, New Brunswick, NJ, February 2000. (Contact the Consortium for Risk Evaluation with Stakeholder Participation at their website: <http://www.cresp.org/>)

Grewal, Harpal S. and J. Christopher Noah, *The Economic Impact of the Savannah River Site on South Carolina and Georgia*, WSRC-RP-97-00974, November 1997.

Grewal, Harpal S. and J. Christopher Noah, *The Economic Impact of the Savannah River Site on South Carolina and Georgia, Second Edition*, WSRC-RP-2001-00745, July 2001.

Grewal, Harpal S. and J. Christopher Noah, *The Economic Impact of the Savannah River Site on South Carolina and Georgia, Third Edition*, May 2004.

Halliburton NUS Environmental Corporation, *Socioeconomic Characteristics of Selected Counties and Communities Adjacent to the Savannah River Site*, June 1997.

Lewis, David et. al., “Downsizing and Work Separations: Modeling the Regional Economic Impacts of Alternative Department of Energy Workforce Adjustment Policies”, *Report 37, Social, Land Use, Demographic, Geographic and Economic Task Group*, Consortium for Risk Evaluation with Stakeholder Participation, New Brunswick, NJ, January 2001. (Contact the Consortium for Risk Evaluation with Stakeholder Participation at their website: <http://www.cresp.org/>)

Lower Savannah Council of Governments, *A Comprehensive Regional Economic Development Plan*, Aiken, SC, undated. (Contact the Lower Savannah Council of Governments at their website: <http://www.lscog.org/>)

Lower Savannah Council of Governments, *Barnwell County Comprehensive Plan*, September 2002. (Contact the Lower Savannah Council of Governments at their website: <http://www.lscog.org/>)

Lower Savannah Council of Governments, *Comprehensive Economic Development Strategy* (for six-county region), 2002. (Contact the Lower Savannah Council of Governments at their website: <http://www.lscog.org/>)

Lower Savannah Council of Governments, *Comprehensive Economic Development Strategy* (for six-county region) (draft), 2004. (Contact the Lower Savannah Council of Governments at their website: <http://www.lscog.org/>)

Lower Savannah Council of Governments, *Lower Savannah Intermodal Network A Transportation Primer for the Lower Savannah Region*, 2002. (Contact the Lower Savannah Council of Governments at their website: <http://www.lscog.org/>)

Lower Savannah Council of Governments, *Memorandum to Christopher Noah, “Lower Savannah Demographic Profiles, Ten to One Hundred Mile Radius, South Carolina Report, 2003”*, June 4, 2004. (Contact the Lower Savannah Council of Governments at their website: <http://www.lscog.org/>)

Lower Savannah Council of Governments, *Savannah River Regional Diversification Initiative Economic Development Plan for the Central Savannah River Area*, December 1995. (Contact the Lower Savannah Council of Governments at their website: <http://www.lscog.org/>)

Lowrie, Karen and Michael Greenberg, “Placing Future Land Use Planning in a Regional Context: The Savannah River Site”, *Federal Facilities Environmental Journal*, Spring 1997. (Contact the Consortium for Risk Evaluation with Stakeholder Participation at their website: <http://www.cresp.org/>)

Memo, J. M. Allison to R. A. Pedde, *Environmental Management Life Cycle Baseline – Required Program Guidance*, September 16, 2003.

Memo, J. M. Allison to R. A. Pedde, *Preparation of Environmental Management (EM) Program Performance Management Plan (PMP) Revision*, March 5, 2004.

Memo, Jessie Roberson to EM Field Office Managers, *Definition of Environmental Management Completion Memo*, February 12, 2003.

Memo, Mario P Fiori to Thomas P. Grumbly, *SRS Future Use Project Report*, Jan., 1996.

Memo, President Bill Clinton and President Putin of Russia, *Joint Statement Between the United States and Russia on Non-Proliferation of Weapons of Mass Destruction and the Means of Their Delivery*, January 1994.

National Oil and Hazardous Substances Pollution Contingency Plan.
(<http://www.epa.gov/oilspill/ncpover.htm>)

National Research Council of the National Academies, *Improving the Characterization and Treatment of Radioactive Wastes for the Department of Energy's Accelerated Site Cleanup Program*, The National Academies Press, Washington, DC, 2005

National Research Council of the National Academies, *Risk and Decisions about Disposition of Transuranic and High Level Radioactive Waste*, The National Academies Press, Washington, DC, 2005

Noah, J. C., et. al., *Land Use Baseline Report - Savannah River Site*, June 1995.

Noah, J. C., *The Cold War, Federal Weapons Facilities and the South - Status and Future*, April 26, 1997.

Phifer and Nelson, *Saltstone Disposal Facility Closure Cap Configuration and Degradation Base Case: Institutional Control to Pine Forest*, WSRC-TR-2003-00436, 2003.

President Bill Clinton, *Non-proliferation and Export Control Policy*, September 1993.

Programmatic Agreement Among the U. S. Department of Energy (DOE), the South Carolina State Historic Preservation Office (SHPO), and the Advisory Council on Historic Preservation (ACHP) for the Management of Cold War Historic Properties on the Savannah River Site (SRS), Aiken, Barnwell, and Allendale Counties, South Carolina, May 2004.

Resource Conservation and Recovery Act (RCRA).
(http://www.access.gpo.gov/uscode/title42/chapter82_.html)

S.C. Department of Commerce, *2000 South Carolina Industrial Directory*, 1999.

Savannah River Regional Diversification Initiative, *1996 Annual Report of Savannah River Regional Diversification Initiative*, 1996.

Savannah River Site Citizen's Advisory Board Recommendation No. 8, *Future Land Use*, September 26, 1995. (<http://www.srs.gov/general/outreach/srs-cab/recommnds/reccom8.html>)

Savannah River Site, *SRS Environmental Management Integrated Deactivation and Decommissioning Plan*, May 2003. (

Savannah River Site, *SRS Environmental Management Program Performance Management Plan*, August 7, 2002. (<http://www.srs.gov/general/pubs/PMP.pdf>)

Savannah River Site, *SRS Environmental Management Program Performance Management Plan*, April 2004.

Savannah River Site, *SRS Environmental Management Program Performance Management Plan*, 2005.

Savannah River Site, *SRS Future Use Plan*, March 1998.

Savannah River Site, *SRS Long Range Comprehensive Plan*, Dec., 2000.

Savannah River Site, *SRS Strategic Plan, 21st Century Stewards for the Nation*, March 2000. (<http://www.srs.gov/general/pubs/stratplan/strplan.pdf>)

South Carolina Employment Security Commission, *South Carolina Labor Market Review Annual Report*, 1987.

South Carolina Employment Security Commission, *South Carolina Labor Market Review Annual Report*, 1988.

South Carolina Employment Security Commission, *South Carolina Labor Market Review Annual Report*, 1989.

South Carolina Employment Security Commission, *South Carolina Labor Market Review Annual Report*, 1990.

South Carolina Employment Security Commission, *South Carolina Labor Market Review Annual Report*, 1991.

South Carolina Employment Security Commission, *South Carolina Labor Market Review Annual Report*, 1992.

South Carolina Employment Security Commission, *South Carolina Labor Market Review Annual Report*, 1993.

South Carolina Employment Security Commission, *South Carolina Labor Market Review Annual Report*, 1994.

South Carolina Employment Security Commission, *South Carolina Labor Market Review Annual Report*, 1995.

South Carolina Employment Security Commission, *South Carolina Labor Market Review Annual Report*, 1996.

South Carolina Employment Security Commission, *South Carolina Labor Market Review Annual Report*, 1997.

South Carolina Employment Security Commission, *South Carolina Labor Market Review Annual Report*, 1998.

South Carolina Employment Security Commission, *South Carolina Labor Market Review Annual Report*, 1999.

South Carolina Employment Security Commission, *South Carolina Labor Market Review Annual Report*, 2000.

Staff of Augusta-Richmond County Planning Commission, Augusta-Richmond GA, *Augusta-Richmond County Comprehensive Plan*, 2003.

U.S. Bureau of the Census, *Estimates of the Population by Counties, 1999-2001*, 2001. (<http://www.census.gov/>)

U.S. Department of Commerce, *Personal Income By States and Counties, 1987-1998* 1998. (<http://www.commerce.gov/>)

U.S. Department of Commerce, *Regional Multipliers: A User Handbook for the Regional Input-Output Modeling System (RIMSII), Second Edition*, May 1992. (<http://www.commerce.gov/>)

University of South Carolina-Aiken, *The Comprehensive Study of the Labor Market of the Central Savannah River Area*, December 1996.

Urban College Inc., *Columbia County Growth Management Plan*, 2001.

Westinghouse Savannah River Company, *Defense Waste Processing Facility Safety Analysis Report*, WSRC-SA-6, Rev.17.

Westinghouse Savannah River Company, *Defense Waste Processing Facility Glass Production Control Program*, WSRC-IM-91-116-6, Rev. 2.

Westinghouse Savannah River Company, *Emergency Preparedness Hazard Assessment for the Concentration, Storage and Transfer Facilities*, S-EHA-G-00002, Rev 6, April 2004.

Westinghouse Savannah River Company, *FB-Line Safety Analysis Report*, WSRC-SA-2002-00006, Rev. 2B, September 2004.

Westinghouse Savannah River Company, *FB-Line Technical Safety Requirements*, WSRC-TS-98-00002, Rev. 3B, September 2004.

Westinghouse Savannah River Company, *F-Canyon Technical Safety Requirement*, WSRC-TS-97-00015, Rev.1A, September 2004.

Westinghouse Savannah River Company, *HB-Line Continued Operation with Alternate Hydrogen Control for Phase I Scrap Recovery Processing*, Justification for Continued Operation, WSRC-RP-2002-00615, Rev.2, January 20, 2005.

Westinghouse Savannah River Company, *HB-Line Safety Analysis Report (U)*, Safety Analysis Report; WSRC-SA-2001-00009, Rev. 4, October 2004.

Westinghouse Savannah River Company, *HB-Line Technical Safety Requirements (U)*, Technical Safety Requirements: WSRC-TS-97-7, Rev. 18, October 2004.

Westinghouse Savannah River Company, *HB-Line Technical Safety Requirements (U)*, Technical Safety Requirements, WSRC-TS-97-7, Rev. 18, October 2004.

Westinghouse Savannah River Company, *H-Canyon and Outside Facilities Technical Safety Requirements (U)*, WSRC-TS-96-19, Rev. 9, February 2004.

Westinghouse Savannah River Company, *H-Canyon Safety Analysis Report (U)*, WSRC-SA-2001-00008, Rev. 5, February 2004.

Westinghouse Savannah River Company, *High Level Waste System Plan*, Rev.13. HLW02002-00025.

Westinghouse Savannah River Company, *Industrial Wastewater Closure Plan for F- and H-Area High Level Waste Tank System*, WSRC-2003-00498, August 16, 2004

Westinghouse Savannah River Company, *Justification for Continued Operations, Savannah River Site, Upgraded Interim Control Posture for Building 235-F*, WSRC-RP-2004-00432, Rev. 0, June 2004.

Westinghouse Savannah River Company, *K-Area Material Storage Facility Documented Safety Analysis*, WSRC-SA-2002-00005 1, Rev 1, June 2004.

Westinghouse Savannah River Company, *L-Area Material Storage Facility Documented Safety Analysis*, WSRC-SA-2004-00002, Rev. 0, June 2004.

Westinghouse Savannah River Company, *Limited Extent Surveillance Modification (Addendum to the 235-F Safety Analysis Report)*, WSRC-RP-89-575, Rev. 0, April 2004.

Westinghouse Savannah River Company, *PMP Supplement to the High Level System Plan*, Rev.13, HLW-2002-00161.

Westinghouse Savannah River Company, Procedure Manual 3Q, *Environmental Compliance Manual*.

Westinghouse Savannah River Company, Procedure Manual 1S, *SRS Waste Acceptance Criteria Manual*, WAC 3.18 Rev. 4, 02/01/02.

Westinghouse Savannah River Company, Procedure Manual E7, *Conduct of Engineering Manual*

Westinghouse Savannah River Company, *Processing Pu Contaminated Scrap in H-Canyon (U)*, JCO, WSRC-RP-2004-00283, Rev. 0, September 2004.

Westinghouse Savannah River Company, *Radioactive Waste Management Basis (RWMB)*.

Westinghouse Savannah River Company, *Radiological Performance Assessment for the E Area Low Level Waste Facility*, WSRC-RP-94-218.

Westinghouse Savannah River Company, *Safety Analysis – 200 Area Savannah River Site Building 235-F*, WSRC-RP-89-575, Rev.3, January 2003.

Westinghouse Savannah River Company, *Safety Analysis Report F-Canyon, A-Line, and Outside Facilities*, WSRC-SA-2001-00004, Rev. 3A, September 2004.

Westinghouse Savannah River Company, Solid Waste 18 Manual, *Solid Waste and Infrastructure Manual*.

Westinghouse Savannah River Company, *Solid Waste Management Facility Safety Analysis Report*, WSRC-SA-22 Rev. 4, May 2003.

Westinghouse Savannah River Company, *Solid Waste Management Facility Safety Technical Safety Requirements*, WSRC-TS-95-16, Rev. 5, July 2004.

Westinghouse Savannah River Company, *SRS Waste Acceptance Criteria Manual*, Manual 1S, Revision 9, January 14, 2005

Westinghouse Savannah River Company, *Technical Safety Requirements Savannah River Site, K-Material Storage Facility*, WSRC-TS-96-20, Rev.18, November 21, 2004.

Westinghouse Savannah River Company, *Technical Safety Requirements, Savannah River Site, Building 235-F*, WSRC-TS-97-3, Rev. 7, November 4, 2004.

Westinghouse Savannah River Company, *Technical Safety Requirements Savannah River Site, L-Material Storage Facility*, S-TSR-L-00002, Rev. 0, October 2004.

Westinghouse Savannah River Company, *Tritium Facilities Technical Safety Requirements*, WSRC-TS-96-17, October 2003.

Westinghouse Savannah River Company, *Tritium Safety Analysis Report*, WSRC-SA-1-2, October 2003.

Westinghouse Savannah River Company, *Use of Gadolinium as a Neutron Poison for Pu Solutions in H-Canyon (U)*, JCO, WSRC-RP-2002-00632, Rev. 0, December 2002.

APPENDIX G

LAND USE, RISK AND CLEANUP DECISION PROCESS

Risk

Risk is defined as the chance of injury, damage, or loss. Therefore, to put oneself “at risk” means to participate either voluntarily or involuntarily in an activity or activities that could lead to injury, damage, or loss due to exposure to a hazard or danger.

Expressed another way:

$$\text{Risk} = \text{Probability} \times \text{Hazard}$$

Or

$$\text{Risk} = \text{Exposure} \times \text{Toxicity}$$

Quantitative risk is a numerical expression of the probability or likelihood an injury or accident will occur. (e.g., $3.1 \times 10^{-6} = 3.1$ chances in a million)

Qualitative risk is a “relative” measure. (e.g., high, medium, low)

Examples of relative risk of 1 in a million chances of dying from activities common to our society:

- smoking 1.4 cigarettes (lung cancer)
- eating 40 tablespoons of peanut butter
- spending 2 days in NYC (air pollution)
- driving 40 miles in a car (accident)
- flying 2500 miles in a jet (accident)
- canoeing for 6 minutes
- receiving 10 millirem of radiation (cancer)

Other examples of depicting &/or comparing risk for common conditions/occurrences in our society. (See box on Health Risks and Estimated Loss of Life Expectancy.)

Hazard is defined as a source with the potential to cause illness, injury, or death to humans or damage to the environment. The nature (i.e., toxicity, quantity, form, mobility, etc.) of the hazardous material is key in determining risk.

Determination of risk:

1. **Statistically verifiable risks** are risks for voluntary or involuntary activities that have been determined from direct observation. These risks can be compared to each other.
2. **Statistically nonverifiable risks** are risks from involuntary activities that are based on limited data sets and mathematical equations. These risks can also be compared to each other, but no comparison should be made between verifiable and nonverifiable risks.

Health Risk	Estimated Loss of Life Expectancy
Smoking 20 cigarettes a day	6 years
Overweight (by 15%)	2 years
Alcohol consumption (U.S. average)	1 year
Agricultural accidents	320 days
Construction accidents	227 days
Auto accidents	207 days
Home accidents	74 days
Occupational radiation dose (1 rem/y, from age 18-65 (47 rem total))	51 days
All natural hazards (earthquakes, lightning, flood)	7 days
Medical radiation	6 days

Factors affecting perception of risk:

- Voluntary risks are more acceptable than risks perceived to be imposed.
- Risks under an individual’s control are more acceptable than those controlled by others.
- Familiar risks are more acceptable than exotic risks.
- Fairly distributed risks are more acceptable than biased risks.
- Natural risks are more acceptable than man made risks.

- Risks with clear benefits are more acceptable than risks with little or no benefits.
- Risks to adults are more acceptable risks than risks to children.
- Risks generated by a trusted source are more acceptable than risks generated by an untrusted source.

Land Use and Risk Receptors

Reasonably anticipated land use is an important consideration in determining whether there is a current risk associated with a waste site while future land use is important in estimating potential future threats. Once a land use determination is made, risk is assessed for the appropriate human and ecological receptors. The results of the risk assessment aid in determining the degree of remediation necessary to ensure long-term protection of current and future receptors at the waste site.

SRS is expected to remain an industrial site and future residential land use is not anticipated. Potential human health and ecological receptors at SRS include:

1. **Current On-Unit Industrial Worker**

SRS employees who currently work at or in the vicinity of the waste unit. A current on-unit industrial worker may be a researcher, environmental sampler, or other SRS personnel that performs work at the site on an infrequent or occasional basis. Although these receptors may be involved in the excavation or collection of contaminated media, they would use SRS procedures and protocols for sampling at hazardous waste units.

2. **Future Industrial Worker**

The scenario addresses long-term risks to workers who are exposed to unit-related constituents while working in an industrial setting. The future industrial worker is a person who works in an outdoor industrial setting that is in direct proximity to the

contaminated media for the majority of their time.

3. **Maintenance Worker (Future)**

A conservative (but plausible) receptor at a mostly unoccupied site (e.g., a fenced or isolated area). The maintenance worker scenario addresses long-term risks to workers who may visit an inactive, closed area on an infrequent or occasional basis. The majority of the worker's time would be comprised of maintenance activities, such as ant control, landscaping, site inspections, or perimeter security verification, or sampling/monitoring of environmental conditions.

4. **Trespasser**

An individual that intrudes on areas of the site where industrial development is not feasible. (e.g., near site streams and/or boundaries that have potential offsite access). The frequency of intrusion is dependent on accessibility, distance from the site boundary, and attractiveness of the site.

5. **Ecological Receptors**

Ecological receptors (i.e., wildlife and vegetation) are based on the ecosystem, communities, and species observed at the site that may be currently exposed to contaminants or may be exposed in the future. The ecological scenario focuses on effects to the overall ecosystem through all trophic levels.

To determine a baseline risk for the appropriate receptor scenario, contaminant concentrations obtained during a waste unit investigation are evaluated against background or naturally occurring concentration levels and predetermined screening values. Screening values are based on the applicable receptor scenario and represent concentrations that if exceeded, would result in an unacceptable risk or hazard to human health receptors and/or the environment.

Upon determining that waste unit concentrations are greater than background and contaminant

specific screening values, a comprehensive risk evaluation, in addition to an assessment of the nature, extent, fate, and transport of contamination, is conducted. Contaminants of potential concern identified during the comprehensive analysis are further evaluated by an uncertainty analysis which includes, but is not limited to, the nature and extent of contamination, history of use at the waste site, presence in background, analytical data quality, toxicity information, and presence in other media (i.e., transport to groundwater).

If contaminant concentrations are determined to be present at unacceptable levels following the uncertainty analysis, a risk management decision is made that the waste unit requires remediation and the remedial alternative selection process is initiated. The remedy selection process typically employs an evaluation utilizing the following nine criteria:

Threshold Criteria

1. Overall Protection of Human Health and the Environment determines whether a remedial alternative eliminates, reduces, or controls threats to public health and the environment through institutional controls, engineering controls, or treatment.
2. Compliance with Applicable or Relevant and Appropriate Requirements evaluates whether the alternative meets Federal and State environmental statutes, regulations, and other requirements that pertain to the site, or whether a waiver is justified.

Balancing Criteria

1. Long-term Effectiveness and Permanence considers the ability of an alternative to

maintain protection of human health and the environment over time.

2. Reduction of Toxicity, Mobility, or Volume of Contaminants through Treatment evaluates an alternative's use of treatment to reduce the harmful effects of principal contaminants, their ability to move in the environment, and the amount of contamination present.
3. Short-term Effectiveness considers the length of time needed to implement an alternative and the risks the alternative poses to workers, residents, and the environment during implementation.
4. Implementability considers the technical and administrative feasibility of implementing the alternative, including factors such as the relative availability of goods and services.
5. Cost includes estimated capital and annual operations and maintenance costs, as well as present worth cost. Present worth cost is the total cost of an alternative over time in terms of today's dollar value. Cost estimates are expected to be accurate within a range of +50 to -30 percent.

Modifying Criteria

1. State/Support Agency Acceptance considers whether the State agrees with the analyses and recommendations.
2. Community Acceptance considers whether the local community agrees with the analyses and preferred alternative.

Upon a successful detailed comparative analysis of the potential remedial alternatives, coupled with the risk management decision(s) as a result of the investigation and risk assessment, a preferred alternative is selected.

THIS PAGE INTENTIONALLY LEFT BLANK

APPENDIX H

PUBLIC COMMENT MATRIX

This section includes the following information:

- Savannah River Site (SRS) Citizen's Advisory Board (CAB) Recommendation 216, *End State Vision*, with the Department of Energy (DOE) response
- Comments received on the March 2005 version of the *End State Vision* with DOE responses
- SRS CAB Recommendation 190, *Risk-Based End State Vision*, with DOE response
- Comments received on the March 2004 version of the *Risk-Based End State Vision* with DOE responses

NOTE: Each section has its own set of page numbers. The page numbers at the bottom are page numbers for the entire section.



Savannah River Site Citizens Advisory Board

Recommendation 216 End State Vision

Background

Since the 2002 independent review team's *Top-to-Bottom Review*, the Department of Energy's (DOE) Office of Environmental Management (EM) has taken aggressive action from simply managing risk to accelerating risk reduction by expeditiously cleaning up the Cold War legacy. In March 2004, DOE-EM developed a site-specific *Risk-Based End State* (RBES) Vision Document for each DOE site, pursuant to DOE Policy 455.1, *Use of Risk-based End States*, and associated guidance (Ref. 1).

Based upon feedback from the National Governors' Association Next Steps Workshop in October 2004, the title of this document was changed from RBES to simply *End State Vision* (ESV). Since End States are not strictly "risk-based" but are logical, technically defensible, and protective of human health and the environment the "risk-based" nomenclature was dropped in this new draft document. This draft ESV is more comprehensive than the March 2004 draft. It now describes current conditions and planned end states for contained and released hazards, where the earlier draft focused only on released hazards for inactive soil and groundwater units and EM legacy facilities. In addition, the previous draft used the word "Variances" to describe significant different cleanup approaches or different end states relative to the original August 2002 Savannah River Site (SRS) EM Program Performance Management Plan (PMP). The ESV uses the term "Alternative End States" to remove the perception of any deviation from laws and regulations (Ref. 2).

The SRS ESV is a concise stakeholder's guide to current conditions at SRS and the conditions DOE plans to achieve through the site's EM Clean-up Project. Since the site's EM Cleanup Project is not a static situation, the ESV is continually evolving and improving process and periodic reviews of the end states with stakeholders are planned. The ESV is designed to define and categorize hazards in such a manner that all stakeholders can understand the hazard and what actions are being taken to reduce and/or eliminate the hazard. SRS hazards are organized into five major classes: Nuclear Materials, Radiological Waste, Non-Radiological Waste, Inactive Waste Units, and EM Facilities.

The vision for the end state at the SRS when environmental cleanup is complete by 2025 is that all SRS land will be federally owned, controlled and maintained in perpetuity. SRS is a site with an enduring mission and is not a closure site. Additional missions will continue under National Nuclear Security Administration (NNSA) management.

Comment

The SRS Citizens Advisory Board (CAB) endorses the ESV document and the ESV but points-out while how the Site gets to an end state may change, the end states should be known and should not drastically change over time. As part of the discussions on site hazards and ultimate end-states, risk is defined as the chance of harm or loss. Without a hazard, there is no risk. The SRS CAB believes that any risk-based approach should be applied to the extent possible with existing environmental laws and regulations but as practiced by the Nuclear Regulatory Commission (NRC), any risk assessment should be based upon scientifically determined risks, not risks perceptions. The ESV should define and list all risks associated with the site hazards and include their probabilities estimated for workers, the environment, and the general public. These estimates derived from computer models would help convince the public that a closed SRS site is safe. If proposed cleanup does not sufficiently reduce risk, the public needs to know as well as the remedies the Site will undertake to make the Site safe.

Based upon two recent National Academy of Sciences (NAS) books on DOE's radiological waste

programs (Ref. 3), the SRS CAB supports the idea that the nation needs a formal, well-structured, risk-informed approach. DOE and its regulators should adopt the NAS proposed six step process [(1) initiate the process, laying out viable options and potential decisions; (2) scope the information and analysis; (3) collect data and refine models; (4) prepare refined risk assessments; (5) develop additional analyses to support the decision; and (6) make the decision] for risk-based decisions. The SRS CAB agrees that the biggest challenge to developing a meaningful risk-informed decision-making process is enabling meaningful participation by participants who have limited resources and technical knowledge. One way to help this process would be for DOE to release decision documents to the public at the same time they are released to the regulatory community. It hurts the public trust to discover private vetting of documents before the public sees them, plus it slows down the process, and leads to increased conflict and less acceptance. By having open dialogue with interested stakeholders now, EM and the future Site mission organization (NNSA) could avoid this situation.

An open dialogue is also needed with the general public to help clarify why several low risk facilities are being taken to their end states while higher risk facilities (i.e. reactors, canyons, etc.) are being left alone. In addition, an end state needs to be identified in the ESV for all facilities, especially the reactors and canyons. If the current end-state for the High Level Waste (HLW) (i.e. Yucca Mountain) is delayed, the risk to the public of maintaining HLW in interim storage around SRS should be included in the ESV as well as supporting legal and technical discussions. The SRS CAB would like to see the published disposition schedule for spent fuel and DOE's priority ranking for sending waste if Yucca actually opens. Whether Yucca Mountain opens or doesn't open is critical to the end state.

If DOE, the regulators and the public (consistent with previous statements about involving the public) determine that certain TRU wastes do not need the degree of isolation afforded by Waste Isolation Pilot Plant (WIPP) and that they can be disposed in a non-WIPP location based on a Performance Assessment (PA) that protects the public, the environment, and workers, then DOE should pursue this alternative instead of pursuing methods to overcome TRU shipping disposal obstacles. DOE should fully explain why residential scenarios are being used for low level waste (LLW) hazards if SRS is to remain in Federal ownership in perpetuity. It would help accelerate cleanup of the Inactive Waste Units hazard if site ownership was established by law. The SRS CAB supports formal Congressional Authorization to accomplish this objective but future public access to the SRS should be addressed in the ESV.

The SRS CAB would also like to see the ESV provide the end-state for facilities that once held mixed low level and hazardous waste (Non-Radiological Waste hazards). The Consolidated Incineration Facility (CIF) would be an example.

The SRS CAB recalls the designation of SRS as a National Environmental Research Park several years ago but is concerned about losing this status if no research is being conducted. We believe that this site designation should be discussed in the ESV and the types of current and end state research that could be expected.

The SRS CAB continues to be concerned about the 13 metric tons of plutonium (Pu) with no disposal plans or ultimate end-state. DOE needs to address this hazard as soon as possible.

Recommendation

The SRS Citizens Advisory Board (CAB) offers the following recommendations:

1. In an effort to strengthen the ESV process, the SRS CAB offers the following and expects a progress report on each recommendation on or before September 27, 2005:
 - DOE apply the risk-informed approach proposed by NAS to determine the acceptable end states for all buildings, waste management facilities, reactors and active and inactive waste units containing radionuclides, heavy metals, or organic contaminants (e.g. tritium, etc.).
 - DOE use a risk-informed application to determine the end state for Pu238 waste.
 - DOE release decision documents to the public at the same time they are released for external agency review.

- DOE evaluate the impact to SRS end states and risk to stakeholders if Yucca Mountain doesn't open and consider alternate plans should the repository not open.
 - DOE-HQ identify necessary actions to provide perpetual federal ownership of and responsibility for SRS.
 - DOE-HQ identify necessary actions to formally/legally name SRS as a National Environmental Research Park and discuss the types of current and end state research in the ESV.
2. DOE-HQ investigate and pursue Congressional Authorization to legitimize perpetual federal ownership of SRS and the identification of SRS as a National Environmental Research Park.
 3. DOE use performance assessments to determine risks and provide results to the SRS CAB.

References

1. Risk Based End State Workshop, Strategic and Legacy Management Committee, April 13, 2004.
2. End State Vision Workshop, Strategic and Legacy Management Committee, March 24, 2005.
3. "Risk and Decisions About Disposition of Transuranic and High-Level Radioactive Waste" and "Improving the Characterization and Treatment of Radioactive Wastes for the DOE's Accelerated Site Cleanup Program", National Academies Press, 2005.



©2002 SRS Citizen's Advisory Board. All rights reserved.

Last updated: May 27, 2005



Department of Energy
Savannah River Operations Office
P.O. Box A
Aiken, South Carolina 29802
JUN 28 2005

Ms. Jean Sulc, Chair
Savannah River Site Citizens Advisory Board
24 Harbor River Circle
St. Helena Island, South Carolina 29920

Dear Ms. Sulc:

SUBJECT: Savannah River Site (SRS) Citizens Advisory Board (CAB) Recommendation Number 216 – End State Vision (ESV)

Thank you for your recommendation regarding the SRS ESV. The Department of Energy (DOE) acknowledges your concerns noted in the three-part recommendation and is addressing each part and sub-part, individually.

Part 1: In an effort to strengthen the ESV process, the SRS CAB offers the following and expects a progress report on each recommendation on or before September 27, 2005:

On or before September 27, 2005, DOE will provide a progress report on each of the following recommendations that relates to ongoing or future actions.

- **DOE apply the risk-informed approach proposed by the National Academy of Sciences (NAS) to determine the acceptable end states for all buildings, waste management facilities, reactors and active and inactive waste units containing radionuclides, heavy metals, or organic contaminants (e.g., tritium, etc.).**

DOE recognizes the NAS risk-informed approach and its value in decision making. DOE utilizes those principles in determining end states for various hazards (e.g., the Comprehensive Environmental Response, Compensation and Liability Act risk assessments for soil and groundwater waste units, and performance assessments for radioactive waste management facilities). The NAS recognizes the difficulties and uncertainties associated with risk analysis, and that the results of the risk analysis are only a part of a decision-making process, not the sole basis for the final decision (*Risk and Decisions About Disposition of Transuranic and High-Level Radioactive Waste*, National Academy of Sciences, 2005). Many factors—political, economic, engineering, legal/regulatory, and risks to workers, the public, and the environment—will be considered in determining acceptable end states for all SRS hazards.

- **DOE use a risk-informed application to determine the end state for Plutonium (Pu) 238 waste.**

As DOE evaluates the end state alternatives for Pu-238 waste, DOE plans to use a performance assessment to evaluate the risk of near-surface disposal. Additionally,

DOE plans to review and consider the final National Research Council report (*Risk and Decisions About Disposition of Transuranic and High-Level Radioactive Waste*, National Academy of Sciences, 2005) related to this issue. However, while the decision must be risk-informed, there are other factors that will be considered, as described above.

- **DOE release decision documents to the public at the same time they are released for the external agency review.**

DOE intends to facilitate early community involvement in cleanup decision making under the Federal Facility Agreement (FFA), as stated in the draft *SRS Community Involvement Plan* (May 2005). In this way, the stakeholders can understand cleanup issues and express their preferences for DOE's management of them before decision documents are written. This will allow for informed stakeholder involvement when it can have its greatest effect on decision making. The same approach to early stakeholder involvement will be used for cleanup and end state issues that are not explicitly covered by the FFA.

DOE, as a courtesy, provides pre-decisional documents to DOE Headquarters (HQ) or SRS regulators before releasing them to the public. The SRS ESV document will provide a schematic diagram that depicts the decision process for FFA-related decisions (soil, groundwater, and deactivation and decommissioning) and other end state decisions. The diagram highlights the public involvement milestones and opportunities that are required by law or regulations, or those that DOE will provide to increase stakeholder awareness and allow for informed input.

- **DOE evaluate the impact to SRS end states and risk to stakeholders if Yucca Mountain does not open and consider alternate plans should the repository not open.**

DOE plans to use the repository, as required by law, and does not plan to develop an alternative "what-if" scenario for the related wastes and materials in the SRS ESV document at this time. DOE will continue to address the issues regarding Yucca Mountain and the need for its availability to meet the Performance Management Plan objectives. DOE will provide information to the SRS CAB on waste prioritization and the schedule for the shipment of high level waste and spent nuclear fuel to the Federal repository as it is made available.

DOE is continuing to put tank waste into a stable, retrievable form for temporary storage and shipment to the repository. Spent nuclear fuel will transition from wet to dry storage, a more stable form, in preparation for shipment to the repository.

- **DOE-HQ identify necessary actions to provide perpetual Federal ownership of and responsibility for SRS.**

DOE is working with the End States Working Group to reach agreement on the benefits of and determine what actions are needed to attain perpetual Federal ownership of

SRS. The End States Working Group is a national team of DOE stakeholders and regulators that was chartered by the Office of Environmental Management (EM-1) to provide guidance for a collaborative, periodic review and reevaluation of site-specific end states. The Group will discuss the importance of perpetual Federal ownership to DOE from a national perspective in the next several months.

- **DOE-HQ identify necessary actions to formally/legally name SRS as a National Environmental Research Park (NERP) and discuss the types of current and end state research in the ESV.**

SRS was formally named a NERP in 1972 by the Atomic Energy Commission. It was the first of seven DOE sites to be so designated.

The objectives of the research parks are, and will continue to be, to conduct research and education activities that will:

- Develop methods for assessing and documenting the environmental consequences of human actions related to energy and weapons use;
- Develop methods for predicting the environmental consequences of ongoing and proposed energy development;
- Explore methods for eliminating or minimizing predicted adverse effects of various energy and weapons activities on the environment;
- Train people in ecological and environmental sciences; and
- Use the parks for educating the public on environmental and ecological issues.

NERP-related activities will provide a recognized science base to verify and support the protectiveness and value of remedies, end states, and long-term stewardship activities.

NERP-related research will be addressed in Chapter 1 of the July 2005 ESV.

Part 2: DOE-HQ investigate and pursue Congressional Authorization to legitimize perpetual Federal ownership of SRS and the identification of SRS as a NERP.

DOE is working through the End States Working Group to pursue Congressional Authorization of perpetual Federal ownership. Perpetual Federal ownership of SRS will support the continuous study of the effects of nuclear and industrial operations on the environment, land use management resulting in the protection of largely undisturbed ecosystems, and DOE land-use control credibility. Such ownership must be established in law. DOE will consider pursuing NERP legislation in conjunction with pursuing Congressional Authorization regarding perpetual federal ownership of SRS.

JUN 28 2005

Ms. Jean Sulc

4

Part 3: DOE use performance assessments to determine risks and should provide results to the SRS CAB.

DOE will use performance assessments as required by DOE Order 435.1, "Radioactive Waste Management," to ensure that low level waste disposal facilities meet protective performance criteria. DOE will also discuss with the SRS CAB other appropriate uses for a performance assessment process. Consistent with DOE's desire for early stakeholder involvement in cleanup, the performance assessment results will be made available in time to support early SRS CAB and stakeholder involvement in cleanup or end state decisions.

If you have any questions, please call me or Mr. Brian Hennessey, of my staff, at (803) 952-8365.

Sincerely,

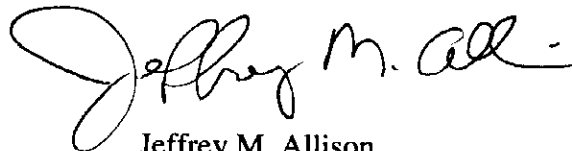
A handwritten signature in black ink that reads "Jeffrey M. Allison". The signature is written in a cursive style with a large, looping initial "J".

Jeffrey M. Allison
Manager

SGP-05-016

PUBLIC COMMENTS ON MARCH 2005 END STATE VISION

#	Comments on March 2005 End State Vision:	Status/Response:
1	<p>Correction Chapter 3.0, page 9, right-hand column, first complete paragraph: Change line 5 to read "...92 USFS-SR FTEs at SRS."</p> <p>According to the notes I find, USFS-SR defines FTEs as Full Time employees; however, I believe it is generally defined to be Full Time Equivalency.</p>	<p>The correction for the number of employees for the USFS-SR has been made to 92 employees.</p>
2	<p>Chapter 1, Figure 1.2: The C-Area bar shows D&D starting before 2006 and yet the Programmatic Agreement took it off the D&D list until 2006.</p>	<p>Figure 1.2 has been corrected.</p>
3	<p>Appendix E: I noted, of significance to me, that "long term stewardship responsibility rests with the site land lord for non closure sites." The CAB is currently circulating a resolution that deals with the turn over of records to the Office of Legacy Management. We should talk to the CAB about it on Thursday.</p>	<p>The long-term stewardship responsibility still rests with the site landlord for non-closure sites. For SRS, Environmental Management (EM) will cease to be the landlord in 2025, transition to National Nuclear Security Administration (NNSA) during 2026 with NNSA assuming full landlord responsibilities in 2026.</p>
4	<p>Appendix B on page 7: I question the advisability of C-Area going to maintenance instead of industrial if we eventually get C-Area open for public tours. This is not a big item and probably not worth changing in the document.</p>	<p>We agree: A statement was added to the third column of the table on Page 7 of Appendix B that read: "For facilities and/or resources that will be preserved and maintained as cultural resources as defined by the National Historic Preservation Act, appropriate land use and exposure scenarios will be negotiated that will accommodate any activities associated with these respective facilities/resources.."</p>
5	<p>Appendix E, Comment 31: There is a statement that the CRMP deals with archeological items. This is not true.</p>	<p>The correction has been made. The response now reads: "For pre-SRS artifacts, the University of South Carolina Institute of Archaeology and Anthropology handles artifacts. For SRS artifacts, DOE is working with several groups, described in Department of Energy Savannah River Operations Office, <i>Savannah River Site's Cold War Built Cultural Resources Management Plan, January 25, 2005.</i>"</p>
6	<p>Overview - Extend the public comment period date to the May CAB meeting or address the potential CAB recommendation that will be generated at the May CAB Meeting.</p>	<p>The CAB recommendation was considered in revising the final document. Final document submittal was delayed to accommodate CAB Recommendation 216 in May 2005.</p>

#	Comments on March 2005 End State Vision:	Status/Response:
7	Overview - Concerned why tritium was included as a hazard since the tritium mission is with the National Nuclear Security Administration.	The <i>End State Vision</i> (ESV) covers the entire site and all programs – not just EM.
8	Overview - The risk basis approach should be applied to the extent possible in addition to laws and regulations. The legal statutes are based on risk perceptions and not risk.	Most regulatory frameworks do consider risk in establishing cleanup requirements. The assumptions by which risk is estimated are sometimes conservative, but some flexibility to adapt them to more representative exposure scenarios does exist. Stakeholder review of risk assumptions in end state planning evaluations is valuable in this regard.
9	Overview - Concerned that there is emphasis on the changing of the end states when many of the end states are known. How the site gets to the end state may change, but the end states should not change.	<p>The <i>End State Vision</i> presents the planned end states for all of the hazard categories, and a rationale for them based on existing or reasonably anticipated disposition options. They are not tentative or conjectural, but are based on realistic assumptions. These planned end states are the objective of all EM work at SRS.</p> <p>The end states for some individual facilities may change in response to mission needs or further analysis of Decontamination and Decommissioning (D&D) alternatives. External events or the availability of better or more protective disposition options may cause planned end states to be re-evaluated in the future. However, that does not mean that planned end states are fluid or tenuous—only that DOE will be continually seeking better, more cost-effective ones.</p>
10	Overview - Was shocked at Chapter 4 relative to lack of inclusion of risk relative to the workers and the public. This risk should be addressed. Need to address residual risk to workers and the public in one document, which should be the End State Vision. This version is not an improvement over the previous draft in relation to the discussion on risk	It is not practical for the <i>End State Vision</i> to include a comprehensive discussion and analysis of risks from all sources. Rather, the risks from each source, and aggregate risk from sources within an area, will be modeled at the appropriate time, with ample stakeholder review, for decision making. That time will be the beginning of planning/scoping for facility deactivation/decommissioning or area completion, or another event that necessitates detailed end state planning, such as an alternative disposition option for a hazard or facility.
11	Overview - Concerned that low risk buildings are being taken down when higher risk buildings should be considered.	The planned end state is for all EM facilities to be decommissioned by 2025. Nuclear facilities will be decommissioned at a time and in a manner that supports the SRS Area Completion Strategy.
12	Overview - Need to provide the appropriate calculations that convince the public that SRS sites are safe. If cleanup is insufficient, the public needs to know now. The site has been silent on the 100 and 200 areas.	Chapter 4 of the ESV provides that current and projected Soil and Groundwater Projects (SGP) end states will accommodate final risk levels appropriate for the exposure scenario for the expected land use. SGP cleanups that have already been completed have met all applicable

#	Comments on March 2005 End State Vision:	Status/Response:
		<p>standards including protectiveness of human health and the environment which is documented (with appropriate calculations provided) in the Administrative Record supporting those cleanup decisions. Future SGCP cleanups will follow the identical process/protocol.</p> <p>Operating facilities and waste management facilities operate in accordance with applicable federal and state laws, DOE Orders, and the controlling documents listed in Chapter 4 for each hazard category, to ensure protection of human health and the environment.</p> <p>The completion and subsequent end states for the 100 and 200 areas will be addressed per the FFA and the schedule provided as Figure 1.2, <i>Critical Decision Path to Area Completion</i>.</p>
13	<p>Overview - Concerned there is no end state for the reactors and canyons. R-Reactor was shut down 30 years ago. The site ought to know what the end state is by now.</p>	<p>End states for nuclear and radiological facilities will be consistent with area future use, and will be determined considering the factors in ESV Section 4.2.11, <i>Nuclear and Radiological Facility End State Evaluation and Decision-Making</i>. Reactor and canyon facilities will be decommissioned in situ, not demolished, and the details of that end state will be determined, with stakeholder review, in the scoping process as their respective area completion projects begin.</p>
14	<p>Plutonium, Uranium and Spent Nuclear Fuel - Is there a published disposition schedule for spent fuel and DOE priority at Yucca Mountain?</p>	<p>A formal disposition schedule has not been published, but thermal concerns at the repository will require DOE materials (liquid radioactive waste [LRW] and spent nuclear fuel [SNF]) to be available shortly after the repository opens.</p>
15	<p>Plutonium, Uranium and Spent Nuclear Fuel - The risk to stakeholders should be stated in the document if Yucca Mountain doesn't open. Legal, public and technical support should be included in the document if Yucca Mountain doesn't open.</p>	<p>The federal repository is the planned disposition for several categories of hazards at SRS. Therefore, alternative dispositions and their associated short- and long-term risks have not been developed. Before any alternative to shipment to the federal repository is considered, risks and benefits will be carefully evaluated with full stakeholder involvement and review.</p>
16	<p>Plutonium, Uranium and Spent Nuclear Fuel - An analysis of terrorism should be included.</p>	<p>DOE facilities currently operate under the latest threat guidance available. As new guidance is issued, our security posture changes accordingly.</p>
17	<p>Liquid radioactive waste - The Defense Nuclear Facility Safety Board (DNFSB) has a question on the safety classification of the Caustic Side Solvent Extraction (CSSX) and Actinide Removal Process (ARP). The CAB also has a</p>	<p>The Department of Energy considers the ARP and Modular Caustic Side Solvent Extraction Unit (MCU) to be vital parts of our interim salt processing strategy. These facilities allow SRS to remove significant quantities of radionuclides from salt waste that will be processed between</p>

#	Comments on March 2005 End State Vision:	Status/Response:
	recommendation on these two facilities. Should DOE drop these two facilities?	2006 and the startup of Salt Waste Processing Facility (SWPF). Further it minimizes the quantity of radioactive material disposed in South Carolina. SRS will continue to design, construct, and operate these facilities.
18	Liquid Radioactive Waste - Dilute low activity salt is the best way to free up space in the tanks.	The Deliquification, Dissolution, and Adjustment (DDA) process involves the following steps: 1) Selection of the tanks containing the lowest curie content salt waste, 2) Removal of a portion of the cesium-bearing interstitial liquid, 3) Dissolution and transfer of the salt cake followed by settling of insoluble radionuclides, 4) Adjustment of chemistry to meet Saltstone Waste Acceptance Criteria (WAC) limits, and 5) Processing into grout for disposal. Under the interim salt processing strategy, approximately 7 million gallons of salt waste (out of an estimated 84 million total) will be treated in this manner. This quantity coupled with material processed by ARP and MCU will be processed prior to the startup of the SWPF in 2009 after which all salt waste will be processed via SWPF.
19	Liquid radioactive waste - The public has not heard of the closure of Saltstone and what are the end states of the vaults.	Saltstone vaults will have a closure cap installed at the end of the salt waste disposal program. This cap is described in <i>Saltstone Disposal Facility Closure Cap Configuration and Degradation Base Case: Institutional Control to Pine Forest</i> , WSRC-TR-2003-00436, Phifer and Nelson.
20	Liquid radioactive waste - Where does the public become involved with the performance based analysis?	SRS plans on revising the Performance Assessments for Saltstone in FY06 and for E-Area in FY07. We do not normally hold a public meeting for these documents. However, we do normally inform the CAB's Waste Management Committee when these activities take place and when the documents will be available. SRS will provide the CAB and/or Waste Management Committee a briefing on these documents upon their request. SRS has provided the CAB numerous briefings in the past on disposal activities at the site that would affect the Performance Assessment.
21	Liquid radioactive waste - It would be great if the appendix of the End State Vision (ESV) document had a flow chart that shows how and when the public becomes involved in closing facilities and areas.	A description of key factors in Facility End State Evaluation is presented in section 4.2.11, <i>Hazard: EM Facilities</i> . Public involvement is discussed there, as well as in Chapter 1 (see Figure 1.3, <i>Basic Area Completion Process</i> and in the <i>SRS Community Involvement Plan</i> (May 2005). DOE recognizes the importance of public review of the

#	Comments on March 2005 End State Vision:	Status/Response:
		assumptions and methods associated with facility end state decisions.
22	Liquid radioactive waste - What methodology was used to determine how clean the facilities/tanks are? What was the thought process? How is that handled?	Samples are taken and analyzed to determine if heel removal is done on a specific tank. The volume remaining in the tank is estimated and used as a source term for performance modeling. The contribution of the tank performance is added to the estimated or analyzed performance of the other tanks and facilities to ensure regulatory limits will not be exceeded.
23	Liquid radioactive waste - Recommend the public become involved at the time the site deems tanks are clean enough in order not to stall the effort in the future.	The process for determining if the tanks are clean enough for onsite disposition, including environmental impacts will be open to the public.
24	Liquid radioactive waste - The South Carolina Department of Health and Environmental Control (SCDHEC) has a copy of the closure plan but why doesn't the public? The public didn't get a copy of the Waste Determination Document before it is released. When the document leaves DOE, the public should get a copy.	When DOE provides a draft waste determination to the Nuclear Regulatory Commission (NRC), the public will also be provided a copy for review and comment. Following NRC and DOE consultation on the Waste Determination (WD), DOE shall submit a closure plan to SCDHEC which will also undergo public review.
25	TRU Waste - Is there a process for newly generated TRU Waste?	Currently generated TRU waste from EM missions at SRS is packaged to meet the Waste Isolation Pilot Plant (WIPP) waste acceptance criteria and is shipped concurrently with the legacy TRU waste. EM-generated TRU waste is expected to be completed in the timeframe the legacy TRU shipments are completed. Newly generated TRU waste beyond the EM missions will come from future missions currently planned to be managed by NNSA. Future NNSA missions at SRS have not been finalized at this time.
26	TRU Waste - The safe storage alternative for Pu238 should be pursued now, not after all the other TRU waste is shipped out.	As discussed at the ESV Workshop, DOE currently plans to ship all legacy TRU waste to WIPP by 2011 and does not need to pursue any on-site disposal or long term storage alternatives at this time.
27	TRU Waste - Is the schedule for shipment of TRU waste realistic?	The current shipping schedule is based on the DOE Complex availability of WIPP shipping resources and projected outyear funding for SRS. These are subject to change and could impact SRS abilities to execute the current shipping schedule.
28	Low Level Waste - Who makes the decision to ship LLW to Nevada or Envirocare?	Westinghouse Savannah River Company (WSRC) makes the decision to send waste to Nevada Test Site (NTS) or Envirocare. This decision is normally based upon the cost of disposal and meeting the respective Waste Acceptance Criteria of the disposal facility.

#	Comments on March 2005 End State Vision:	Status/Response:
29	Low Level Waste - DOE has promised to set aside the lands of SRS and ensure that they will remain under governmental control forever. I expect that these controls will not be forever thus SRS should evaluate the risk of unrestricted residential use to identify that risk and show where on SRS unrestricted residential is unacceptable.	The risk under unrestricted use is estimated during the cleanup decision (baseline risk assessment) process. Land use restrictions are included in Records of Decision when unrestricted use would have unacceptable risk. These restrictions are listed in the <i>Land Use Control Assurance Plan for the Savannah River Site</i> .
30	Low Level Waste - Is there a program in place to continually monitor LLW vaults?	Yes. The vault sumps are monitored for any liquids that might accumulate in the sumps monthly or after a rain of 2 inches or more. This liquid is sampled for any radionuclide content and disposed of as appropriate. The vaults are also monitored on a yearly basis for any cracking or subsidence issues..
31	Mixed Low Level and Hazardous Waste - What are the end states for the facilities that once held waste that was shipped off-site?	These facilities will be closed according to RCRA requirements, in accordance with a state-approved closure plan.
32	Soil and Groundwater Remediation - Site ownership should be established by law.	The site has proposed to DOE-HQ that legislation should be proposed that SRS property remain under federal ownership in perpetuity.
33	Soil and Groundwater Remediation - Ownership should assume future public access. Should be evaluated now.	Access to the site is being determined on an area by area basis, according to the specific regulatory agreements determined with each area completion.
34	Soil and Groundwater Remediation - What is going to be your record keeping in future years?	The FFA requires that DOE preserve the complete Administrative Record, including post-Record of Decision primary and secondary documents and reports, for at least ten years after the termination and satisfaction of the FFA. The Administrative Record contains all documentation supporting the cleanup decisions made and implemented under the FFA at SRS.
35	Soil and Groundwater Remediation - The public has been told SRS land use restrictions will not be placed in County Deeds until DOE relinquishes control of the lands. These restrictions should be included in County records as soon as Records of Decision has been completed so County and the public will see the needed restrictions.	The land use restrictions included in RODs for protectiveness are mandated by CERCLA and are not required to be placed in a deed until the property is sold. As such, there is no requirement that DOE place the restrictions in the deeds at this time. Also, at the time of any eventual transfer, the restrictions may or may not still be necessary. Further, since SRS comprises over 1500 individually deeded parcels, matching the restrictions with the right deed would be very time-consuming and of little benefit, since those individual parcels no longer exist but now form the SRS.

#	Comments on March 2005 End State Vision:	Status/Response:
		DOE will consider placing a simple notice of the land restrictions on the public record at each county's Register of Deeds. Also, on the matter of notice, while DOE has a statutory requirement to place the land use restrictions in a deed at the time of sale, the buyer also has its own due diligence obligation to research the history of the property for, among other things, environmental issues that might be of concern on the property. If a proper due diligence review is undertaken, any potential buyer would be able to discover the past use of the property and what land use restrictions would be applicable. Further, all the land use restrictions applicable to the site already exist in the <i>Land Use Control Assurance Plan for the SRS</i> , which should be publicly available and/or subject to Freedom of Information Act request.
36	General Discussion - Are the conclusions in the Performance Assessment and the end state document consistent?	The end state described for DOE's low-level waste management facilities is consistent with the end state assumed in the performance assessment.
37	General Discussion - What are the plans for off-site disposal of the 13 metric tons of plutonium (Pu) with no disposal plans?	DOE is currently evaluating several options for this material including Pu Vitrification and processing in H-Canyon.
38	General Discussion - When will we get a response to the questions asked today?	This question was asked at a workshop held on March 24, 2005. Comments from the workshop and other comments received are included in this Comment Response Matrix.
39	General Discussion - Concerned because I don't see any effort to ensure the government will fund the actions in the End State Vision.	The life-cycle scope and cost to complete the site's EM cleanup mission by 2025 have been validated and are annually audited independently. DOE is committed to requesting the necessary funds from Congress.
40	General Discussion - At one time the site was made a National Environmental Research Park. Is environmental research continuing at the site?	SRS is and will continue to be a National Environmental Research Park. Environmental research on SRS is ongoing, and is conducted by multiple organizations on-site, including SRNL, SREL, and the USFS. Please refer to Section 1.6, <i>National Environmental Research Park</i> , for additional information.
41	General Discussion - Need to ensure monitoring results from SRS are perpetual and available to the public.	Monitoring will continue as required by the FFA and DOE-HQ. Current plans are to continue to publish the <i>SRS Annual Environmental Report</i> , which provides all monitoring information, including all data.
42	Additional Comments - Recognizing that at the present time, the site can't do a "what-if" evaluation of every nuclear facility and its residual nuclear material after deactivation (to	A description of key factors in Facility End State Evaluation is presented in section 4.2.11, <i>Hazard: EM Facilities</i> . Public involvement is discussed there, as well as in Chapter 1 (see Figure 1.3, <i>Basic Area</i>

#	Comments on March 2005 End State Vision:	Status/Response:
	determine how much material could be safely left after decommissioning), but it would be of great value to describe HOW that evaluation will be done when it's time: What factors will be considered (what receptor, pathway), what time frame analyzed, what regulations or standards applicable, and (importantly) when/how the public will be involved in these facility end state decision. A tentative timetable for the completion of the evaluation for each nuclear facility should be provided.	<i>Completion Process</i>) and in the <i>SRS Community Involvement Plan</i> (May 2005). DOE recognizes the importance of public review of the assumptions and methods associated with facility end state decisions.
43	Additional Comments - Requested that; material DOE has decided to use EPA 40CFR191 performance objectives for TRU waste at SRS – if DOE and EPA (SCDHEC) determine that the TRU wastes do not need the degree of isolation afforded by Waste Isolation Pilot Plant (WIPP), they can be disposed in a non-WIPP location based on a Performance Assessment (PA) that protects the environment and workers.	Non-WIPP disposal of TRU wastes, based on performance assessment, that do not need that degree of isolation is an alternative end state described in Appendix B, <i>Alternative End States</i> . It will be evaluated in accordance with appropriate regulations and DOE Orders, with stakeholder review, in ample time to support a decision. The current plan for this material is disposal at WIPP.
44	Additional Comments - I understand that the PA – Composite Analysis (CA) modeling by Tetrattech is different from Jim Cook and Elmer Wilhite; Are the primary Constituents Of Concern the same? Are the threats to humans the same? Can you provide us with a comparison?	Although tank closure performance modeling and composite analysis modeling are done under different models, both evaluate constituents of concern for public and environmental impacts. All applicable performance modeling shall be available for public review during the WD process as well as the SCDHEC permitting closure plan approval process
45	Additional Comments - In an earlier motion (#155) CAB asked DOE to consider revising the lower limit of TRU waste definition based on risk; we understand that DOE has.	DOE has not changed the lower limit for TRU waste nor has any plans to change the definition of TRU waste
46	ES 2.11, p.6 - Under "next steps" at SRS are to: last bullet reads: "Amend the Core Team process with the regulators to establish an End State Core Team to ensure proactive regulatory involvement for measuring end state progress, evaluation of AES opportunities, long-term stewardship transition and monitoring area closure. : <i>such End State Core Team to include at least one representative from the Citizens Advisory Board or similar public entity and an alternate representative.</i> " Italics is the addition and recommendation - such a presence	The Core Team—those DOE, SCDHEC, and EPA representatives making cleanup decisions—wants to know the views, desires, and preferences of stakeholders early in the decision-making process. Examples include, in the consideration of future use and exposure assumptions that will guide risk assessment, the range of response actions that should be considered, and the end state that should be achieved. A framework for this stakeholder review and participation is in the <i>SRS Community Involvement Plan</i> (May2005). DOE is also committed to annually reviewing end states with stakeholders, continuing the comprehensive planning process that began in 1995 and recognizing that

#	Comments on March 2005 End State Vision:	Status/Response:
	would establish a precedent in the early stages of transition (or whatever issue) of including a CAB representative's in the process of the ESV evolution or for that matter other Core Team deliberations.	new disposition alternatives may arise.
47	<p>Comment: Portions of the SRS for which the federal government has no foreseen federal mission should be dispositioned in accordance with federal law including restoration to a hazard level that would permit unrestricted use by the state of South Carolina or by its citizens. Small portions of the site where cleanup to this level is not economically feasible may be cleaned to a lesser degree and maintained under the control of the federal government. The expectation should be that more than 90% of the site should be restored to a level that permits unrestricted use and these portions should be returned to the State accordingly.</p> <p>Justification: The SRS is a federal asset with great potential to meet the needs of the nation. It is also a great asset of the State with potential to be part of a technical foundation for future economic benefit. It is right and fitting that the federal government maintains control of the SRS and that the state of South Carolina continue to permit such control for the benefit of the nation to the extent that the federal government states and pursues a national mission for the site. Portions of the site not required for federal/national missions should be restored to the State so that they may be used for the economic benefit of the State and the nearby portions of the state of Georgia.</p>	<p>Since the issuance of CAB Recommendation #8, Future Land Use, in 1995 and the <i>SRS Future Use Project Report</i> in 1996, SRS stakeholders have consistently expressed the desire that SRS remain the property of the federal government. Most of the SRS land is not contaminated; there is no contamination-related restriction on use in those uncontaminated areas. However, there is no plan to relinquish control or convey ownership of SRS land to the state or any other non-federal entity.</p>
48	<p>Comment: Alternate end states #1, Future Land Use and Exposure Scenario Modification, and #3, In-situ Decommissioning in lieu of Demolition, should be used sparingly, if at all, in conjunction with long-term federal control of these particular areas. The total area designated for these end states should be less than 5% of the total site area, and should not impact the economic viability of the remaining 95% of the site.</p>	<p>As stated in response to the previous comment, there are vast tracts of SRS land that are suitable for industrial uses that are consistent with the site's mission. In-situ decommissioning of facilities in lieu of demolition will have no effect on those areas.</p>

#	Comments on March 2005 End State Vision:	Status/Response:
	<p>Justification: The SRS is a great national and state asset that can and should be an engine for regional economic growth and should help the nation solve its pressing problems in national security, energy security and environmental management. The total developed land area at the SRS is less than about 10% of the total available land area. Of this amount, it is reasonable to assume that less than half represents the buildings and areas for which total restoration would be economically infeasible. It is unreasonable to expect the nation or the entire state to accept a continuing economic liability with regard to the entire site for the sake of this small total portion of the site. A reasoned and appropriate remediation plan should permit sound economic decisions concerning these small, problematic areas while permitting the majority of the site to be available for other use, preferable unrestricted.</p>	
49	<p>We continue to encourage DOE-SR to more fully integrate into SRS site management, planning, and reports such as the ESV applicable historic presentation mandates, agreements with our office, as well as legacy issues related to the preservation and interpretation of SRS historic properties, artifacts, and cultural resources. Integration of historic preservation and interpretation concerns into current and future planning, management, and decision making is crucial to the education of SRS personnel and the public at large, the prevention of adverse incidents, and the survival of SRS's valuable historic resources.</p>	<p>DOE has fully integrated historical preservation planning into the site D&D and Operational and Maintenance planning processes to ensure that all Cold War historical resources are properly managed prior to any undertaking that could potentially impact the historic character of any Cold War historic SRS facility.</p>
50	<p>Acronyms, p.2: "SHPO" should be, State Historic Preservation Office, or alternately, can use "SC-SHPO" = South Carolina State Historic Preservation Office. (This mistake occurs elsewhere in the ESV, for example, Chapter 4, p. 30.)</p>	<p>This change was made throughout the document.</p>
51	<p>Executive Summary, p.7: Reference 11, add "Environment" to the CRMP title. (This mistake occurs elsewhere when referencing the CRMP, for example, Chapter 4, p.45.)</p>	<p>This change was made throughout the document.</p>

#	Comments on March 2005 End State Vision:	Status/Response:
52	Chapter 1, p.2: bottom right: The CRMP's summary needs rephrasing. We suggest "...applies only to the Site's Cold War National Register of Historic Places (NRHP)-eligible historic properties and...."	This wording was changed as suggested.
53	Chapter 1, P. 5-6: We recommend adding "Stewardship" mission(s) for cultural resources, natural resources, and/or historic preservation and interpretation. These missions, however, "non-core" they may be considered, are inclusive of the definition of stewardship and are immensely applicable to DOE-SR's management of the land under their ownership and the legacy that the Site will leave. Their importance should be reflected in the ESV and not just referenced in other SRS reports.	These missions were taken directly from the <i>SRS Strategic Plan</i> for consistency. If the <i>SRS Strategic Plan</i> is changed to reflect your suggestions, we will change the ESV.
54	Chapter 4, p.30, top paragraph: change end of last sentence, first paragraph, to "...within a NRHP-eligible SRS Cold War Historic District." Note: We would love for DOE to submit a National Register nomination for a SRS Cold War Historic District. Until then, however, it is misleading to use language stating there is a historic district, when one has only determined to be eligible for the NRHP.	The wording was changed to reflect your comment.
55	Chapter 4, p.30, second paragraph: change "Was" to War, and "SRHP" to NRHP.	These changes were made.
56	Appendix F: Here and elsewhere where references are noted it would be helpful to provide a research location or contact for where these items may be found and perused. Providing web links to documents, etc. available online would also be helpful.	Many of the references are not available on the internet; however, when they could be found on the internet, the URL was added to the reference. Also, the names of agencies or groups, when appropriate, were provided to facilitate where these documents can be found.
57	Appendix H, Public Comment Matrix: The inclusion of the matrix is helpful as a forum. However, we do not agree that our previous comments/concerns, as responded to in the matrix, are address in full by the CRMP or agreements between our office, DOE-SR, and consulting parties. The CRMP itself notes the importance of education and integration of historic preservation concerns into future	DOE leads the SRS Cold War Heritage Tourism Team, comprised of those consulting parties from the Programmatic Agreement and the CRMP. This team meets quarterly to seek ways to enhance public involvement, outreach, and education in Cold War heritage tourism. Meetings have been held in various museums and centers within the Central Savannah Regional Area.

#	Comments on March 2005 End State Vision:	Status/Response:
	decision making and planning.	
58	<p>A good document with lots of useful information. What I did not see was a specific listing of "orphaned" waste (or whatever the appropriate term is for that stuff - waste without a pathway to disposal). In my humble opinion, there is too much "orphan" waste to ignore or simply lump into a single pot and say "this will be addressed later as an Alternative End State."</p> <p>Waste which does not have an approved pathway (no equipment for processing, no way to prepare it for WIPP approval, no approved way to get it from its current state into an approved container, etc.) needs to be specifically identified by type, location, volume, etc. Perhaps something could be added concerning potential alternatives. - 1. build a \$400m piece of equipment capable of safely crushing it into an appropriate size. 2. disposal on site. 3. Pouring 3 feet of concrete all around it, etc. This is the only way the stakeholders will be able to begin to grasp the scope of problem and see the things that might get in the way of an "ideal" ESV.</p>	<p>DOE Order 435.1, <i>Radioactive Waste Management</i>, specifically states that the sites are to identify and the Site's Manager approve any waste that does not have a path for disposal. SRS has identified several wastes in this category, and we have continued to reduce the amount of waste on this list over the years. <i>The System Plan for Solid Waste Management</i> specifically identifies this waste along with the quantity of waste to be disposed. The <i>System Plan</i> is revised every year to update the treatment and disposal alternatives for these and other waste streams. SRS will continue to reduce the amount of waste on the "waste with no path for disposal" list through technology development or innovative disposal methodologies.</p>



SRS Citizen's Advisory Board

Savannah River Site Citizens Advisory Board

Recommendation 190 Risk Based End State Vision Document

Background

The principles of the Department of Energy's (DOE) Top-to-Bottom Review have transformed the Office of Environmental Management (EM) purpose from simply managing risk to accelerating risk reduction by expeditiously cleaning up the Cold War legacy. A cornerstone of this effort is the development of a site-specific Risk-Based End State (RBES) Vision document for each DOE site, pursuant to DOE Policy 455.1, *Use of Risk-based End States*, and other associated guidance.

RBES and its documentation in an associated RBES Vision document depict appropriately protective and sustainable site conditions, by which current regulatory and other parameters can be described, evaluated, and contrasted. This is not a decision document; rather, it is intended to support informed decisionmaking regarding responsible site cleanup. The Program Performance Management Plan (revised), however, is a definitive decision "path" to the Savannah River Site (SRS) end state. Therefore, the two documents are closely linked. Development of a RBES Vision and identification of potential variances from a current end state do not signal an intent to perform less cleanup, nor to pursue shortcuts around current laws, regulations, or agreements. Furthermore, while a RBES approach may ultimately reduce cleanup costs, the RBES Vision is not driven by cost considerations.

The new vision for the end state at the Savannah River Site (SRS) when environmental cleanup is completed by 2025 is that all of SRS land will be federally owned, controlled and maintained in perpetuity. SRS is a site with an enduring mission and is not a closure site. Additional missions will continue under the National Nuclear Security Administration (NNSA) management. SRS has identified five RBES variances, which are defined as a significant different cleanup approach or different end state relative to the original August 2002 SRS EM Program Performance Management Plan (PMP). These variances include (1) future land use and exposure scenario modification, (2) area risk methodology and protocols, (3) alternate disposal for Pu-238 contaminated waste, (4) in situ decommissioning in lieu of demolition, and (5) "glass durability" waste acceptance criteria for high level waste (HLW) federal repository (Ref. 1).

Comment

The SRS Citizens Advisory Board (CAB) endorses the RBES concept and the SRS End State Vision. The SRS CAB supports the use of minimum risk based end states protective of human health and the environment as long as best engineering and science can support them. The SRS CAB realizes that SRS will have a degree of contamination remaining at specific sites after the cleanup is complete in 2025. However, the perceived risk to human health and the environment from these sites may be quite different from the actual risks. The SRS CAB is concerned that the general public's lack of information will negatively affect the public's ability to discern the difference. Any outreach education effort to the general public needs to be at an understandable level with clear "common sense" examples and avoid the use of technical jargon and acronyms.

The SRS CAB is also concerned about the potential barriers to RBES success and the five RBES variances. Of major concern is the HLW classification issue and alternative disposal for Pu-238 contaminated waste. Both issues present the site with significant risk challenges. The SRS CAB was interested in reducing this risk by adopting Recommendation #155, which requested alternative disposal paths to the Waste Isolation Pilot Plant (WIPP) that are environmentally acceptable and without increased risks to SRS workers or the public. Some CAB members and the general public heard a brief discussion of these options at the National Academy of Science Committee on Risk Based Approaches for Disposition of Transuranic (TRU) and HLW on January 28, 2004, and think they are worth pursuing further. The SRS CAB, through individual committees, may later provide specific recommendations concerning these issues and variances.

Recommendation

The SRS CAB offers the following recommendations in an effort to strengthen the RBES process and expects a progress report on each recommendation on or before September 27, 2004:

1. SRS provide additional information about the risks, both human health and environment, associated with the end states proposed.
2. SRS clearly articulate the plan and approach for reaching public acceptance of the end state visions.
3. SRS develop a RBES outreach effort to educate the general public on the difference between perceived risks to human health and the environment and actual risks associated with SRS end states.
4. Regarding future land use, DOE-SR and DOE-HQ pursue Congressional Authorization to provide perpetual federal ownership and responsibility for SRS's fixed boundaries.
5. SRS include a discussion on how historic preservation, cultural resource management (CRM) goals, and continued National Environmental Research Park (NERP) designation are integrated into the SRS end state vision and how SRS will implement them.
6. SRS evaluate alternative disposal options for Pu-238 contaminated waste so that the risks associated with handling and shipments are protective of human health and the environment.
7. SRS continue to develop "area" risk assessment methodology and protocols protective of human health and the environment.
8. SRS determine and evaluate the risks of in situ decommissioning in lieu of demolition.
9. DOE-HQ request and work with the Nuclear Regulatory Commission to revise the HLW federal repository glass durability specifications to allow an increase in waste activity loading above the current specifications.

References

1. Risk Based End State Workshop, Strategic and Legacy Management Committee, April 13, 2004.

Agency Responses

Department of Energy-SR



©2002 SRS Citizen's Advisory Board. All rights reserved.

Last updated: September 14, 2004



Department of Energy
Savannah River Operations Office
P.O. Box A
Aiken, South Carolina 29802

JUL 21 2004

Ms. Jean Sulc, Chair
Savannah River Site Citizens Advisory Board
24 Harbor River Circle
St. Helena Island, SC 29920

Dear Ms. Sulc:

SUBJECT: Savannah River Site (SRS) Citizens Advisory Board (CAB) Recommendation 190 – Risk-Based End States (RBES) Vision Document

Thank you for your recommendation regarding the draft *SRS RBES Vision Document*. The Site continues to pursue accelerated risk reduction and completion of the Environmental Management (EM) cleanup mission at SRS. The draft *SRS RBES Vision Document* is a critical tool in this effort, in that it defines appropriately protective and sustainable Site conditions at the end of that mission. The Department of Energy (DOE) developed the draft *SRS RBES Vision Document* using a tailored approach for the data requirements. This approach was adopted to be consistent with the area closure strategy recently agreed upon with our regulators and reviewed with the public through the SRS CAB. DOE is committed to a continuous planning process and is accountable for execution of the EM cleanup mission at SRS using a risk-informed approach.

The SRS CAB recommendation comprises nine parts, each of which I would like to address:

Parts 1, 3, 6, and 8 all deal with the determination of risks at SRS and how those risks can be better shared with the public and stakeholders.

– The revised (“final”) *SRS RBES Vision Document* will include additional information on the human health and environmental risks associated with the Site’s currently planned end states and potential alternative end states for each of the hazard types at SRS, including EM facilities to be decommissioned and plutonium-238 contaminated wastes. Risk balancing (that is the risk reduction achieved by an action, as compared to the risk involved in taking the action, or other trade-offs) will be considered and discussed as well. As we progress with the cleanup of hazards by area at SRS, more information about these hazards will be obtained, and more detailed risk assessments will be developed where appropriate. Progress and issues will be discussed with the SRS CAB through periodic Board and committee meetings. The difference between perceived risks and actual risks will be discussed in the final *SRS RBES Vision Document* and will be a topic of the presentation on risk that DOE will develop for the public.

Part 2 asks that DOE clearly articulate the plan for reaching public acceptance of the RBES vision.

– The *SRS RBES Vision Document*, as an examination of the planned end states and possible alternatives to be achieved by the SRS cleanup program, will be an ongoing process that will involve SRS’s regulators and the public. New cleanup alternatives may arise in the future that will make it possible to realize protective and sustainable end states that have not been proposed or evaluated before.

The first phase of that process has been public and regulator input to the draft *SRS RBES Vision Document*. That input occurred in meetings with regulators, in the public workshop hosted by the CAB, and during a public comment period that ended in May. DOE's plan to promote public acceptance of the final RBES vision is to continue to work with our regulators and to inform the public as we determine appropriate end states. Within the regulatory framework, end states involve decisions that require negotiation with our regulators and public notification and involvement. We will also continue to inform the public through the SRS CAB and other public forums such as Environmental Justice meetings. In addition, DOE has determined that additional public participation is appropriate before finalizing the document in December of this year. A workshop will be conducted on October 5 – 6, 2004, to discuss the next steps in the risk-based end state process. The workshop will be conducted with assistance from the National Governors Association and details of the workshop will be provided when a location and agenda are determined.

Parts 4 and 5 deal with integration of risk-based end states, future land use, historic preservation, and environmental research.

– DOE is considering additional surety of future land use by pursuing Congressional authorization creating perpetual Federal ownership and responsibility for SRS. This initiative is in the early stages of planning. The final *SRS RBES Vision Document* will include a discussion of the integration of historic preservation, cultural resource management, and the Site's National Environmental Research Park status. Also the SRS RBES vision will be factored into updates to the SRS Comprehensive Plan including the Future Use Plan.

Part 7 deals with DOE's pursuit of area risk methodology and protocols to support the area closure strategy.

– DOE agrees to continue to work collaboratively with our regulators and stakeholders to develop an effective and efficient methodology for assessing risks on an area scale. This initiative advances accelerated cleanup decision-making and remediation at SRS.

Part 9 concerns efforts to increase waste activity loading by revising High Level Waste (HLW) Federal Repository glass durability specifications.

– DOE will continue to collaborate with the Nuclear Regulatory Commission, National Academies, and other associated parties to effect a change to the Federal Repository's specifications for HLW glass durability that would enable SRS to increase waste activity loading at the Defense Waste Processing Facility.

Again, we appreciate your interest in this effort, including your willingness to host a workshop dedicated to discussing the *SRS RBES Vision Document* with the SRS CAB and other stakeholders. This process of public participation adds value in building broad support for cleanup objectives that are protective, sustainable, and consistent with the future use of SRS.

Ms. Jean Sulc

3

JUL 21 2004

DOE is in the process of finalizing the *SRS RBES Vision Document* to address public comment. The final document is scheduled to be issued in December 2004 following completion of a national workshop in October that will be conducted with assistance from the National Governors Association.

If you have any questions, please contact me or have your staff contact Mr. Tony Polk at (803) 952-8394.

Sincerely,

A handwritten signature in black ink that reads "Jeffrey M. Allison". The signature is written in a cursive style with a large initial "J" and "M".

Jeffrey M. Allison
Manager

EB-04-017

APPENDIX H
PUBLIC COMMENTS ON MARCH 2004 RISK BASED END STATE VISION

#	Comments: on the March 2004 Risk-Based End State Vision	Status/Response:
1	Asked for a formal extension of time for public comment so that any CAB motion could be presented to the full board for consideration and so that the recommendation could be part of the final Savannah Rive Site (SRS) policy.	Public Involvement comment period extended to May 21, 2004, per request.
2	In DOE Order 435.1, risk is not defined. It should be defined in the RBES.	Risk definition Department of Energy (DOE) Order 435.1 (Radioactive Waste Management). <i>End State Vision</i> (ESV) Section 1.3.1 defines risk and how it is applied in the SRS ESV. Additional information on risk can be found in Appendix G, <i>Land Use, Risk and Cleanup Decision Process</i> The ESV differentiates between “hazards” (source terms) and “risks” and between “contained hazards” and “released hazards”. SRS is preparing a "civic club-type" presentation to communicate risk concepts and methods.
3	Is "in perpetuity" DOE-Headquarters (HQ) guidance?	No. The perpetual federal ownership of SRS fixed boundaries is an SRS recommendation and is supported by SRS regulators and CAB. The SRS ESV recommendation formalizes the request. There is a draft action in the DOE-HQ ESV Implementation Plan that addresses federal legislation for land use.
4	Are all the DOE sites creating RBES documents?	No. Only DOE sites with a current Environmental Management (EM) cleanup mission (38 sites) are required to prepare an ESV, but 10 of these are not required to submit a final End State Vision for various reasons.
5	The RBES should consider risk perceptions by the public.	SRS is preparing a "civic club-type" presentation to communicate risk concepts and methods. This will also address real risk and perceived risk.

#	Comments: on the March 2004 Risk-Based End State Vision	Status/Response:
6	Variances in the RBES need more understanding, e.g., Are alternatives to disposing of salt included?	See Appendix B, <i>Alternative End States and Recommendations</i> . An Alternative End State is defined as significantly different cleanup approach or different end state relative to the SRS EM Performance Management Plan. Alternatives for disposing of salt are not included.
7	How do you deal with alternative uses of SRS? New missions? How are these put into the document?	See Chapter 1 for a list of potential new missions. Additional discussion on the new missions can be found in the <i>SRS Ten Year Site Plan</i> .
8	Does the RBES consider the ecology impact during remediation? This needs to go into the policy portion of the document.	For inactive waste unit cleanup, ecology impacts are evaluated under the Resource Conservation and Recovery Act (RCRA) and/or the Comprehensive Environmental Response, Compensation and Liability Act (CERCLA) in the Remedial Alternative (RA) selection process. The risk that contaminants pose to ecological receptors before remediation is also part of the baseline risk assessment process.
9	Will the Deactivation and Decommissioning (D&D) of the Mixed Oxide Fuel Fabrication Facility (MFFF) and the Pit Disassembly and Conversion Facility (PDCF) be covered in Environmental Management (EM)?	Current DOE policy is that future DOE programs will address their respective waste management and D&D. Since both of these facilities will be built and operated under the National Nuclear Security Administration (NNSA), NNSA will be responsible for the D&D of these facilities.
10	For the Spent Nuclear Fuel (SNF) disposition, will SNF go to the federal repository and will it be gone from SRS by 2025?	Yes. See Table 4.1 and Section 4.2.3, Spent Nuclear Fuel. The End State Vision is that SNF will be gone from SRS by 2020.
11	How do you identify facilities needed for future missions? Is there a DOE-wide review? Can a contingency list be set up for these?	There is a federal and DOE asset management process to make all excess assets (including facilities) available for reuse before D&D is approved.
13	How will the site take care of nuclear material in the nooks and crannies in the facilities?	Deactivation procedures address the appropriate level of cleanup before final Decommissioning.
14	Has the site put any SNF in dry casks for shipment yet? Will this be done for just-in-time shipments?	The site is not currently packaging spent nuclear fuel for shipment to the repository. When packaging does start, rate will support site closure, well ahead of repository shipment.

#	Comments: on the March 2004 Risk-Based End State Vision	Status/Response:
15	Will 235-F be available for storage of material from Hanford? Suggestion - Change K-Area and 235-F to "interim" storage facilities.	All plutonium will be removed from SRS by 2025, reference Table 4.1 and Section 4.2.1. The PMP addresses how the end state for the plutonium hazard will be attained.
16	Does the site have approval to send material to Yucca Mountain, e.g., spent fuel, aluminum clad fuel? What is the schedule for acceptance? What are the options for moving Plutonium (Pu) offsite?	Yucca Mountain is assumed to be licensed, constructed and available for SRS receipts of DWPF canisters by 2010. SNF is also assumed to be shipped to Yucca Mountain. Plutonium will be removed from SRS via Mixed Oxide (MOX) fuel fabrication, processed through the HB-Line facility or to a federal repository.
17	Referencing Bruce Schappell's presentation - Does the alternative analysis include effects on ecology?	For inactive waste unit cleanup, ecology impacts are evaluated under RCRA/CERCLA in the Remedial Alternative (RA) selection process. For example, CMS/FS (Corrective Measures Studies / Feasibilities Study). See Section 1.3, Hazard and Risk Relationship and Appendix G, Land Use, Risk and Cleanup Decision Process.
18	For the risk evaluation scenario's, the trespasser and future resident are not included in the RBES strategy. They should not be included in the evaluations either.	Residential use is not anticipated in either planned or alternative end state for SRS. The Trespasser scenario is for unintended exposure, but potential for some site areas (e.g. near site streams and/or boundaries that have potential offsite access) where industrial development is not feasible. It is typically a much smaller amount of exposure than industrial.
19	How do you show the RBES process has an impact on regulator acceptance? Has it made a difference?	ESV initiates dialog on planned and alternative end states. Final decisions are to be determined. Historically, SRS regulators have been receptive to sustainable and protective alternatives that comply with the law.
20	When looking at assessments, etc., do you consider the baseline of the National Environmental Research Park (NERP) and is the Savannah River Ecology Lab (SREL) part of the process?	SREL data and resources are used in cleanup assessments and remediation. SRS has an established environmental "baseline" largely due to the SREL initiatives, and the effects of SRS activities are protective of the environment through numerous regulatory requirements and DOE policies. SREL has extensively studied the effects of SRS nuclear and industrial activities on baseline environmental conditions for over 50 years. This well characterized

#	Comments: on the March 2004 Risk-Based End State Vision	Status/Response:
		and protected environmental baseline is the value of the NERP designation by DOE.
21	Can the site delete the 'resident' scenario for consideration? It is misleading to the public. In the RBES the site should explain how we use this scenario and why.	The site does not plan to delete the “resident” scenario in the cleanup assessment process. It is required. Additional explanation is provided on the resident scenario in Appendix G, <i>Land Use, Risk and Cleanup Decision Process</i> , in the ESV.
22	What is the status of the plug-in Record of Decision (ROD)? What can be done to speed up the process and/or reduce the paperwork?	The FFA three parties continue to negotiate appropriate application of the plug-in ROD approach. An initial plug-in approach was successfully implemented for all reactor seepage basins at SRS. An area completion approach is being developed in which all remaining hazards and releases in an SRS area are assessed and remediated through a single project.
23	What is the status and plans for the use of mixing zones?	Several mixing zones are in effect through signed RODs at SRS and future groundwater remedial decisions will consider mixing zones and/or Monitored Natural Attenuation. See ESV Chap 4, Section 4.2.12, for a discussion for SRS Groundwater cleanup strategy.
24	What is the process for de-listing from the National Priority List (NPL)?	After remediation goals are achieved, DOE will petition the EPA for deletion of the appropriate portion of the SRS from the NPL. See EPA reference for additional deletion info.
25	What is the time frame for remediation of the 69 "high" risk sites?	All will be complete and in long term stewardship (if needed) by 2025.
26	How do you address non-carcinogenic risks, e.g., VOC, etc.?	Hazard Indices (HI) for non-carcinogens are addressed for all inactive waste unit assessments. Additional risk evaluation description has been incorporated in the ESV hazard and risk section 1.3. All SRS soil remediations are currently and projected to accommodate the Comprehensive Environmental Response, Compensation and Liability Act (CERCLA) cancer risk assessment levels of either less than one in a million (< 10 ⁻⁶) for a residential (unrestricted) scenario or between a one in ten thousand to one in a

#	Comments: on the March 2004 Risk-Based End State Vision	Status/Response:
		million (10-4 to 10-6) industrial worker scenario with institutional controls. A corollary approach is implemented for non-cancer risk (presented in terms of hazard indexes) but is not presented to simplify SRS's end state concept.
27	On Page 5 of the Soil and Groundwater presentation, what does "inaccessible" mean?	Waste units that are currently not accessible due to continuing operations in industrial areas.
28	Is there any agreement from NNSA to pick up ownership of site facilities?	NNSA currently owns the Defense Program tritium facilities and will own the planned Nuclear Nonproliferation MOX, Pit Disassembly and Conversion Facility and the Waste Storage Facility. There is no agreement for NNSA to assume responsibility for other SRS facilities at this time.
29	Will SRS submit more information to the State Historic Preservation Office (SHPO)?	Not part of ESV initiative; however, a Programmatic Agreement with the Advisory Council on Historic Preservation and State Historic Preservation Officer and Memoranda of Agreements were signed in 2004.
30	What is the schedule for information to go to SHPO on the D&D'ed buildings of historical significance? Is the material that goes to SHPO available to the public?	See the Department of Energy Savannah River Operations Office, <i>Savannah River Site's Cold War Built Cultural Resources Management Plan</i> , January 25, 2005.
31	What is the process for handling artifacts?	For pre-SRS artifacts, the University of South Carolina Institute of Archaeology and Anthropology handles artifacts. For SRS artifacts, DOE is working with several groups, described in Department of Energy Savannah River Operations Office, <i>Savannah River Site's Cold War Built Cultural Resources Management Plan</i> , January 25, 2005.
32	Is there a role at SRS for the Office of Legacy Management (LM)?	No. Currently, LM is responsible for Closure sites only. SRS is not a closure site.
33	How do we get facilities for potential future missions on the list for consideration to be saved from D&D?	There is a federal and DOE asset management process to make all excess assets (including facilities) available for reuse before D&D is approved.

#	Comments: on the March 2004 Risk-Based End State Vision	Status/Response:
34	What happens when NNSA, etc., takes ownership of a facility, is it immediate?	Usually there is a memo documenting the transfer of assets from one DOE programmatic office to another. There is not an official process. The DOE FIMS (Facility Information Management System) is the official DOE asset management database and the DOE program owner is established in this database.
35	There needs to be an early evaluation (cost and alternatives) of facilities scheduled for in situ end state to verify that in situ makes sense.	Please see Savannah River Site, <i>SRS Environmental Management Integrated Deactivation and Decommissioning Plan</i> , May 2003 "super model" which addresses the initial preliminary evaluation process. Also see ESV Appendix B, <i>Alternative End States and Recommendations</i> .
36	DOE should consider NRC's work on how to decommission facilities.	NRC's decommissioning process is being considered by the D&D program.
37	In relation to the Composite Analysis and in order to make risk informed decisions, what is the inventory in the LRW tanks? Canyons? The 100 Area?	See information in Table 4.1. The residual source terms in each of these facilities after their decommissioning will be determined when their decommissioning is planned and executed and accounted for in the final area closure (soil and groundwater cleanup) activities. Composite analysis may help to determine acceptable residual source terms, along with other exposure/risk factors.
38	What is the alternative path to the WIR lawsuit?	The FY 2005 National Defense Authorization Act, Section 3116, has provided clear direction for SRS LRW waste disposition. No alternative plan is needed.
39	What is the volume of LRW generated annually?	The volume of LRW generated annually varies with the H and F Area Canyon activities. Special efforts have been implemented to reduce the amount of LRW generated. The current rate is about 550,000 gallons annually after evaporation.
40	Is the site still reevaluating non-compliant items for WIPP?	No, for drum waste and yes, for large container waste. SRS will ship the majority of its drum waste to WIPP by the end of 2006 without the need for relief on non-compliant items. SRS will need to look for relief with non-compliant items in its large container waste after it

#	Comments: on the March 2004 Risk-Based End State Vision	Status/Response:
		can x-ray a large sample of the waste in late FY2006.
41	At one time there was talk about the definition of TRU waste being revised, is that still being considered?	No, DOE is not considering redefining TRU waste.
42	What was the role of the regulators in the creation of the RBES document?	Regulators were consulted and briefed on the initial RBES guidance and process on multiple occasions. They are aware of the <i>SRS End State Vision</i> , but declined to comment on previous versions, since binding decisions are made on specific issues through regulatory processes. Future land use alternatives were reviewed and discussed with them.
43	<p>I think the concept of development of a Risk Based End State vision document for SRS is a worthwhile effort and can be useful in reaching consensus within DOE and with the public. I like the integration with the PMP. I agree with the proposed end states, for the most part, but find the document falls short of its defined objective.</p> <p>As I understand the objective of this initiative, it is to provide information defining the proposed end states and sufficient information that supports why the proposed end states are the proper end state. That latter information is missing from the RBES document. I will site two end state visions that are probably reasonable but no information is provided to substantiate the proposed end states.</p> <p>The two examples of too little information to reach agreement on the end vision are discussed below:</p>	<p>Since there is still significant work needed to arrive at what will be the acceptable amounts of residuals left in tanks and facilities, based on performance assessment work in the future, some of the information does not exist today. The ESV describes the strategy and expected end state goals. (See Table 4.1.)</p> <p>Additional text was added to Section 4.2.5 to address this comment.</p>

#	Comments: on the March 2004 Risk-Based End State Vision	Status/Response:
	<p><u>First Example: Liquid radioactive waste Disposition.</u> At the RBES Open House Mr. Joe Carter described the LRW disposition proposed to reach the planned end states of offsite disposal and onsite disposal of closed and stabilization of 51 underground LRW tanks (F- & H-Areas) and saltstone in 2 vaults in Z-Area. Mr. Carter's presentation was focused on how the waste processing (sludge and supernate) end visions could be met and not on LRW tank closure and those end state.</p>	<p>The sampling, analysis and determination activities will be ongoing for the next ten years or more. The strategy supports a performance based approach to LRW disposition and tank closure that will meet air, water and radiation safety regulations.</p> <p>Please see information that has been added to section 4.2.5, Liquid radioactive waste. Additional text was added to Section 4.2.5 to address this comment</p>
	<p>As I read the RBES vision document, I note that F-Area has 22 of the LRW tanks (Table 4.12a of the RBES) and H-Area has the remaining LRW tanks (Table 4.13a). The descriptive information from Chapter 4 page 19 states that all 22 LRW tanks in F-Area will be "closed (removed from service and filled with grout)". The text on page 22 states that LRW tanks in H-Area will be deactivated before in-situ disposal and the text goes on to say that emptied tanks will be removed from service and filled with grout. Page 32 of Chapter 4 gives the end state vision of the DWPF and SWPF as deactivation by isolating and filling with grout. It goes on to discuss closure of the Failed Equipment Storage Vaults and the GWSB. Z-Area end state vision is to close the grout plant and install a perimeter fence. There is no mention of the end vision of the saltstone vaults and how they will be stabilized.</p>	<p>Please see information that has been added to section 4.2.5, Liquid radioactive waste. Additional text was added to Section 4.2.5 to address this comment</p>

#	Comments: on the March 2004 Risk-Based End State Vision	Status/Response:
	<p>The description of this end vision contains no discussion of the amounts of radionuclides and hazardous waste that will be left in the LRW tanks, closed process facilities, and saltstone vaults. Acceptance of this end vision depends upon the residual inventories left at SRS, the cost of further cleanup, and the hazards of further cleanup and the final residual hazards. None of these have been discussed in this LRW system section of the RBES. Mr. Carter discussed some of these at the open house. Just about all we know from the draft RBES is how many facilities will be demolished and how many will be in-situ disposal.</p>	<p>Please see information that has been added to section 4.2.5, Liquid radioactive waste. All residual inventories will be demonstrated to be protective of human health and the environment through the processes required by law and/or DOE Orders. <i>DOE Environmental Impact Statements on Salt Processing Alternatives</i> (DOE/EIS-0082-S2D; July 2001) and <i>High Level Waste Tank Closure</i> (DOE/EIS-0303; May 2002) discuss quantities that may remain after closure of these facilities. Additional text was added to Section 4.2.5 to address this comment</p>
	<p><u>Second Example: End States for Major Production Facilities at SRS.</u> The end states for the five reactor buildings (C, P, R, L, & K) use slightly different words but basically state that all hardened reactor buildings will be deactivated. The production buildings in F-, H- Areas are said to be decommissioned and placed in in-situ disposal. S-Area facilities are stated to be deactivated by isolating utilities and filling the canyon cells with grout. At the open house a DOE representative stated that F-Canyon and B-Line equipment would probably be removed before placing the building in in-situ disposal. These differences may not be significant but point out that SRS has not considered the real meaning of in-situ disposal.</p>	<p>See response above. The details of the in-situ disposal end state for these facilities have not been determined yet. The hazard that will remain after each facility is decommissioned will be manageable through the area cleanup remedy. DOE believes that complete demolition is not warranted or necessary for long-term protectiveness.</p>

#	Comments: on the March 2004 Risk-Based End State Vision	Status/Response:
	<p>There is no information given on why these general end visions were made. No risk information is provided to show that the public and workers on the SRS site in the future will be safe. What level of decontamination of these facilities is acceptable? This information needs to be available before SRS will get a stakeholder consensus on in-situ disposal.</p> <p>I hope the two examples assist SRS in upgrading the RBES before its issue so that the SRS end visions are understood and leads to discussion and commitments that lead to consensus on this important view of the end visions for the various portions of SRS. As I see it this document should focus on the end visions and the PMP should contain the commitment milestone needed to reach these visions.</p>	<p>Since the end state conditions of the facilities are not known in detail, and the type and frequency of exposure to the residual hazards is based on a future use assumption that may change, future risk information is difficult to produce.</p> <p>Facility and hazard end states will be demonstrably protective in order to meet, requirements of the Comprehensive Environmental Response, Compensation and Liability Act (CERCLA), state and federal regulatory permits, and DOE.</p>
44	<p>I would like to turn my discussion to the vision of land use at SRS. A major premise of the SRS RBES vision is that the lands of SRS will be owned by the federal government in perpetuity (page 3 of the Executive Summary) and used for industrial purposes for future DOE and non-DOE missions. This condition (federal ownership in perpetually) is a DOE controlled condition and not established by any law. Page 4 of the ES states that SRS has recommended Congressional Authorization. No further information is provided on this Congressional Authorization.</p> <p>I am not comfortable with this assumption of federal ownership in perpetuity so long as it is only a DOE decision that could be overturned by a future Secretary of Energy or other high-level DOE employee. It needs to be institutionalized by congressional action. Also, all governmental agencies are not equal in this area. The governmental agency should be knowledgeable in management of lands that are contaminated with nuclear and hazardous chemical wastes.</p>	<p>See Section 2.9 of the Executive Summary. DOE agrees with you and recommends formal Congressional Authorization to provide perpetual federal ownership and responsibility for SRS within its current fixed boundaries.</p>

#	Comments: on the March 2004 Risk-Based End State Vision	Status/Response:
	<p>This important premise undergirds many of the vision end states. This is used in much (but not all of the RBES document) and prevents consideration of turning the lands over to public occupation and use (no private homes, subdivisions, private utilities, etc. are allowed). This end vision should be used consistently throughout the document. I noted groundwater and soils end visions do not use the same vision. They assume cleanup of lands and groundwater to allow residential scenarios.</p>	<p>Land (soil) cleanup is not designed to achieve residential levels. Industrial cleanup levels are generally used.</p> <p>Current regulations and state policies require that groundwater be remediated to achieve drinking water standards over time.</p>
45	<p>Now again I will turn my comments to the variances discussed in Appendix E. I will take one variance and discuss it. It is an alternative disposal for Pu-238 contaminated solid waste (see Appendix E, page 7). If this TRU waste were to be stored in a saltstone or other concrete vault, the Pu-238 that is currently called TRU waste would rapidly decay so that the waste would no longer be TRU waste but LLW long before the concrete storage container would be breached. This alternative should be given wide consideration. The details of this alternative, its safety, the environmental regulatory requirement changes, cost savings, etc. should be discussed and if warranted proposed end vision modified to those associated with this variances. The PMP should include milestones for consideration of the benefits of the variance and approaches for their adoption.</p>	<p>DOE has made no policy change in disposing of TRU waste. Until DOE makes a policy change, all SRS TRU waste will go to WIPP. In the future, if DOE finds it will be difficult to ship some of its TRU waste to WIPP due to technical or worker risk issues, then it will consider alternatives to WIPP disposal. At that time, DOE will prepare details of alternatives. (See Alternative 2 in Appendix B, <i>Alternative End States and Recommendations</i>.)</p>
46	<p>All five variances in Appendix E are given very little attention in this report. It is my understanding that the RBES guidance required discussion of changes needed for alternate end states. These alternatives need to be given more attention and should be included in the body of the report (not in an Appendix). Again the RBES should describe the variances (alternatives) and the PMP should define a process for their consideration with milestone steps needed for their acceptance.</p>	<p>See Appendix B, <i>Alternative End States and Recommendations</i>. Each of the alternative end states described there has value to accelerating or increasing risk reduction at SRS. The appropriate timing for pursuing each of them is discussed in Appendix B.</p>

#	Comments: on the March 2004 Risk-Based End State Vision	Status/Response:
47	<p>Overall, the RBES is a well developed and produced report reflecting Savannah River Site's impact and imprint on the region. DOE-SR and their contract partners should be commended for developing processes and goals to ensure that the legacy of SRS will be a responsible one. However, our office remains concerned that preservation and interpretation of historic properties owned by DOE-SR has not been fully integrated into site planning reports such as the RBES, or into the legacy of the important missions that occurred at SRS. We encourage DOE-SR to more fully integrate into SRS site planning and end state reports such as the RBES applicable historic preservation mandates such as Section 106 and 110 of the National Historic Preservation Act and Executive Order 13287. The intent of these mandates requires such planning and mission related integration to be undertaken by federal agencies.</p>	<p>Since the March 2004 draft was written several Memoranda of Agreements have been signed, including the following:</p> <ul style="list-style-type: none"> ♦ <i>Programmatic Agreement (PA) Among the U. S. Department of Energy (DOE), the South Carolina State Historic Preservation Office (SHPO), and the Advisory Council on Historic Preservation for the Management of Cold War Historic Properties on the Savannah River Site (SRS), Aiken, Barnwell, and Allendale Counties</i> (the ACHP includes the SRS Citizens Advisory Board, the Citizens for Nuclear Technology Awareness, City of Augusta, City of Aiken, and the City of New Ellenton. ♦ <i>Memorandum of Agreement Between the U. S. Department of Energy – Savannah River Operations Office (DOE-SR) and the South Carolina State Historic Preservation Office (SHPO) Pursuant to 36CFE Part 800.6 for the Mitigation of Certain Adverse Effects to D-, M-, and T-Areas, Savannah River Site (SRS), Aiken and Barnwell Counties, South Carolina</i> <p>In addition, DOE-SR published the <i>Savannah River Site's Cold War Built Environment Cultural Resources Management Plan (CRMP)</i> in February 2005.</p> <p>These MOAs and the CRMP address these concerns.</p>

#	Comments: on the March 2004 Risk-Based End State Vision	Status/Response:
	<p>While the RBES may not have historic preservation concerns as its goal, we believe that the RBES should better incorporate these concerns into the environmental cleanup mission (for example, the condition of buildings and potential for re-use). The RBES should also discuss how historic preservation and cultural resources management (CRM) goals will be integrated into SRS's end state vision and how DOE-SR site management will implement it. For example, the RBES details how selected facilities will be decommissioned through in situ disposal (due to the fact of demolition being very expensive and unnecessary) but does not discuss in situ disposal as a means towards preservation of such facilities, or how such facilities own end state vision should include proper maintenance, preservation and interpretation. Consequently, preservation should also be included within the scope and recommendations made within the section "Alternate End State - In Situ Decommissioning in lieu of Demolition."</p>	<p>See response above</p>
	<p>In reference to, "The SRS EM PMP is being currently revised to reflect significant changes since issuance of the first PMP in August 2002," we believe the list of significant changes should include the Savannah River Site's Cold War Built Environmental Cultural Resource Management Plan (CRMP), in addition to current Programmatic Agreement (PA) consultations between DOE-SR, SHPO, and other signatory and concurring parties. The CRMP and the PA, once agreed to and implemented, will certainly affect how DOE-SR will manage the SRS.</p>	<p>The CRMP is mentioned frequently in the latest version of the ESV and included in the <i>Appendix F, References</i>.</p>
	<p>In reference to the section "Cultural Resource Management," discussed under "Other EM Programs," we recommend expansion of this section to include why DOE-SR undertook the related CRM actions (compliance with the NHPA), agreements and mitigation that have resulted from this compliance, and further discussion of the</p>	<p>The CRMP addresses these concerns and is referenced in the ESV.</p>

#	Comments: on the March 2004 Risk-Based End State Vision	Status/Response:
	<p>way stewardship of historic properties will be integrated with ongoing site missions. This discussion should include the preservation of historic properties and associated artifacts, public education and interpretation as tools of CRM that DOE-SR will use to describe the Cold War contribution that SRS made to our nation's history. Lastly, this section, unlike the rest of the RBES, contains many technical errors. Thus, this section needs to be corrected and revised carefully.</p>	
	<p>We also recommend the RBES Appendices include applicable tables from the CRMP or the SRS Cold War Context and Resource Study such as the SRS Cold War Historic District and Cold War Resources Inventory Tables.</p> <p>Thank you for consideration of our comments on the draft RBES. If you have any questions concerning these comments, please contact John Sylvest at 803-896-6129.</p>	<p>The CRMP includes the information that the reviewer requested to be included. To avoid duplication, this information is not provided in the ESV, but the ESV references the CRMP.</p>
48	<p>Page 11, Acronyms: USFS - United States Forestry Service at Savannah River Site. Change to USFS-SR - USDA United States Forest Service - Savannah River</p>	<p>Change made.</p>
49	<p>I appreciate the opportunity to review the draft Risk-Based End State (RBES) Vision document dated March 30, 2004. Even though the Savannah River Site is not a 'closure site' and has long-term continuing missions, I concur it is important for the Department of Energy and the communities surrounding SRS to be in agreement regarding the end state of facilities and lands under Environmental Management stewardship as DOE/EM programs and projects are completed. The draft RBES vision document is a good basis for discussions to achieve agreement in this important matter.</p> <p>On behalf of this organization, I offer the following comments and recommendations as you revise the RBES Vision document and submit it to DOE Washington for approval.</p>	<p>No response needed.</p>

#	Comments: on the March 2004 Risk-Based End State Vision	Status/Response:
	<p>1. We strongly concur that the present SRS boundaries remain intact and that SRS lands remain under federal jurisdiction in perpetuity.</p> <p>a. We support the assumption that SRS lands not be used for residential type applications. We recommend that end state standards be established consistent with industrial uses, not more restrictive and costly residential uses.</p> <p>b. We support the concept that SRS boundaries be established in legislation. SRS is a national asset, and protections should be established which preclude its dismemberment by administrative action.</p> <p>c. SRS's designation as a National Environmental Research Park should be included in future legislation. Maintaining the long-term environmental baseline is important for ongoing and future studies of the interaction between industrial activities and the environment.</p>	<p>DOE-SR appreciates your support and concurrence in these initiatives.</p>
50	<p>2. We recommend that disposition of excess facilities be coordinated with state and local community organizations and that <u>a moratorium immediately be placed on demolition of SRS facilities.</u></p> <p>a. Many current and future excess SRS facilities have potential uses for off-site economic development activity. This is especially true for general purpose facilities located near the SRS boundary.</p> <p>b. We note that SRS is proposing to demolish facilities that have been identified as site assets for the pending Modern Pit Facility. Demolition of these facilities (1) reduces SRS's advantage in competing for this important new mission and (2) causes an increase in MPF project costs.</p> <p>c. We note that you have not yet responded to the March 30, 2004 letter from Dr. Tom Hallman, Chairman, Savannah River Site Redevelopment Authority concerning the availability of specific buildings.</p>	<p>Since the March 2004 draft was written several Memoranda of Agreements have been signed, including the following:</p> <ul style="list-style-type: none"> ♦ <i>Programmatic Agreement (PA) Among the U. S. Department of Energy (DOE), the South Carolina State Historic Preservation Office (SHPO), and the Advisory Council on Historic Preservation for the Management of Cold War Historic Properties on the Savannah River Site (SRS), Aiken, Barnwell, and Allendale Counties</i> (the ACHP includes the SRS Citizens Advisory Board, the Citizens for Nuclear Technology Awareness, City of Augusta, City of Aiken, and the City of New Ellenton. <p>In addition, before facilities are demolished, economic development groups are contacted to determine if the facility could be used for economic development.</p>

#	Comments: on the March 2004 Risk-Based End State Vision	Status/Response:
51	<p>3. We recommend the document identify the specific disposal pathways for plutonium which will not be used in the MOX process and for research reactor fuel received and stored at SRS.</p> <p>a. Without a disposal pathway, there is little confidence that the proposed end state is valid. Facilities and processes must be developed to achieve final disposition for these materials, and these new facilities/processes can influence the end state.</p> <p>b. Long-term storage of excess plutonium on SRS is not an acceptable end state. The communities and public surrounding SRS expect that materials with no future use be placed in ultimate disposition, not remain in storage at SRS.</p> <p>c. Recent discussion of consolidating excess plutonium from other DOE sites to SRS further underscores the importance of this concern.</p>	<p>Options for disposition of these materials exist to meet the proposed end states. However, these options are still under development and are pre-decisional. Therefore, they are not available for discussion now, but they will be discussed in a forum specific to this issue, to support decision making. They will also be included in future revisions of this document. The intent is to disposition these materials by 2019 to enable SRS to meet the 2025 end state for the material storage facilities.</p>
52	<p>4. The proposed 'variance' for alternate disposal of plutonium 238 contaminated wastes is not well described and a potential source of concern. Pending resolution of our questions, we recommend against adoption of this variance.</p> <p>a. As we understand the variance, it is proposed that certain Pu-238 contaminated wastes remain, in perpetuity, at SRS because of anticipated difficulties and hazards associated with retrieval, sorting and transportation. The RBES draft does not identify the quantities of materials (volume and curies content) proposed for final disposition at SRS.</p> <p>b. SRS has not conducted a performance assessment and risk assessment for materials to be disposed at SRS. Given the long half-life of Pu-238 and its highly mobile nature, we believe that these materials cannot be contained on SRS, will be released into the environment and will reach the offsite public.</p> <p>c. Significant scientific and engineering studies concluded that disposal of TRU wastes in salt deposits (WIPP) was the preferred</p>	<p>DOE has made no policy change in disposing of TRU waste. The planned end state is that all SRS TRU waste will go to WIPP. In the future, if DOE finds it problematic to ship some of its TRU waste to WIPP due to technical or worker risk issues, then it will consider alternatives to WIPP disposal. At that time, DOE will prepare details of alternatives. Any alternatives evaluated would include a performance assessment as well as risk assessment.</p> <p>Appendix B, <i>Alternative End States, and Recommendations</i>, has been rewritten to explain the evaluation of an alternative end state for Pu-238-contaminated waste.</p>

#	Comments: on the March 2004 Risk-Based End State Vision	Status/Response:
	disposal option. Why would SRS want to take a contrary position?	
53	<p>The SRS CAB's Long Term Stewardship Subcommittee (2000 -) identified one of the priorities to be addresses by the SRS as: develop and provide a mechanism for public participation to educate the public on (the then term) long term stewardship. That effort was set aside when DOE-HQ guidance and organization on LTS changed. The RBES Vision document can and should be a catalyst to begin raising the public's awareness about the transition occurring within the Savannah River Site. SRS is not a closure site but is undergoing various forms of transition: from EM units to NNSA; from inactive to D&D; and eventually from decommissioning to Legacy Management (or the old Long Term Stewardship). Each of these types of transition may entail flexible forms of and appropriate public participation processes. They need to be defined. For instance, the SRS Citizens Advisory Board structure may not be the most effective structure for public input as these three types of transition occur.</p>	<p><i>See Appendix E, Long Term Stewardship; DOE Policy 454.1, Use of Institutional Controls and DOE Policy 141.2, Public Participation and Community Relations</i></p>

#	Comments: on the March 2004 Risk-Based End State Vision	Status/Response:
	<p>The site needs to begin a dialogue as to what processes will be most effective as these changes occur.</p> <p>The RBES Vision document can be used to conceptualize then organize the appropriate public participation processes for these transitions (or the initial group which can develop the processes).</p> <p>The site can begin by using the RBES Appendix F regional planning organizations as core team members (at minimum) to begin developing the public participation process and schedule of implementation. This initiative would be separate from the SRS CAB recommendation on educating the public on the nature of "risk" as used in the RBES document.</p> <p>Finally, the issue of long term stewardship or public participation as the site transitions to legacy management should be addressed in the main body of the report, not just in the Appendix (App H). <u>This should be included as one of the needs addressed by the RBES document (Chapter 1).</u></p>	<p>See response above.</p> <p>Long-term stewardship or public participation as the site transitions to legacy management will be addressed in the next iteration of the SRS ESV.</p>
	<p>Note: at the end of the RBES workshop, I asked, "What is the process for determining the end-state of the (SRS) CAB? (There were a few chuckles...) The question <u>is</u> related to the heart of the use of the RBES Vision document and the (end) vision of <u>future uses of public input.</u></p>	<p>See response above.</p>
54	<p>Chapter 1: p. 7, Table 1.2 Gold Metrics: It would be helpful to the layman to <u>see a percent (of completions) column</u> between "To Go" and "Life-Cycle Scope".</p>	<p>Table 1.2 will be changed to reflect %.</p>
55	<p><u>Ex Summary</u>, Barriers to..., third bullet: "s "poisoning" the correct word?"</p>	<p>Poisoning is correct.</p>
	<p>The following nine comments are the SRS Citizens Advisory Board (CAB) Recommendation 190 on the Risk-Based End State Vision. The responses are the ones provided to the SRS CAB at that time.</p>	

#	Comments: on the March 2004 Risk-Based End State Vision	Status/Response:
	<p>1. SRS provide additional information about the risks, both human health and environment, associated with the end states proposed.</p>	<p>The revised <i>SRS End State Vision</i> will include additional information on the human health and environmental risks associated with the Site’s currently planned end states and potential alternative end states for each of the hazard types at SRS, including EM facilities to be decommissioned and plutonium-238 contaminated wastes. Risk balancing (that is the risk reductions achieved by an action, as compared to the risk involved in taking the action or other trade-offs) will be considered and discussed as well. As we progress with the cleanup of hazards by area at SRS, more information about these hazards will be obtained, and more detailed risk assessments will be developed where appropriate. Progress and ideas will be discussed with the SRS CAB through periodic Board and committee meetings. The difference between perceived risk and actual risk are discussed in the SRS ESV in Appendix G, Land Use, <i>Risk and Cleanup Decision Process</i>, and will be topic of the presentation on risk that DOE will develop for the public.</p>
	<p>2. SRS clearly articulate the plan and approach for reaching public acceptance of the end state visions.</p>	<p>The SRS ESV, as an examination of planned end states and possible alternatives to be achieved by the SRS cleanup program, will be an ongoing process that will involve SRS regulators and the public. New cleanup alternatives may arise in the future that will make it possible to realize protective and sustainable end states that have not been proposed or evaluated before.</p> <p>The first phase of that process has been public and regulator input to the draft SRS RBES Vision Document. That input occurred in meetings with regulators, in the public workshop hosed by the CAB, and during a public comment period that ended in May. DOE’s plan to promote public acceptance of the final ESV is to continue to work with our regulators and to inform the public as we determine appropriate end states. Within the regulatory framework, end states involve decisions that require negotiation with our regulators and public notification and involvement. We will also continue to inform</p>

#	Comments: on the March 2004 Risk-Based End State Vision	Status/Response:
		the public through the SRS CAB and other public forums such as Environmental Justice meetings. In addition, DOE has determined that additional public participation is appropriate before finalizing the document in December of this year. A workshop will be conducted on October 5-6, 2004, to discuss the next steps in the risk-based end state process. The workshop will be conducted with assistance from the National Governor’s Association and details of the workshop will be provided when a location and agenda are determined.
	SRS develop a RBES outreach effort to educate the general public on the difference between perceived risks to human health and the environment and actual risks associated with SRS end states.	See response to CAB Recommendation 1.
3.	Regarding future land use, DOE-SR and DOE-HQ pursue Congressional Authorization to provide perpetual federal ownership and responsibility for SRS’s fixed boundaries.	DOE is considering additional surety of future land use by pursuing Congressional authorization creating perpetual Federal ownership and responsibility for SRS. This initiative is in the early stages of planning. The SRS ESV includes a discussion of the integration of historic preservation, cultural resources management, and the Site’s National Environmental Research Park status. Also the SRS ESV will be factored into updates to the <i>SRS Comprehensive Plan</i> including the <i>SRS Future Use Plan</i> .
	SRS include a discussion on how historic preservation, cultural resource management (CRM) goals, and continued National Environmental Research Park (NERP) designation are integrated into the SRS end state vision and how SRS will implement them.	See response to CAB Recommendation 4.
	SRS evaluate alternative disposal options for Pu-238 contaminated waste so that the risks associated with handling and shipments are protective of human health and the environment.	See response to CAB Recommendation 1.
	SRS continue to develop “area” risk assessment methodology and protocols protective of human health and the environment.	DOE is working collaboratively with our regulators and stakeholders to develop an effective and efficient methodology for assessing risks on an area scale. This initiative advances accelerated cleanup decision-making and remediation at SRS.

#	Comments: on the March 2004 Risk-Based End State Vision	Status/Response:
	SRS determine and evaluate the risks of in situ decommissioning in lieu of demolition.	See response to CAB Recommendation 1.
	DOE-HQ request and work with the Nuclear Regulatory Commission to revise the LRW federal repository glass durability specifications to allow an increase in waste activity loading above the current specifications.	DOE will continue to collaborate with the Nuclear Regulatory Commission, National Academies, and other associated parties to effect a change to the Federal Repository’s specifications for LRW glass durability that would enable SRS to increase waste activity loading at the Defense Waste Processing Facility.

THIS PAGE INTENTIONALLY LEFT BLANK

APPENDIX I
Watershed Conceptual Site Models, and Hazard Tables

	Figures
Figure 4.0	SRS Sitewide Conceptual Site Model
Figure 4.1b	Upper Three Runs Watershed/IOU G-Area CSM
Figure 4.2b	Fourmile Branch Watershed G Area IOU
Figure 4.3b	Pen Branch Watershed G Area CSM
Figure 4.4b	Steel Creek Watershed/IOU G Area CSM
Figure 4.5b	Lower Three Runs Watershed G Area CSM
Figure 4.6b	Savannah River Watershed G Area CSM
	Tables
Table 4.1 a	ESV Planned End State By Watersheds (G-Area Only)
Table 4.1 b	EM Integrated Deactivation and Decommissioning Plan (G Area Only)
Table 4.2	ESV Hazard Type Crosswalk for Watershed "To Go" Units (G-Area Only)

WATERSHEDS

The discussion on watersheds can be found in Chapter 4, Hazard Specific Discussion.

THIS PAGE INTENTIONALLY BLANK

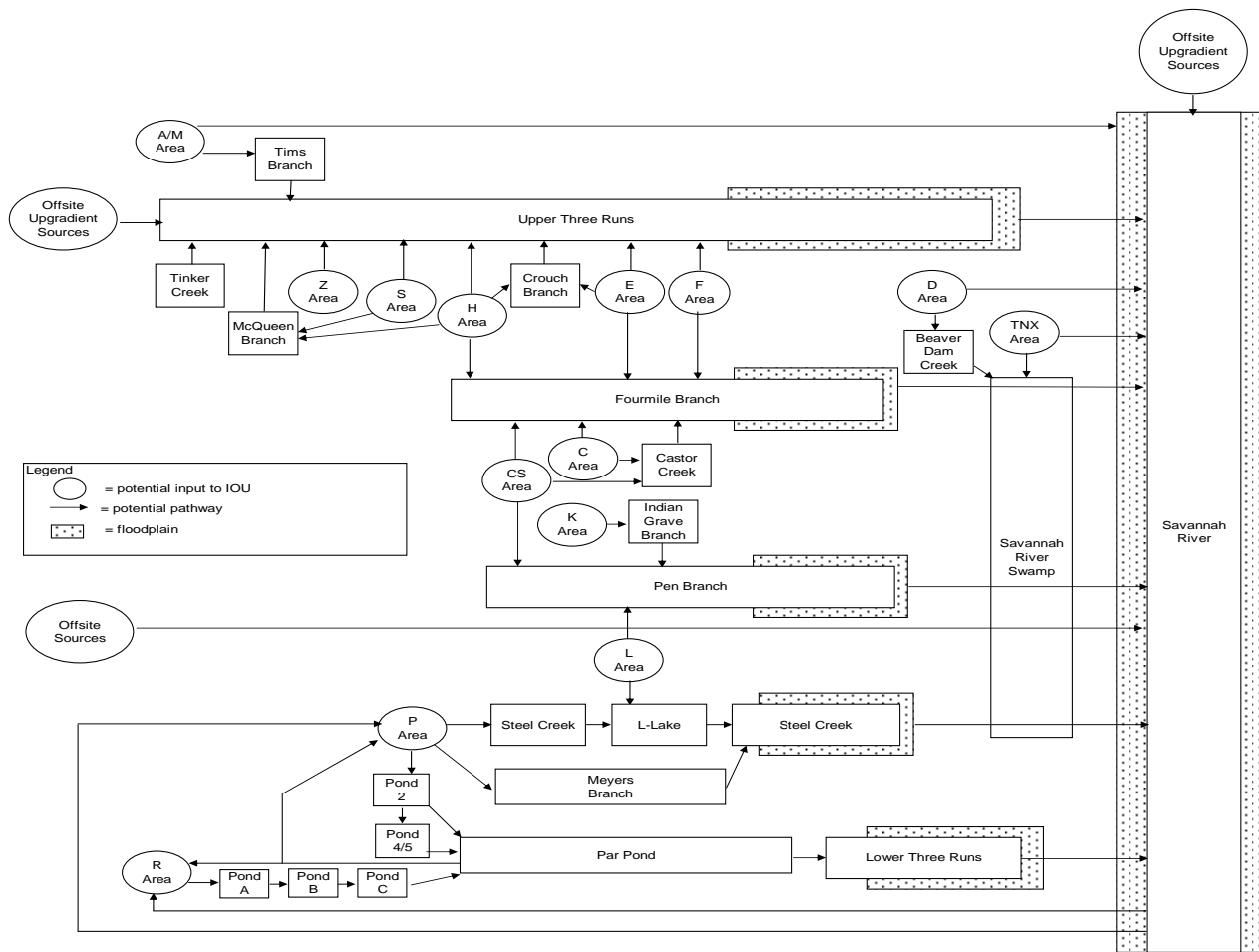

Figure 4.0. SRS Sitewide Conceptual Site Model

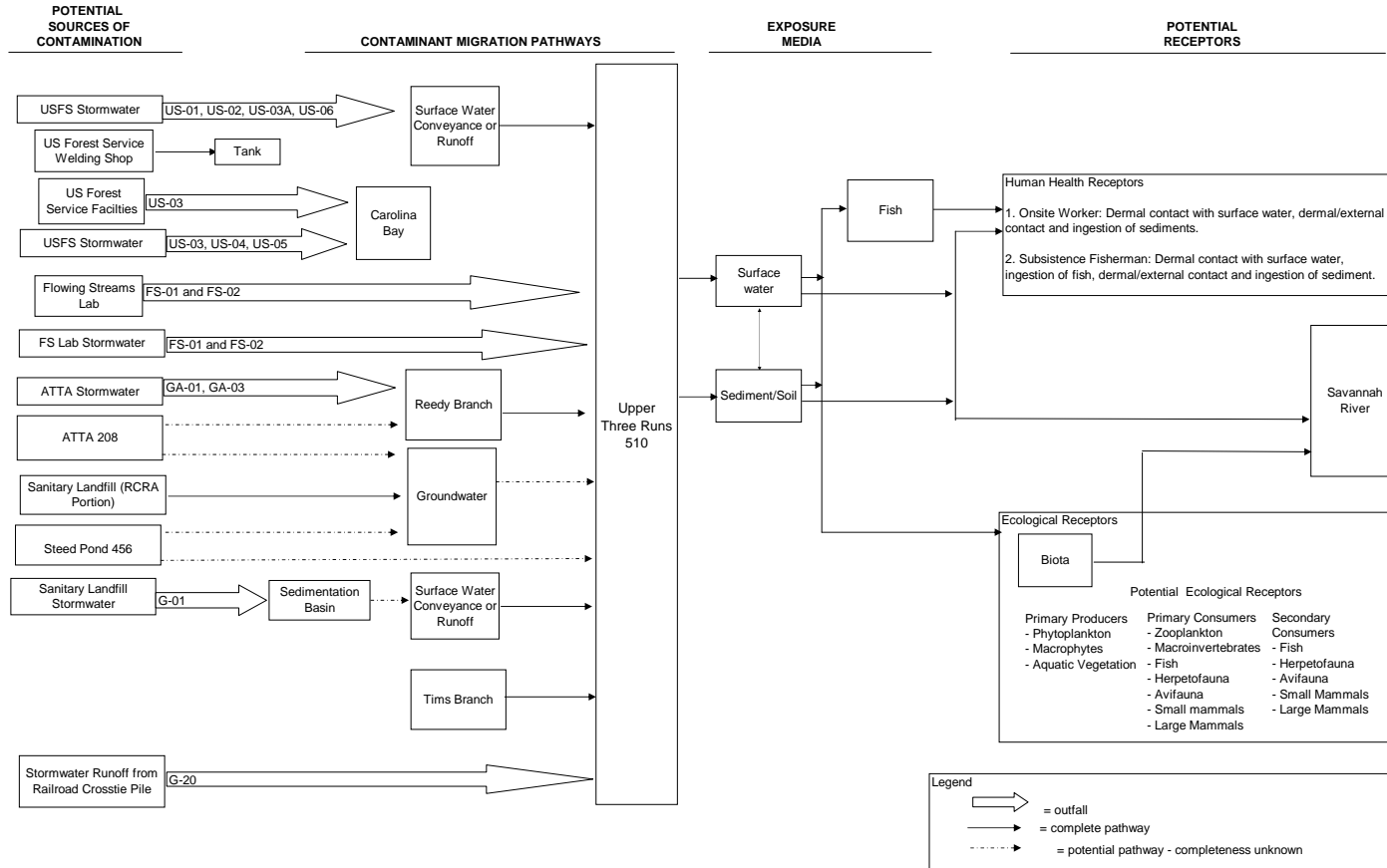

Figure 4.1b Upper Three Runs Watershed/IOU G-Area Conceptual Site Model

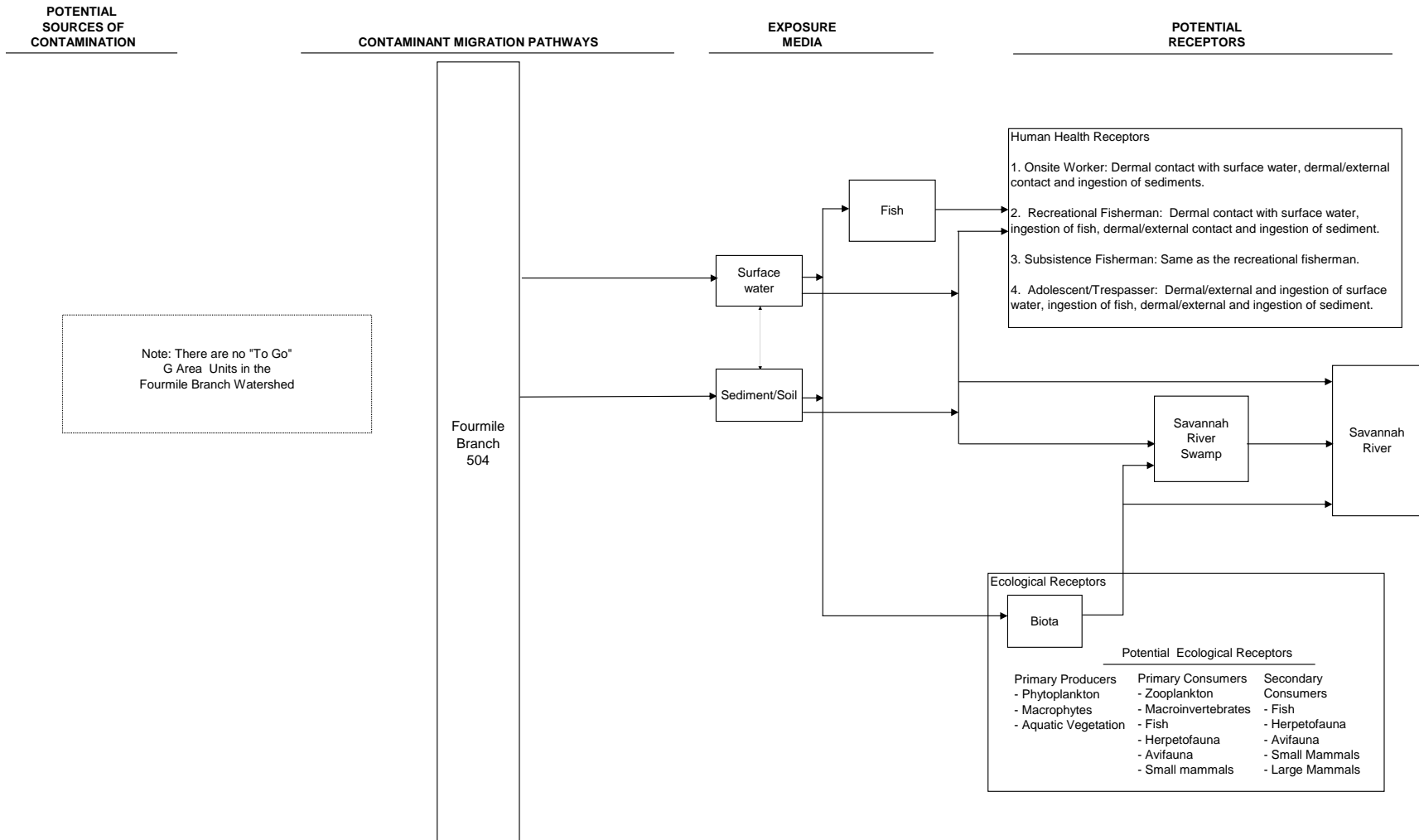

Figure 4.2b Fourmile Branch Watershed G Area IOU

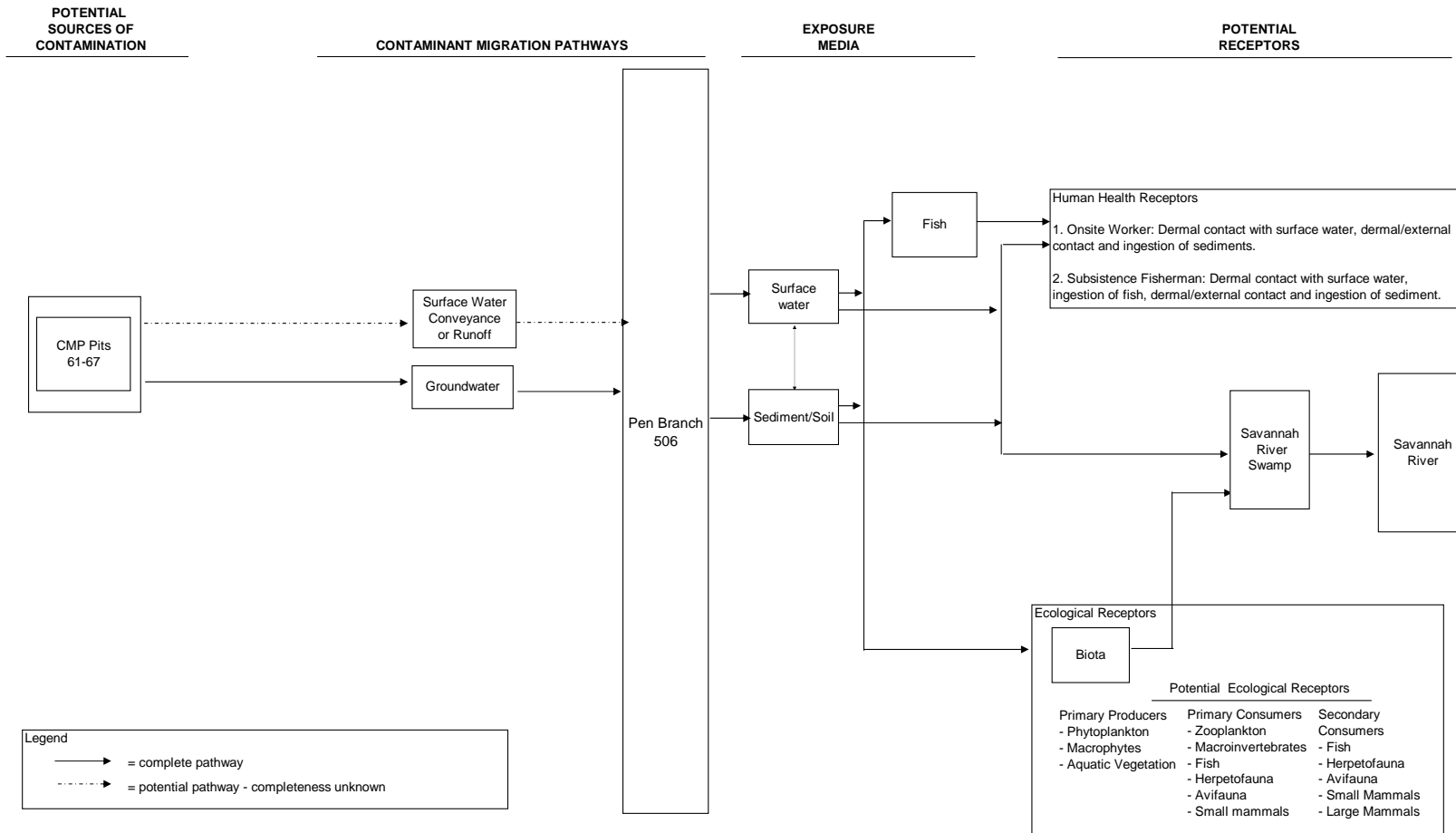

Figure 4.3b Pen Branch Watershed G Area Conceptual Site Model

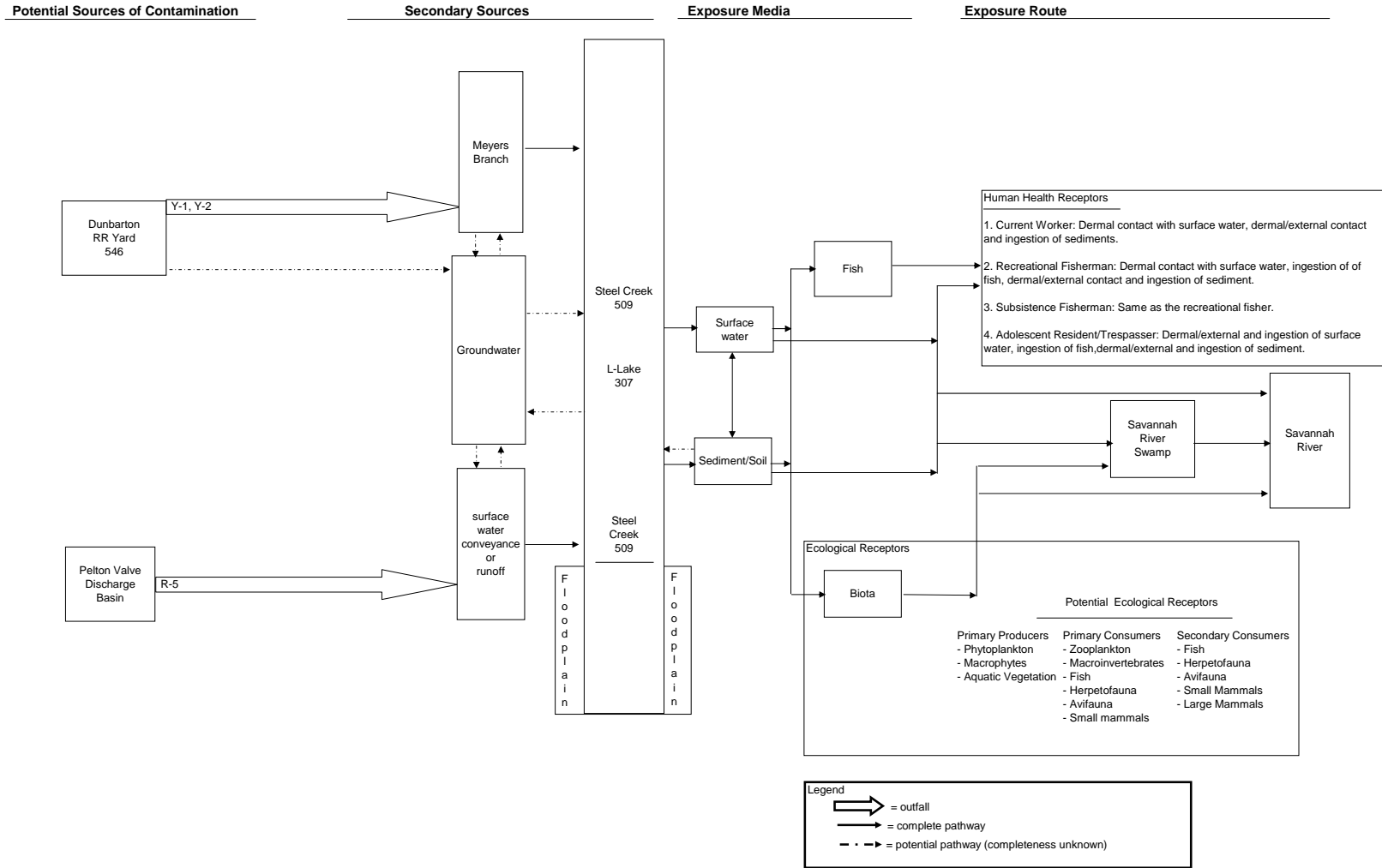

Figure 4.4b. Steel Creek Watershed/IOU G Area Conceptual Site Model

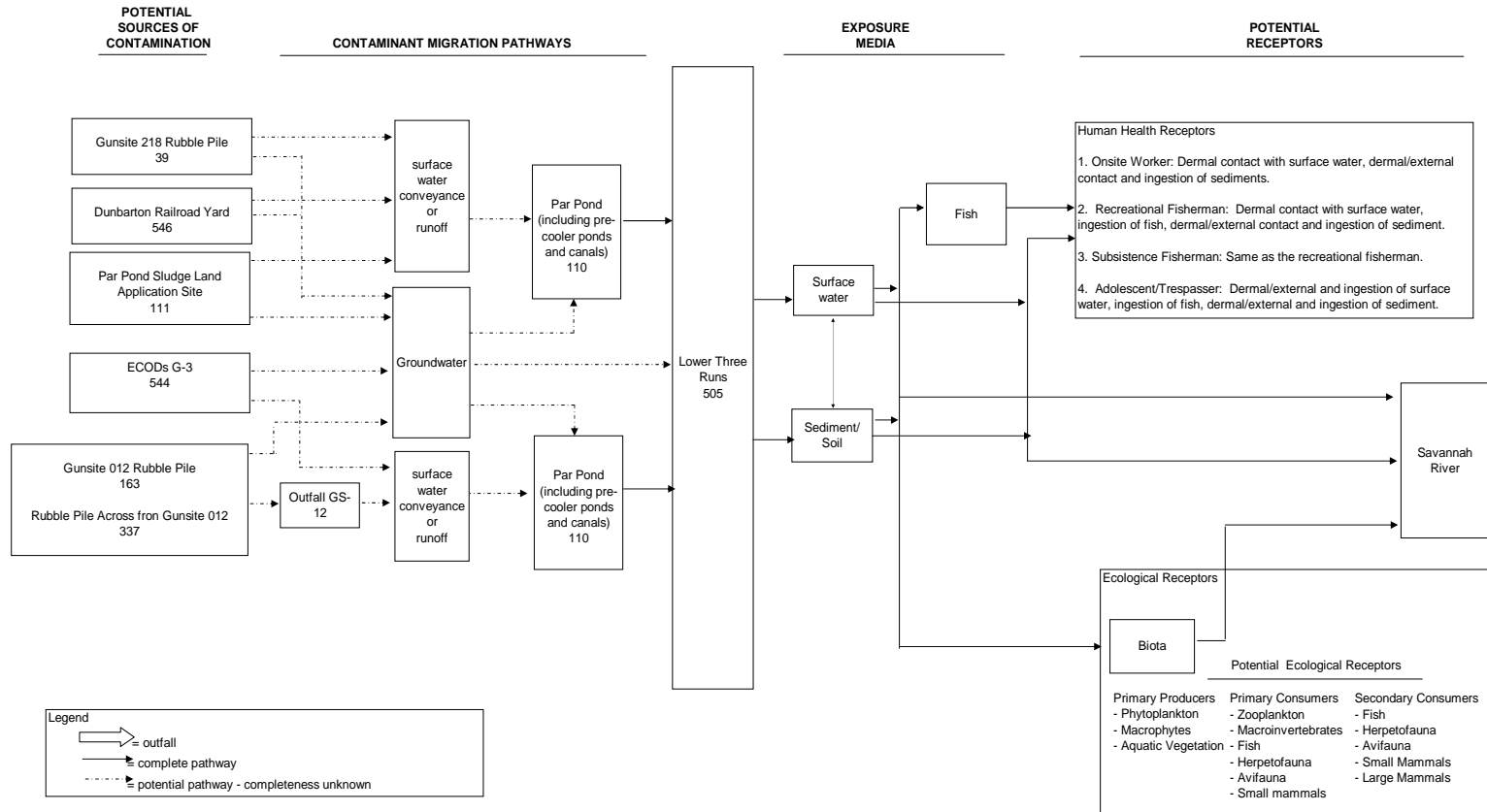

Figure 4.5b Lower Three Runs Watershed G Area Conceptual Site Model

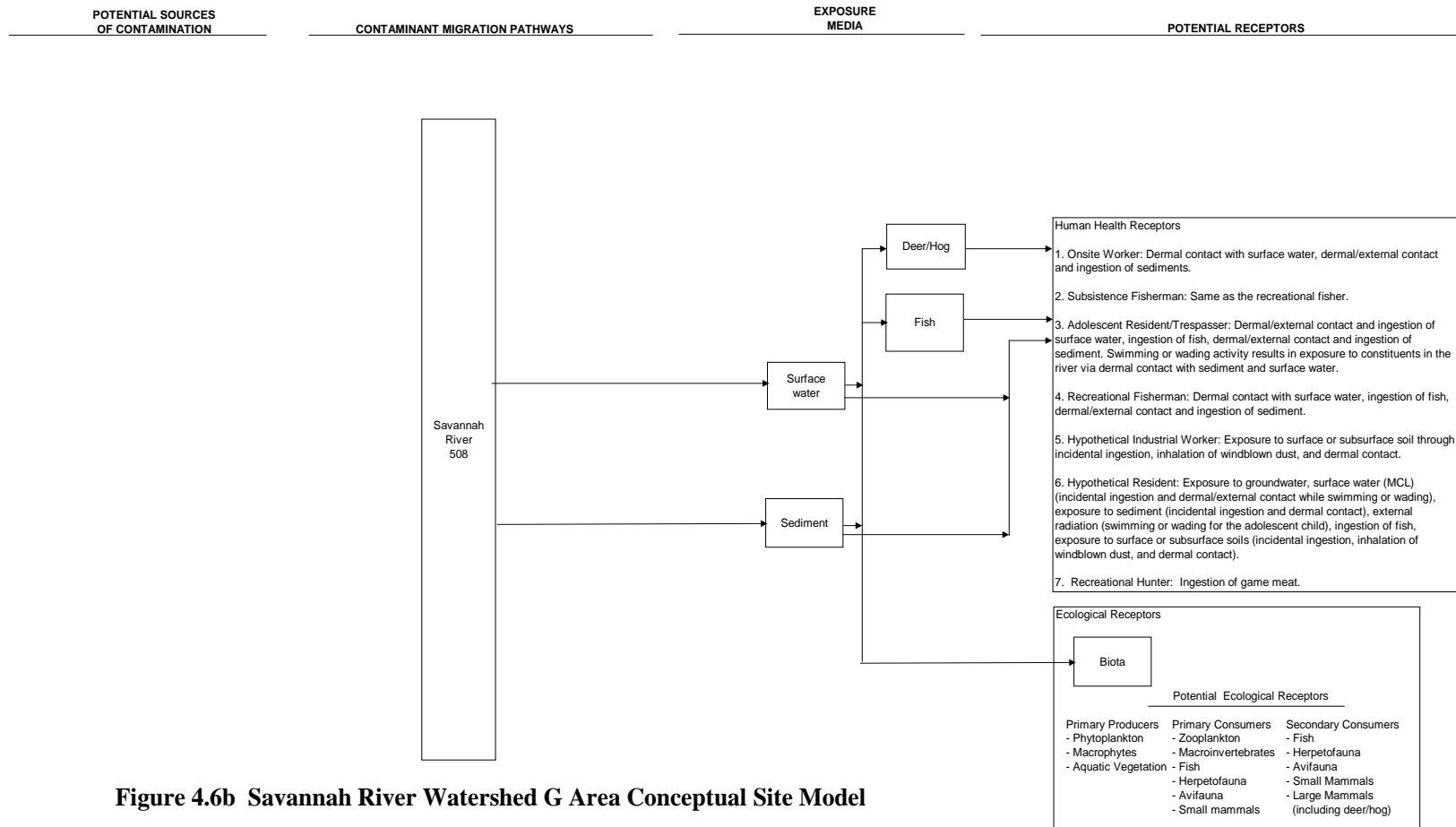

Figure 4.6b Savannah River Watershed G Area Conceptual Site Model

Table 4.1a*
ESV Planned End State for Waste Units in Watersheds (G-Area Only)

* Data consistent w/ 2004 PMP

Unit Index #	Unit Name	Watershed	Facility Area	FY03 Estimated Risk	Status	Institutional Controls in Place	Waste Unit Group (Hazard Type)	Soil Remedial Action	Groundwater Remedial Action (NA)
SRS unique waste unit number	Unit Name with facility or building number (NBN = no building number).	One of six SRS Watersheds where the unit resides.	Specific SRS geographic area unit resides.	Relative level of risk to a receptor from the unit, with 10^{-6} being the lowest level and >>>10^{-4} being the greatest.	Status of unit in the regulatory cleanup process.	Units checked have SRS controls in place to restrict inappropriate uses of land or facilities when contaminants remain at the unit.	One of 11 generic hazard types used to categorize all SRS waste units. (Definitions in Appendix K.)	Remedial action in place for soils media. (Alpha numerics correspond to actions defined in Appendix K; check mark denotes remedial action as yet to be determined.)	Remedial action in place for groundwater media. (Alpha numerics correspond to actions defined in Appendix K; check mark denotes remedial action as yet to be determined.)
154	ABANDONED DRUMS AT STEAM LINE ROAD	Fourmile Branch	G	< 10-6	Complete		5	A.1	
175	OLD STILL SITE, NBN	Fourmile Branch	G	< 10-6	Complete		5	A.1	
125	ROAD A CHEMICAL BASIN, 904-111G	Fourmile Branch	G	< 10-6	Complete		6	A.1	
504	FOURMILE BRANCH INTEGRATOR OPERABLE UNIT (INCLUDING THE UN-NAMED TRIBUTARY OF FOURMILE BRANCH SOUTH OF C AREA	Fourmile Branch	G	> 10-4	In Assessment Phase		11		√
173	MISCELLANEOUS TRASH AT SNAPP, NBN	Lower Three Runs	G	< 10-6	Complete		5	A.1	
177	POND B DAM RUBBLE PILE, NBN	Lower Three Runs	G	< 10-6	Complete		5	A.1	
321	PATTERSON MILL ROAD RUBBLE PILE, NBN	Lower Three Runs	G	< 10-6	Complete		5	A.1	
455	STADIA LIGHTS WITH POLES, NBN	Lower Three Runs	G	< 10-6	Complete		5	A.1	
152	SECOND PAR POND SITE, 761-8G	Lower Three Runs	G	< 10-6	Complete		9	A.1	
39	GUNSITE 218 RUBBLE PILE, 631-23G	Lower Three Runs	G	10-4 to 10-6	In Assessment		5	√	

Table 4.1a*
ESV Planned End State for Waste Units in Watersheds (G-Area Only)

* Data consistent w/ 2004 PMP

Unit Index #	Unit Name	Watershed	Facility Area	FY03 Estimated Risk	Status	Institutional Controls in Place	Waste Unit Group (Hazard Type)	Soil Remedial Action	Groundwater Remedial Action (NA)
SRS unique waste unit number	Unit Name with facility or building number (NBN = no building number).	One of six SRS Watersheds where the unit resides.	Specific SRS geographic area unit resides.	Relative level of risk to a receptor from the unit, with $<10^{-6}$ being the lowest level and $>>10^{-4}$ being the greatest.	Status of unit in the regulatory cleanup process.	Units checked have SRS controls in place to restrict inappropriate uses of land or facilities when contaminants remain at the unit.	One of 11 generic hazard types used to categorize all SRS waste units. (Definitions in Appendix K.)	Remedial action in place for soils media. (Alpha numerics correspond to actions defined in Appendix K; check mark denotes remedial action as yet to be determined.)	Remedial action in place for groundwater media. (Alpha numerics correspond to actions defined in Appendix K; check mark denotes remedial action as yet to be determined.)
					Phase				
163	GUNSITE 012 RUBBLE PILE, NBN	Lower Three Runs	G	10-4 to 10-6	In Assessment Phase		5	√	
337	RUBBLE PILE ACROSS FROM GUNSITE 012, NBN	Lower Three Runs	G	10-4 to 10-6	In Assessment Phase		5	√	
544	ECODS G-3 (ADJACENT TO GUNSITE 012, NBN)	Lower Three Runs	G	10-4 to 10-6	In Assessment Phase		5	√	
111	PAR POND SLUDGE LAND APPLICATION SITE, 761-5G	Lower Three Runs	G	10-4 to 10-6	In Assessment Phase		7	√	
505	LOWER THREE RUNS INTEGRATOR OPERABLE UNIT	Lower Three Runs	G	> 10-4	In Assessment Phase		11	√	
110	PAR POND (INCLUDING THE PRE-COOLER PONDS AND CANALS), 685-G	Lower Three Runs	G	> 10-4	In Remediation		9	√	
291	GUNSITE 051 RUBBLE PILE, 080-29G	Pen Branch	G	< 10-6	Complete		5	A.1	
153	40 - ACRE HARDWOOD SITE, 761-0G	Pen Branch	G	< 10-6	Complete		9	A.1	

Table 4.1a*
ESV Planned End State for Waste Units in Watersheds (G-Area Only)

* Data consistent w/ 2004 PMP

Unit Index #	Unit Name	Watershed	Facility Area	FY03 Estimated Risk	Status	Institutional Controls in Place	Waste Unit Group (Hazard Type)	Soil Remedial Action	Groundwater Remedial Action (NA)
SRS unique waste unit number	Unit Name with facility or building number (NBN = no building number).	One of six SRS Watersheds where the unit resides.	Specific SRS geographic area unit resides.	Relative level of risk to a receptor from the unit, with 10^{-6} being the lowest level and >>>10^{-4} being the greatest.	Status of unit in the regulatory cleanup process.	Units checked have SRS controls in place to restrict inappropriate uses of land or facilities when contaminants remain at the unit.	One of 11 generic hazard types used to categorize all SRS waste units. (Definitions in Appendix K.)	Remedial action in place for soils media. (Alpha numerics correspond to actions defined in Appendix K; check mark denotes remedial action as yet to be determined.)	Remedial action in place for groundwater media. (Alpha numerics correspond to actions defined in Appendix K; check mark denotes remedial action as yet to be determined.)
506	PEN BRANCH INTEGRATOR OPERABLE UNIT (INCLUDING INDIAN GRAVE BRANCH)	Pen Branch	G	> 10-4	In Assessment Phase		11		√
61	CMP PITS, 080-170G	Pen Branch	G	> 10-4	In Remediation		5	√	√
62	CMP PITS, 080-171G	Pen Branch	G	> 10-4	In Remediation		5	√	√
63	CMP PITS, 080-180G	Pen Branch	G	> 10-4	In Remediation		5	√	√
64	CMP PITS, 080-181G	Pen Branch	G	> 10-4	In Remediation		5	√	√
65	CMP PITS, 080-182G	Pen Branch	G	> 10-4	In Remediation		5	√	√
66	CMP PITS, 080-183G	Pen Branch	G	> 10-4	In Remediation		5	√	√
67	CMP PITS, 080-190G	Pen Branch	G	> 10-4	In Remediation		5	√	√
174	OLD ELLENTON RUBBLE PILE, NBN	Savannah River / Floodplain / Swamp	G	< 10-6	Complete		5	A.1	
336	ROBBINS STATION ROAD RUBBLE PILE, NBN	Savannah River / Floodplain /	G	< 10-6	Complete		5	A.1	

Table 4.1a*
ESV Planned End State for Waste Units in Watersheds (G-Area Only)

* Data consistent w/ 2004 PMP

Unit Index #	Unit Name	Watershed	Facility Area	FY03 Estimated Risk	Status	Institutional Controls in Place	Waste Unit Group (Hazard Type)	Soil Remedial Action	Groundwater Remedial Action (NA)
SRS unique waste unit number	Unit Name with facility or building number (NBN = no building number).	One of six SRS Watersheds where the unit resides.	Specific SRS geographic area unit resides.	Relative level of risk to a receptor from the unit, with 10^{-6} being the lowest level and >>>10^{-4} being the greatest.	Status of unit in the regulatory cleanup process.	Units checked have SRS controls in place to restrict inappropriate uses of land or facilities when contaminants remain at the unit.	One of 11 generic hazard types used to categorize all SRS waste units. (Definitions in Appendix K.)	Remedial action in place for soils media. (Alpha numerics correspond to actions defined in Appendix K; check mark denotes remedial action as yet to be determined.)	Remedial action in place for groundwater media. (Alpha numerics correspond to actions defined in Appendix K; check mark denotes remedial action as yet to be determined.)
		Swamp							
160	D-F STEAMLINE EROSION CONTROL SITE, NBN	Savannah River / Floodplain / Swamp	G	<math>< 10^{-6}</math>	Complete		9	A.1	
226	SPILL ON 03/08/88 OF <math>< 1</math> QT OF 64% NITRIC ACID AT BRCD. 1, NBN	Savannah River / Floodplain / Swamp	G	<math>< 10^{-6}</math>	Complete		9	A.1	
235	3G PUMPHOUSE EROSION CONTROL SITE, 631-8G	Savannah River / Floodplain / Swamp	G	<math>< 10^{-6}</math>	Complete		9	A.1	
320	PARKING LOT TYPE LIGHTS ON WILSON ROAD, NBN	Savannah River / Floodplain / Swamp	G	<math>< 10^{-6}</math>	Complete		9	A.1	
430	SPILL ON 05/27/86 OF 2 GAL OF NITRIC ACID, NBN	Savannah River / Floodplain / Swamp	G	<math>< 10^{-6}</math>	Complete		9	A.1	
508	SAVANNAH RIVER FLOODPLAIN SWAMP INTEGRATOR OPERABLE UNIT (INCLUDING STEEL CREEK SWAMP AND BEAVER DAM CREEK)	Savannah River / Floodplain / Swamp	G	> 10^{-4}	In Assessment Phase		11		√

Table 4.1a*
ESV Planned End State for Waste Units in Watersheds (G-Area Only)

* Data consistent w/ 2004 PMP

Unit Index #	Unit Name	Watershed	Facility Area	FY03 Estimated Risk	Status	Institutional Controls in Place	Waste Unit Group (Hazard Type)	Soil Remedial Action	Groundwater Remedial Action (NA)
SRS unique waste unit number	Unit Name with facility or building number (NBN = no building number).	One of six SRS Watersheds where the unit resides.	Specific SRS geographic area unit resides.	Relative level of risk to a receptor from the unit, with 10^{-6} being the lowest level and >>>10^{-4} being the greatest.	Status of unit in the regulatory cleanup process.	Units checked have SRS controls in place to restrict inappropriate uses of land or facilities when contaminants remain at the unit.	One of 11 generic hazard types used to categorize all SRS waste units. (Definitions in Appendix K.)	Remedial action in place for soils media. (Alpha numerics correspond to actions defined in Appendix K; check mark denotes remedial action as yet to be determined.)	Remedial action in place for groundwater media. (Alpha numerics correspond to actions defined in Appendix K; check mark denotes remedial action as yet to be determined.)
171	MEYERS MILL SIDING RUBBLE PILE, NBN	Steel Creek	G	<math>< 10^{-6}</math>	Complete		5	A.1	
172	MISCELLANEOUS RUBBLE AT DUNBARTON, NBN	Steel Creek	G	<math>< 10^{-6}</math>	Complete		5	A.1	
192	SCRAP METAL PILE, 631-18G	Steel Creek	G	<math>< 10^{-6}</math>	Complete		5	A.1	
334	ROAD 9 AT GATE 23 RUBBLE PILE, NBN	Steel Creek	G	<math>< 10^{-6}</math>	Complete		5	A.1	
335	ROAD 9 RUBBLE PILE, NBN	Steel Creek	G	<math>< 10^{-6}</math>	Complete		5	A.1	
518	GUN EMPLACEMENT 407A & 407B RUBBLE PILE, NBN	Steel Creek	G	<math>< 10^{-6}</math>	Complete		5	A.1	
546	DUNBARTON RAILROAD YARD, NBN	Steel Creek	G	10^{-4} to 10^{-6}	In Assessment Phase		5	√	
307	L LAKE, NBN	Steel Creek	G	> 10^{-4}	In Assessment Phase	√	9		√
509	STEEL CREEK INTEGRATOR OPERABLE UNIT	Steel Creek	G	> 10^{-4}	In Assessment Phase		11		√
40	GUNSITE 720 RUBBLE PIT, 631-16G	Upper Three Runs	G	<math>< 10^{-6}</math>	Complete		5	A.1	

Table 4.1a*
ESV Planned End State for Waste Units in Watersheds (G-Area Only)

* Data consistent w/ 2004 PMP

Unit Index #	Unit Name	Watershed	Facility Area	FY03 Estimated Risk	Status	Institutional Controls in Place	Waste Unit Group (Hazard Type)	Soil Remedial Action	Groundwater Remedial Action (NA)
SRS unique waste unit number	Unit Name with facility or building number (NBN = no building number).	One of six SRS Watersheds where the unit resides.	Specific SRS geographic area unit resides.	Relative level of risk to a receptor from the unit, with 10^{-6} being the lowest level and >>>10^{-4} being the greatest.	Status of unit in the regulatory cleanup process.	Units checked have SRS controls in place to restrict inappropriate uses of land or facilities when contaminants remain at the unit.	One of 11 generic hazard types used to categorize all SRS waste units. (Definitions in Appendix K.)	Remedial action in place for soils media. (Alpha numerics correspond to actions defined in Appendix K; check mark denotes remedial action as yet to be determined.)	Remedial action in place for groundwater media. (Alpha numerics correspond to actions defined in Appendix K; check mark denotes remedial action as yet to be determined.)
164	GUNSITE 102 RUBBLE PILE, 080-30G	Upper Three Runs	G	<math>< 10^{-6}</math>	Complete		5	A.1	
165	GUNSITE 113 RUBBLE PILE, 631-15G	Upper Three Runs	G	<math>< 10^{-6}</math>	Complete		5	A.1	
180	RECREATION AREA #002 RUBBLE PILE, NBN	Upper Three Runs	G	<math>< 10^{-6}</math>	Complete		5	A.1	
182	RUBBLE PILE - BRAGG BAY ROAD, 631-14G	Upper Three Runs	G	<math>< 10^{-6}</math>	Complete		5	A.1	
183	RUBBLE PILE - BRAGG BAY ROAD AND CEMETERY ROAD, 631-12G	Upper Three Runs	G	<math>< 10^{-6}</math>	Complete		5	A.1	
184	RUBBLE PILE - CEMETERY ROAD, 631-11G	Upper Three Runs	G	<math>< 10^{-6}</math>	Complete		5	A.1	
185	RUBBLE PILE - ROAD 781.1, 631-13G	Upper Three Runs	G	<math>< 10^{-6}</math>	Complete		5	A.1	
186	RUBBLE PILE NEAR JUNCTION US 278 & GE ROAD 103, NBN	Upper Three Runs	G	<math>< 10^{-6}</math>	Complete		5	A.1	
202	SREL RUBBLE PILE, 761-9G	Upper Three Runs	G	<math>< 10^{-6}</math>	Complete		5	A.1	
203	SRFS RUBBLE PILE, 631-9G	Upper Three Runs	G	<math>< 10^{-6}</math>	Complete		5	A.1	

Table 4.1a*
ESV Planned End State for Waste Units in Watersheds (G-Area Only)

* Data consistent w/ 2004 PMP

Unit Index #	Unit Name	Watershed	Facility Area	FY03 Estimated Risk	Status	Institutional Controls in Place	Waste Unit Group (Hazard Type)	Soil Remedial Action	Groundwater Remedial Action (NA)
SRS unique waste unit number	Unit Name with facility or building number (NBN = no building number).	One of six SRS Watersheds where the unit resides.	Specific SRS geographic area unit resides.	Relative level of risk to a receptor from the unit, with 10^{-6} being the lowest level and >>>10^{-4} being the greatest.	Status of unit in the regulatory cleanup process.	Units checked have SRS controls in place to restrict inappropriate uses of land or facilities when contaminants remain at the unit.	One of 11 generic hazard types used to categorize all SRS waste units. (Definitions in Appendix K.)	Remedial action in place for soils media. (Alpha numerics correspond to actions defined in Appendix K; check mark denotes remedial action as yet to be determined.)	Remedial action in place for groundwater media. (Alpha numerics correspond to actions defined in Appendix K; check mark denotes remedial action as yet to be determined.)
213	GUNSITE 072 RUBBLE PILE, 080-31G	Upper Three Runs	G	<math>< 10^{-6}</math>	Complete		5	A.1	
216	RISHER ROAD OPEN METAL PIT, 631-17G	Upper Three Runs	G	<math>< 10^{-6}</math>	Complete		5	A.1	
217	RISHER ROAD RUBBLE PILE, NBN	Upper Three Runs	G	<math>< 10^{-6}</math>	Complete		5	A.1	
218	RISHER ROAD RUBBLE PILE #2, NBN	Upper Three Runs	G	<math>< 10^{-6}</math>	Complete		5	A.1	
333	ROAD 3 FOUNDATION RUBBLE PILE, NBN	Upper Three Runs	G	<math>< 10^{-6}</math>	Complete		5	A.1	
541	ECODS G-1 (ADJACENT TO GUNSITE 072 RUBBLE PILE, 080-31G)	Upper Three Runs	G	<math>< 10^{-6}</math>	Complete		5	A.2, A.3, A.7	
542	ECODS G-2 (ADJACENT TO FORESTRY FACILITIES)	Upper Three Runs	G	<math>< 10^{-6}</math>	Complete		5	A.1	
140	WEST OF SREL "GEORGIA FIELDS" SITE, 631-19G	Upper Three Runs	G	<math>< 10^{-6}</math>	Complete		9	A.1	
150	LUCY SITE, 761-3G	Upper Three Runs	G	<math>< 10^{-6}</math>	Complete		9	A.1	
181	ROAD F SITE, 761-7G	Upper Three Runs	G	<math>< 10^{-6}</math>	Complete		9	A.1	
205	INCIDENT AT THREE RIVERS SANITARY LANDFILL, NBN	Upper Three Runs	G	<math>< 10^{-6}</math>	Complete		9	A.1	

Table 4.1a*
ESV Planned End State for Waste Units in Watersheds (G-Area Only)

* Data consistent w/ 2004 PMP

Unit Index #	Unit Name	Watershed	Facility Area	FY03 Estimated Risk	Status	Institutional Controls in Place	Waste Unit Group (Hazard Type)	Soil Remedial Action	Groundwater Remedial Action (NA)
SRS unique waste unit number	Unit Name with facility or building number (NBN = no building number).	One of six SRS Watersheds where the unit resides.	Specific SRS geographic area unit resides.	Relative level of risk to a receptor from the unit, with 10^{-6} being the lowest level and >>>10^{-4} being the greatest.	Status of unit in the regulatory cleanup process.	Units checked have SRS controls in place to restrict inappropriate uses of land or facilities when contaminants remain at the unit.	One of 11 generic hazard types used to categorize all SRS waste units. (Definitions in Appendix K.)	Remedial action in place for soils media. (Alpha numerics correspond to actions defined in Appendix K; check mark denotes remedial action as yet to be determined.)	Remedial action in place for groundwater media. (Alpha numerics correspond to actions defined in Appendix K; check mark denotes remedial action as yet to be determined.)
463	SUBSTATION 51 EROSION CONTROL SITE, 080-27G	Upper Three Runs	G	10^{-6}	Complete		9	A.1	
38	GUNSITE 113 ACCESS ROAD, 631-24G	Upper Three Runs	G	10^{-6}	Complete		5	A.1	
456	STEED POND, NBN	Upper Three Runs	G	> 10^{-4}	In Assessment Phase		2	√	
208	ADVANCED TACTICAL TRAINING AREA (ATTA) FIRING RANGES, NBN	Upper Three Runs	G	10-4 to 10-6	In Assessment Phase		9	√	
510	UPPER THREE RUNS INTEGRATOR OPERABLE UNIT (INCLUDING TIMS BRANCH)	Upper Three Runs	G	> 10^{-4}	In Assessment Phase		11		√

Table 4.1b*						
EM Integrated Deactivation and Decommissioning Plan (G Area Only)						* Data consistent w/ 2004 PMP
Unit No	Bldg No	Hazard	Facility Area	Status	Current Risk	
		Name			Conceptual Site Model Hazard	Decommissioning Alternative
1434	504-1G	SWITCHING STATION	G	Other	Other Industrial	Demolish
1435	504-2G	SWITCHING STATION	G	Other	Other Industrial	Demolish
1436	504-3G	SWITCHING STATION	G	Other	Other Industrial	Demolish
1470	607-59G	CHEM FEED BLDG WSTWTR TRTMNT EQPM	G	Other	Other Industrial	Demolish
1471	607-62G	INFLUENT HEADWRKS FOR WASTEWATER TREATMENT EQPMN	G	Other	Other Industrial	Demolish
1472	607-63G	EQUALIZATION BASIN WSTWTR TRTMNT EQPM	G	Other	Other Industrial	ISD/IC/LTS
1473	607-64G	EQUALIZATION BASIN WSTWTR TRTMNT EQPM	G	Other	Other Industrial	ISD/IC/LTS
1474	607-65G	PUMP STA 4000B WSTWTR TRTMNT FAC	G	Other	Other Industrial	ISD/IC/LTS
1475	607-66G	PUMP STA 4000C WSTWTR TRTMNT FAC	G	Other	Other Industrial	ISD/IC/LTS
1476	607-67G	PUMP STA5000A WSTWTR TRTMNT FAC	G	Other	Other Industrial	ISD/IC/LTS
1477	607-68G	PUMP STA 6000A WSTWTR TRTMNT FAC	G	Other	Other Industrial	ISD/IC/LTS
1478	607-70G	OXIDATN DITCH & CLAR #1 WSTWTR TRTMNT EQPM	G	Other	Other Industrial	ISD/IC/LTS
1479	607-71G	OXIDATN DITCH CLAR#2 WSTWTR TREATMNT EQPM	G	Other	Other Industrial	ISD/IC/LTS
1480	607-72G	OXIDATN DITCH & CLAR #3 WASTWTR TRTMNT EQP	G	Other	Other Industrial	ISD/IC/LTS

Table 4.1b*						
EM Integrated Deactivation and Decommissioning Plan (G Area Only)						* Data consistent w/ 2004 PMP
		Hazard			Current Risk	
Unit No	Bldg No	Name	Facility Area	Status	Conceptual Site Model Hazard	Decommissioning Alternative
1481	607-74G	UV DISINFCTN BSN CASCDE UNIT WSTWTR TRTMNT	G	Other	Other Industrial	ISD/IC/LTS
1482	607-75G	SLUDGE THICKENER WSTWTR TRTMNT EQP	G	Other	Other Industrial	Demolish
1484	607-85G	PUMP STATION 2000B WSTWTR TRTMNT FAC	G	Other	Other Industrial	ISD/IC/LTS
1485	607-86G	PUMP STN 3000A WASTEWATER TREATMENT FACL	G	Other	Other Industrial	ISD/IC/LTS
1486	607-87G	PUMP STN 4000A WASTEWATER TREATMENT FACL	G	Other	Chemical - Low Hazard	ISD/IC/LTS
1487	607-88G	CSWTF MAINTENANCE BUILDING	G	Other	Other Industrial	Demolish
1488	607-91G	SANITARY SEWAGE PUMP STATION	G	Other	Never Contaminated	ISD/IC/LTS
1491	608-G	TRACK SCALE HOUSE	G	Other	Never Contaminated	Demolish
1492	609-G	TRACK MAINTENANCE BUILDING	G	Other	Never Contaminated	Demolish
1497	614-48G	WIND DATA BUILDING-N OF A-AREA	G	Other	Never Contaminated	Demolish
1498	614-50G	WIND DATA BUILDING-N-NW OF H-AREA	G	Other	Never Contaminated	Demolish
1499	614-51G	WIND DATA BUILDING-E-SE OF F-AREA	G	Other	Never Contaminated	Demolish
1500	614-52G	WIND DATA BUILDING-S-SE OF C-AREA	G	Other	Never Contaminated	Demolish
1501	614-53G	WIND DATA BUILDING-E-SE OF K-AREA	G	Other	Never Contaminated	Demolish
1502	614-54G	WIND DATA BUILDING-SE OF P-AREA	G	Other	Never Contaminated	Demolish

Table 4.1b* EM Integrated Deactivation and Decommissioning Plan (G Area Only) * Data consistent w/ 2004 PMP						
Unit No	Bldg No	Hazard	Facility Area	Status	Current Risk	
		Name			Conceptual Site Model Hazard	Decommissioning Alternative
1503	614-55G	WIND DATA BUILDING-E OF L-AREA	G	Other	Never Contaminated	Demolish
1504	614-56G	EQUIPMENT SHED	G	Other	Never Contaminated	Demolish
1505	614-57G	EQUIPMENT SHED	G	Other	Never Contaminated	Demolish
1506	614-58G	EQUIPMENT SHED	G	Other	Never Contaminated	Demolish
1507	614-59G	EQUIPMENT SHED	G	Other	Never Contaminated	Demolish
1508	614-60G	EQUIPMENT SHED	G	Other	Never Contaminated	Demolish
1509	614-61G	EQUIPMENT SHED	G	Other	Never Contaminated	Demolish
1510	614-62G	EQUIPMENT SHED	G	Other	Never Contaminated	Demolish
1511	614-63G	EQUIPMENT SHED	G	Other	Never Contaminated	Demolish
1512	614-65G	EQUIPMENT SHED	G	Other	Never Contaminated	Demolish
1513	614-66G	EQUIPMENT SHED	G	Other	Never Contaminated	Demolish
1514	614-67G	EQUIPMENT SHED	G	Other	Never Contaminated	Demolish
1515	617-G	SECURITY CLASS ROOM	G	Other	Other Industrial	Demolish
1516	618-G	LOCOMOTIVE SHOP	G	Other	Other Industrial	Demolish
1518	623-30G	COMMUNICATIONS FACILITY	G	Other	Never Contaminated	Demolish

Table 4.1b*						
EM Integrated Deactivation and Decommissioning Plan (G Area Only)						* Data consistent w/ 2004 PMP
Unit No	Bldg No	Hazard	Facility Area	Status	Current Risk	
		Name			Conceptual Site Model Hazard	Decommissioning Alternative
1519	623-40G	RADIO TRUNKING TOWER	G	Other	Never Contaminated	Demolish
1531	647-G	WAREHOUSE	G	Other	Other Industrial	Demolish
1532	651-1G	PRIMARY TRANSFORMER SUBSTATION/681-1G	G	Other	Other Industrial	Demolish
1533	651-3G	PRIMARY TRANSFORMER SUBSTATION/681-3G	G	Other	Other Industrial	Demolish
1534	651-6G	PRIMARY TRANSFORMER SUBSTATION/681-6G	G	Other	Other Industrial	Demolish
1537	652-53G	EMERG TRNS WSTEWTR TRTMT EQUIP (WAS 654001G)	G	Other	Never Contaminated	Demolish
1548	661-2G	FIRING SHED	G	Other	Never Contaminated	Demolish
1550	661-G	PATROL TRAINING BLDG-RIFLE & PISTOL RANGE	G	Other	Other Industrial	Demolish
1565	681-1G	UP-STREAM WATER PUMP HOUSE FOR 100 AREAS	G	Other	Other Industrial	Demolish
1566	681-23G	CHLORINE BUILDING	G	Other	Other Industrial	Demolish
1567	681-3G	DOWN-STREAM WATER PUMP HOUSE FOR 100AREA	G	Other	Other Industrial	Demolish
1568	681-5G	WATER PUMP HOUSE FOR 400 AREA	G	Other	Other Industrial	Demolish
1569	681-6G	PAR POND PUMP HOUSE	G	Other	Other Industrial	Demolish
1570	681-7G	PUMP HOUSE EQUIP BLDG-ADJACENT TO 681-6G	G	Other	Other Industrial	Demolish
1571	681-G	WELLHSE & HYDROPNEUMATIC TANK WASTWTR TREATMNT E	G	Other	Never Contaminated	Demolish

Table 4.1b* EM Integrated Deactivation and Decommissioning Plan (G Area Only) * Data consistent w/ 2004 PMP						
Unit No	Bldg No	Hazard	Facility Area	Status	Current Risk	
		Name			Conceptual Site Model Hazard	Decommissioning Alternative
1572	682-1G	ELEVATED WATER STORAGE TANK	G	Other	Never Contaminated	Demolish
1573	682-G	ELEVATED WATER STORAGE TANK	G	Other	Other Industrial	Demolish
1576	686-1G	DAM SERVICE BUILDING	G	Other	Never Contaminated	Demolish
1582	701-12G	GUARDHOUSE HW 125 - RD. 3	G	Other	Never Contaminated	Demolish
1584	701-13G	GUARDHOUSE HW 125 - RD. 6	G	Other	Never Contaminated	Demolish
1586	701-18G	GUARDHOUSE AT RD 1 AND D-1 (PECAN GATE)	G	Other	Never Contaminated	Demolish
1602	701-2G	GATEHOUSE, ALLENDALE ENTRANCE	G	Other	Other Industrial	Demolish
1609	701-4G	GATEHOUSE, WILLISTON ENTRANCE	G	Other	Never Contaminated	Demolish
1611	701-8G	GUARDHOUSE HW 125 - RD. 2	G	Other	Never Contaminated	Demolish
1645	704-16G	ADMIN BUILDING FOR WASTEWATER TREATMENT EQUIPMEN	G	Other	Never Contaminated	Demolish
1697	709-1G	100 AREA FIRE STATION	G	Other	Never Contaminated	Demolish
1698	709-7G	FIRE STATION	G	Other	Chemical - Low Hazard	Demolish
1860	735-7G	ENVIRON. SUPPORT FAC., PAR POND	G	Other	Never Contaminated	Demolish
1861	735-8G	GREENHOUSE	G	Other	Other Industrial	Demolish
1885	737-G	LABORATORY FOR UGA	G	Other	Never Contaminated	Demolish

Table 4.1b* EM Integrated Deactivation and Decommissioning Plan (G Area Only) * Data consistent w/ 2004 PMP						
		Hazard			Current Risk	
Unit No	Bldg No	Name	Facility Area	Status	Conceptual Site Model Hazard	Decommissioning Alternative
1887	739-G	GREENHOUSE FOR THERMAL EFFECTS LAB.	G	Other	Other Industrial	Demolish
1888	740-10G	INTERIM SANITARY LANDFILL	G	Other	Never Contaminated	Demolish
1907	760-11G	SR ARCHAEOLOGICAL HDQTRS.	G	Other	Never Contaminated	Demolish
1908	760-12G	DEER HUNT BUILDING	G	Other	Never Contaminated	Demolish
1909	760-13G	STORAGE BUILDING	G	Other	Never Contaminated	Demolish
1910	760-15G	ADMINISTRATION FACILITY - FOREST SERVICE	G	Other	Never Contaminated	Demolish
1911	760-17G	STORAGE SHELTER	G	Other	Other Industrial	Demolish
1912	760-19G	HEAVY EQUIPMENT STORAGE SHELTER	G	Other	Never Contaminated	Demolish
1913	760-1G	U.S. FOREST SERVICE HEADQUARTERS	G	Other	Never Contaminated	Demolish
1914	760-3G	HUNT ASSY. BLDG.	G	Other	Never Contaminated	Demolish
1915	760-4G	FOREST SERVICE STORAGE BLDG.	G	Other	Never Contaminated	Demolish
1916	760-9G	SR FOREST STATION EQUIP. BLDG.	G	Other	Never Contaminated	Demolish
1917	760-G	U.S. FOREST SERVICE HEADQUARTERS	G	Other	Never Contaminated	Demolish
1924	772-10G	CORE STORAGE	G	Other	Never Contaminated	Demolish
1926	772-1G	ECOLOGY RESEARCH LABORATORY ANNEX	G	Other	Never Contaminated	Demolish

Table 4.1b*						
EM Integrated Deactivation and Decommissioning Plan (G Area Only)						* Data consistent w/ 2004 PMP
Unit No	Bldg No	Hazard	Facility Area	Status	Current Risk	
		Name			Conceptual Site Model Hazard	Decommissioning Alternative
1930	772-7G	STORAGE BUILDING	G	Other	Never Contaminated	Demolish
1931	772-8G	CORE STORAGE	G	Other	Never Contaminated	Demolish
1932	772-9G	CORE STORAGE	G	Other	Chemical - Low Hazard	Demolish
1962	782-12G	TREAT EXTRACTED GROUNDWATER	G	Other	Other Industrial	Demolish
1963	782-1G	FRP SURGE CONTNMNT OF INJECTION WATER TANK	G	Other	Other Industrial	Demolish
1967	782-2G	FRP SURGE CONTNMNT OF EXTRACTED WATER TANK	G	Other	Chemical - Low Hazard	Demolish
1969	782-4G	TREAT EXTRACTED GROUNDWATER	G	Other	Other Industrial	Demolish
1970	782-7G	FRP SURGE TANK	G	Other	Other Industrial	Demolish
1971	782-8G	FRP INJECTION TANK	G	Other	Other Industrial	Demolish
1995	904-108G	TREMBLER STATION ON C-ROAD	G	Other	Other Industrial	Demolish
1996	904-109G	TREBLER SAMPLER PIT NO. 4	G	Other	Other Industrial	Demolish
1997	904-47G	TREBLER SAMPLER, #1 FOR 904-41G(ABANDON)	G	Other	Other Industrial	Demolish
1998	904-48G	TREBLER SAMPLER, #2 FOR 904-44G(ABANDON)	G	Other	Other Industrial	Demolish

Table 4.2*
ESV Hazard Type Crosswalk for Watershed "TO GO" Units (G Area Only)

* Data consistent w/ 2004 PMP

Facility Area	Waste Unit Group (Hazard Type)										
Watershed	1 Burial Ground Complex	2 Radiological Seepage Basins and Pits	3 Coal Pile Runoff Basins and Ash Basins	4 Inactive Process Sewer Lines	5 Nonradiological Rubble Piles and Pits	6 Nonradiological Seepage Basins	7 Sludge Application Sites	8 Acid/Caustic Basins	9 Miscellaneous Sites	10 Groundwater <i>(Evaluated at Area Hazard)</i>	11 Integrator Operable Units
Fourmile Branch											504
Fourmile Branch											
Fourmile Branch											
Lower Three Runs					39		7		110		505
Lower Three Runs					163						
Lower Three Runs					337						
Lower Three Runs					544						
Pen Branch					61						506
Pen Branch					62						
Pen Branch					63						
Pen Branch					64						
Pen Branch					65						

Facility Area	Waste Unit Group (Hazard Type)										
	1 Burial Ground Complex	2 Radiological Seepage Basins and Pits	3 Coal Pile Runoff Basins and Ash Basins	4 Inactive Process Sewer Lines	5 Nonradiological Rubble Piles and Pits	6 Nonradiological Seepage Basins	7 Sludge Application Sites	8 Acid/Caustic Basins	9 Miscellaneous Sites	10 Groundwater <i>(Evaluated at Area Hazard)</i>	11 Integrator Operable Units
Pen Branch					66						
Pen Branch					67						
Savannah River/Floodplain											508
Steel Creek					546				307		509
Steel Creek											
Steel Creek											
Upper Three Runs		456							208		510

APPENDIX J
AREA CONCEPTUAL SITE MODELS AND HAZARD TABLES

Figures	
Figure 4.7b.1	A-Area CSM for UTR
Figure 4.7b.2	A-Area CSM for SR
Figure 4.8b	B Area CSM <i>for UTR</i>
Figure 4.9b	C Area CSM for FMB
Figure 4.10b	D Area CSM for SR and Floodplain Swamp
Figure 4.11b.1	E Area CSM for FMB
Figure 4.11b.2	E Area CSM for UTR
Figure 4.12b.1	F Area CSM for FMB
Figure 4.12b.2	F Area CSM for UTR
Figure 4.13b.1	H Area CSM for FMB
Figure 4.13b.2	H Area CSM for UTR
Figure 4.14b	K Area CSM for PB
Figure 4.15b.1	L Area CSM for PB
Figure 4.15b.2	L Area CSM for SC
Figure 4.16b.1	M-Area CSM for UTR
Figure 4.16b.2	M-Area CSM for SR
Figure 4.17b.1	N Area CSM for FMB
Figure 4.17b.2	N Area CSM for PB
Figure 4.18b.1	P Area CSM for LTR
Figure 4.18b.2	P Area CSM for SC
Figure 4.19b.1	R Area CSM for LTR
Figure 4.19b.2	R Area CSM for UTR
Figure 4.20b	S Area CSM for UTR
Figure 4.21b	T Area CSM for SR and Floodplain Swamp
Figure 4.22b	Z Area CSM for UTR
Tables	
Table 4.3a	ESV Planned End State by Area
Table 4.3b	EM Integrated Deactivation and Decommissioning Plan
Table 4.4a	ESV Hazard Type Crosswalk for Area "To Go" Units

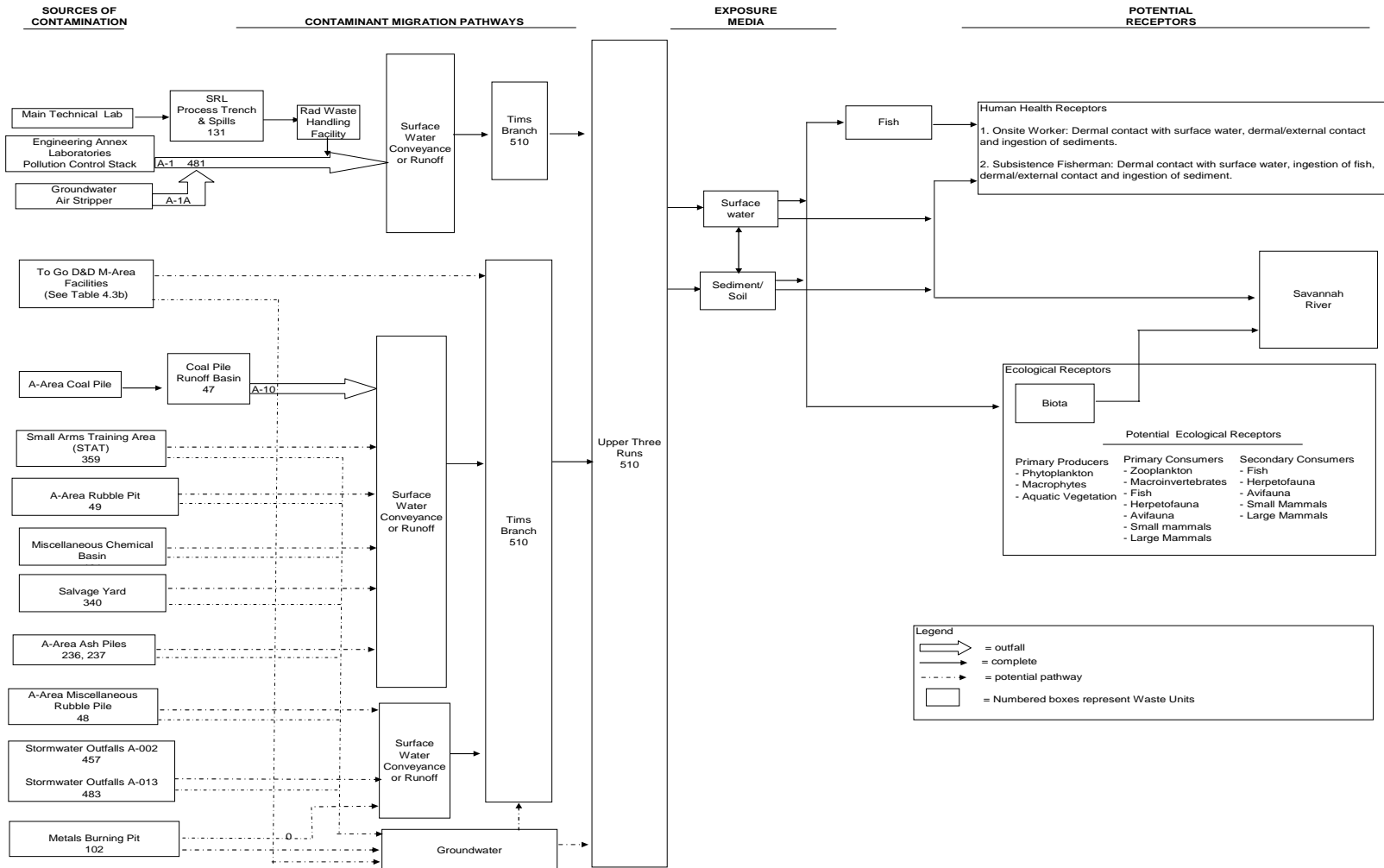

Figure 4.7b.1 A Area CSM for Upper Three Runs

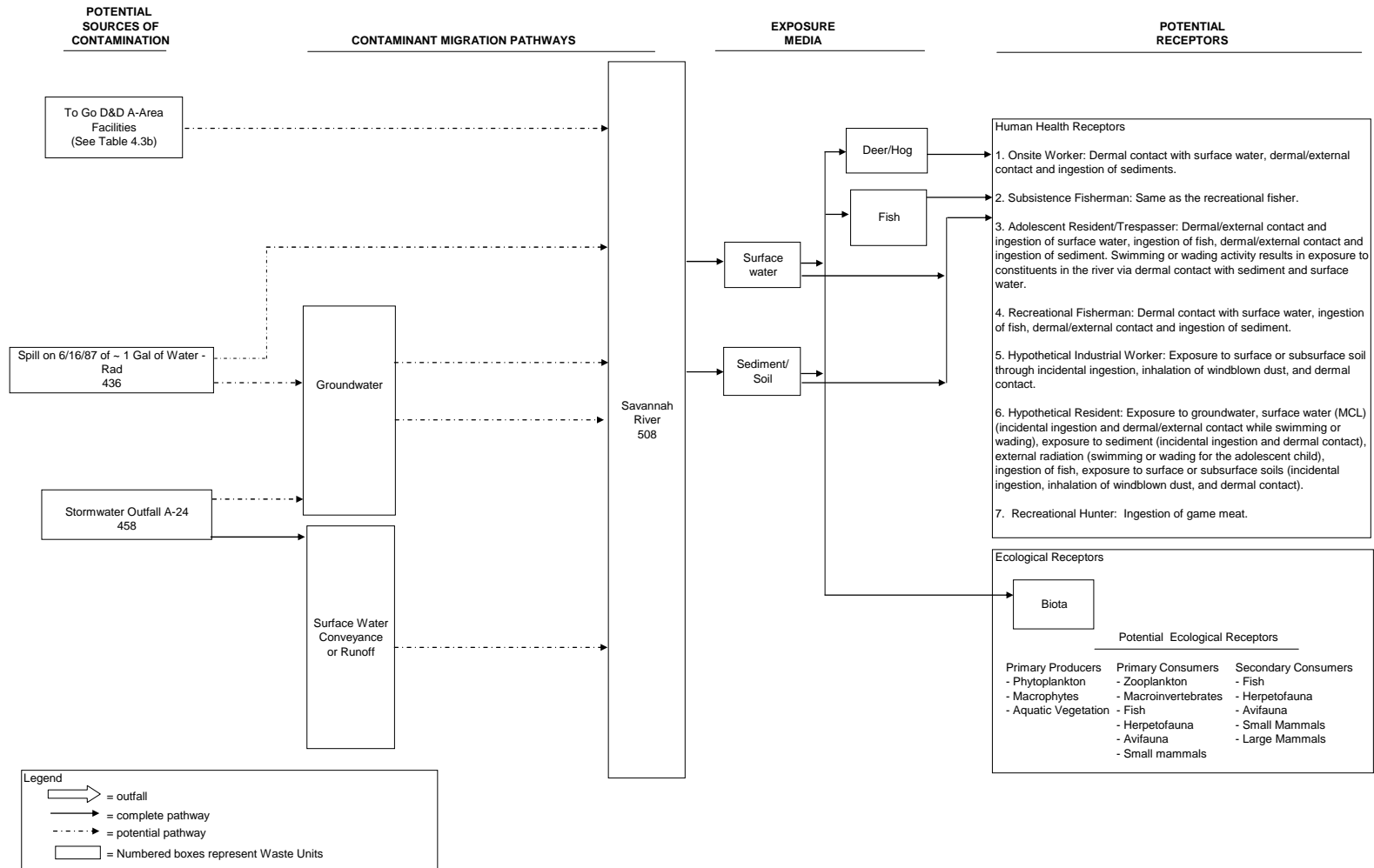

Figure 4.7b.2 A Area CSM for Savannah River and Floodplain Swamp

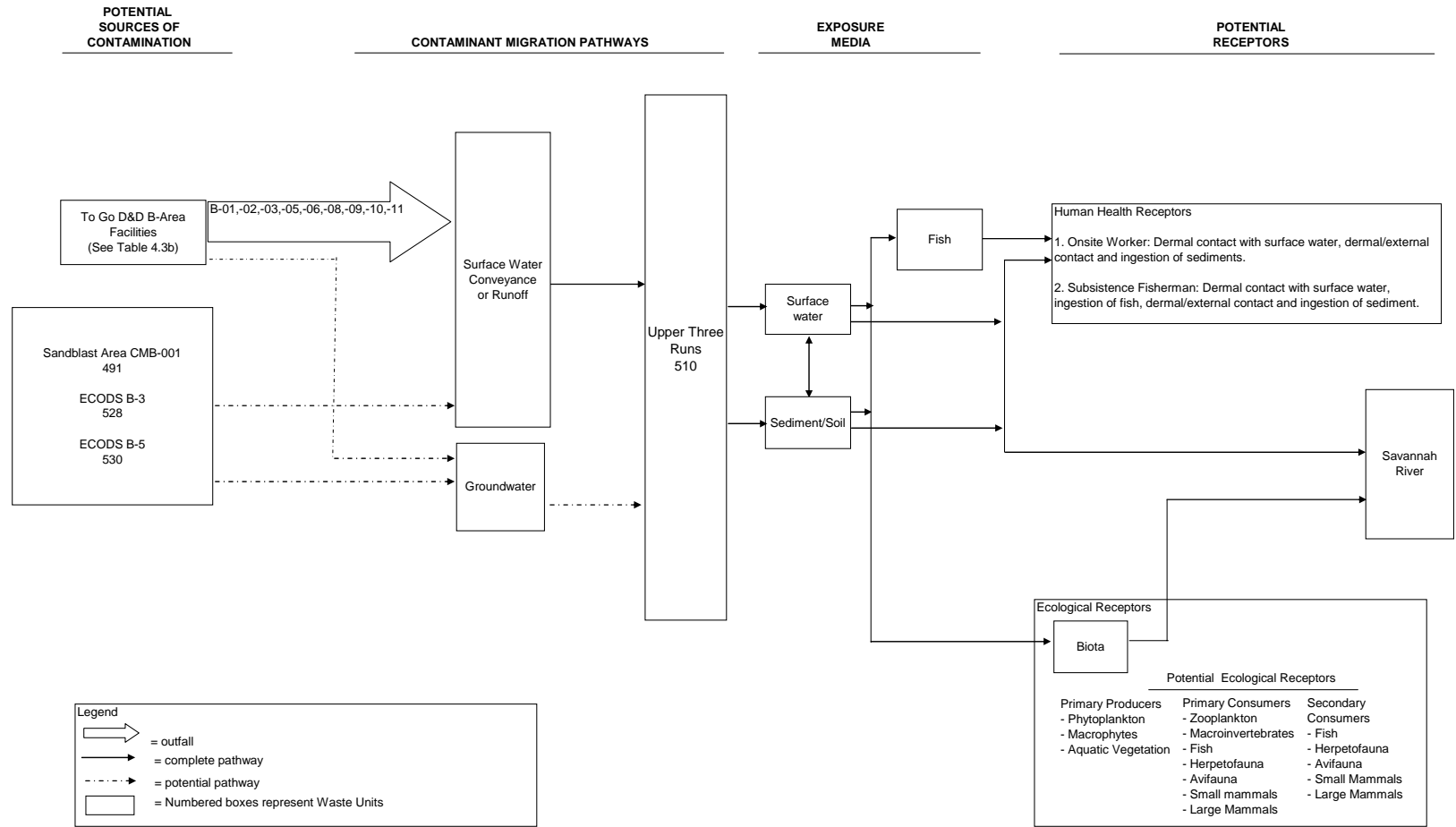

Figure 4.8b B Area CSM for Upper Three Runs

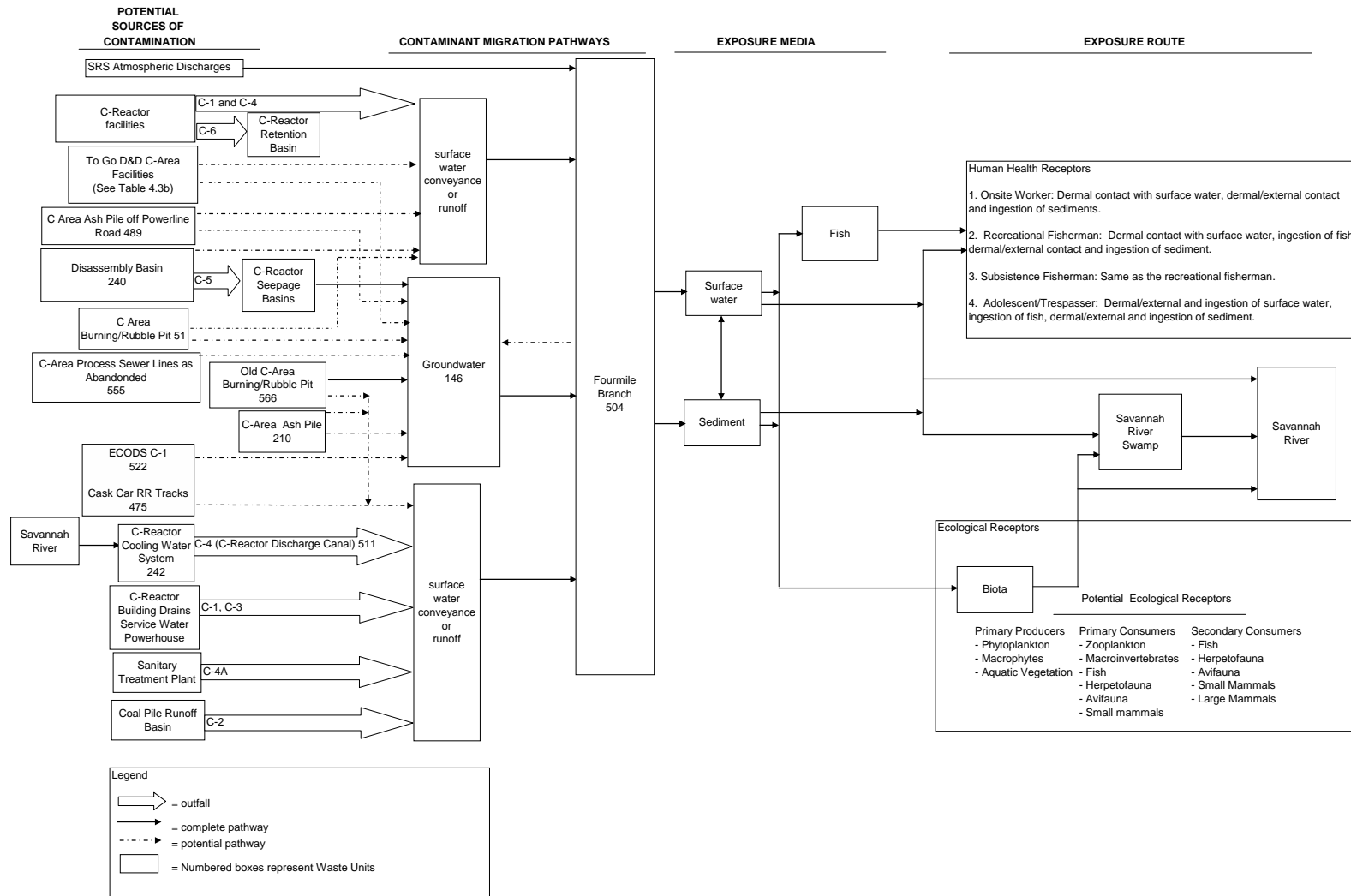

Figure 4.9b C-Area CSM for Fourmile Branch

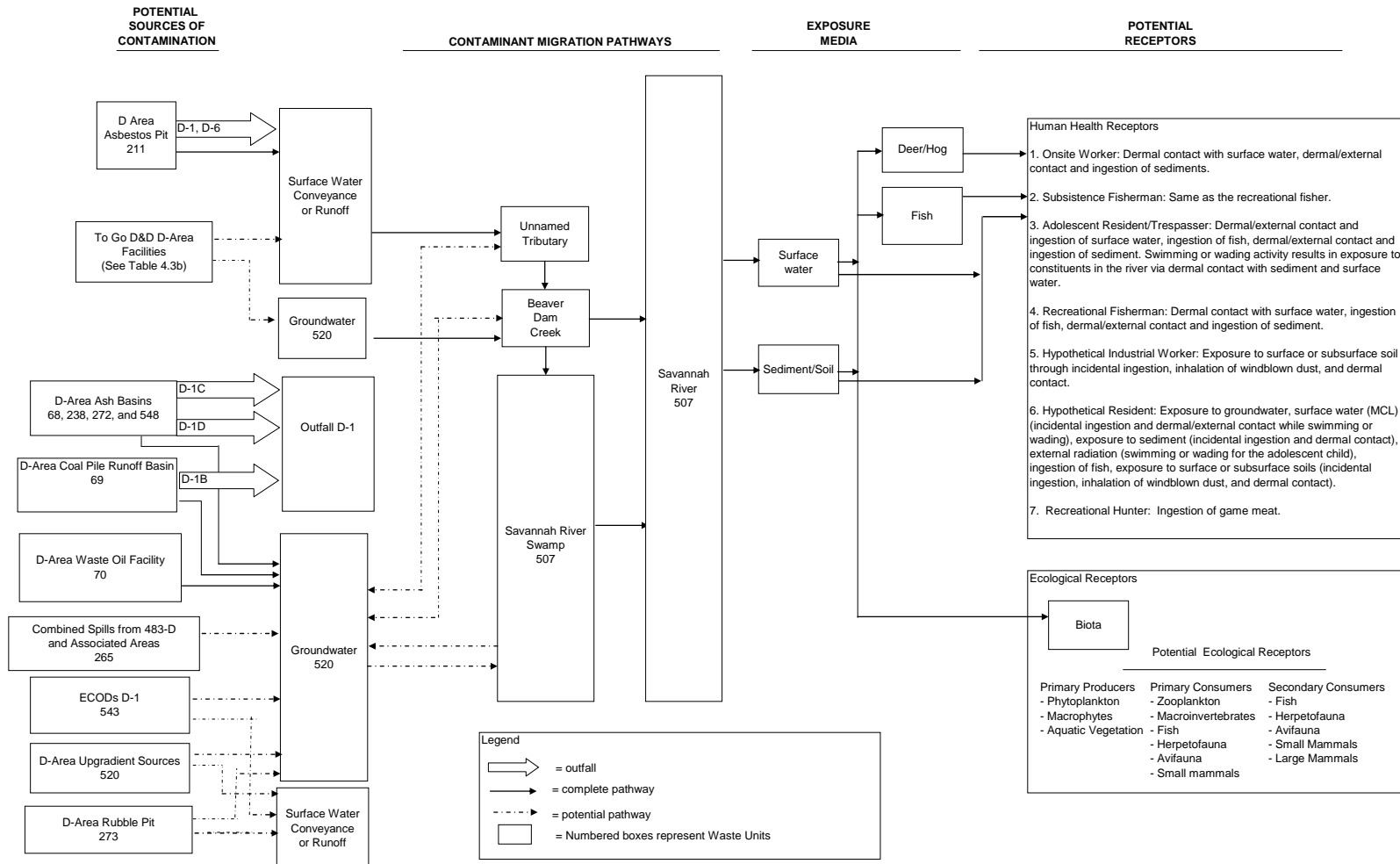

Figure 4.10b D Area CSM for Savannah River and Floodplain Swamp

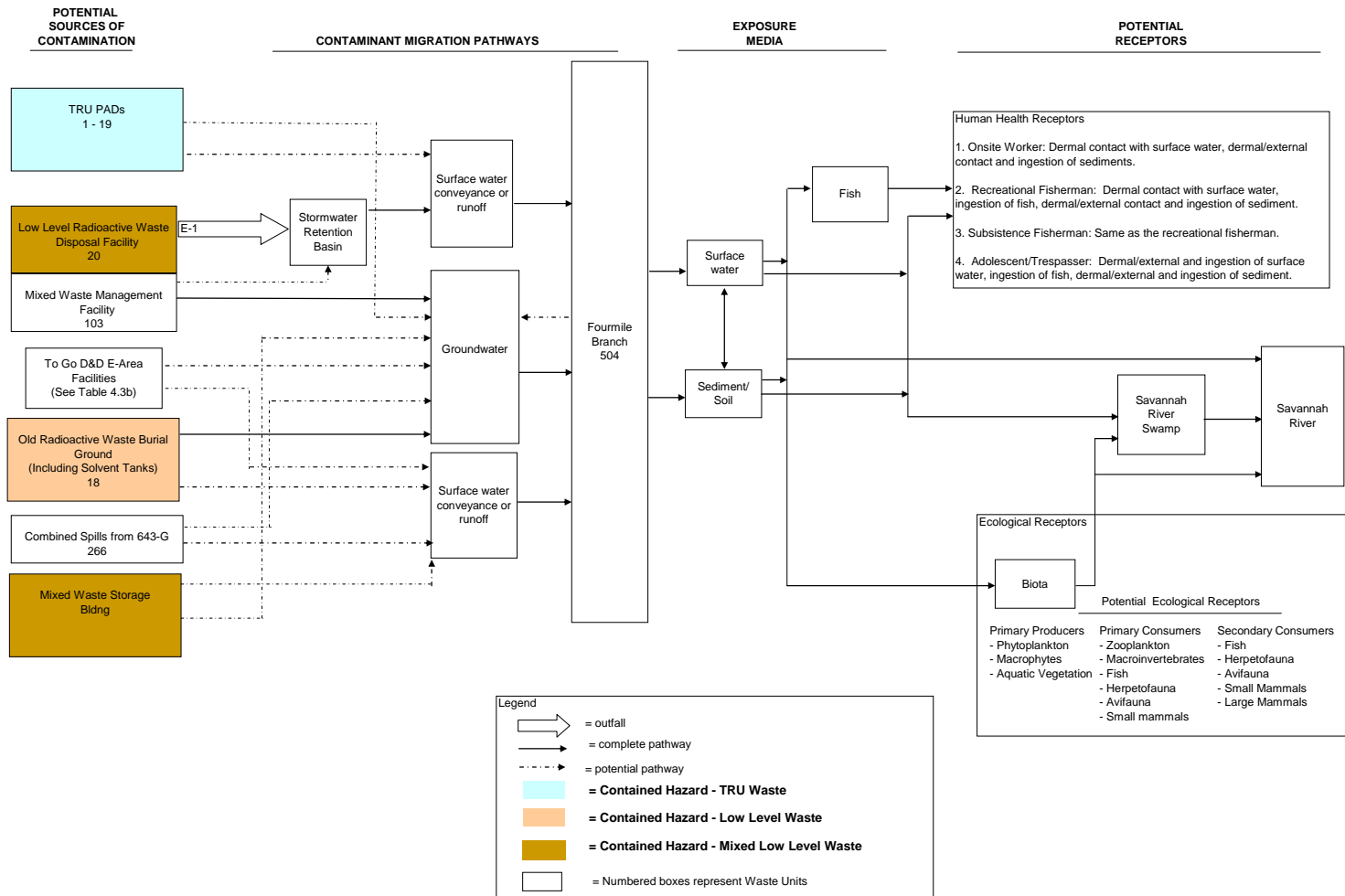

Figure 4.11b.1 E-Area CSM for Fourmile Branch

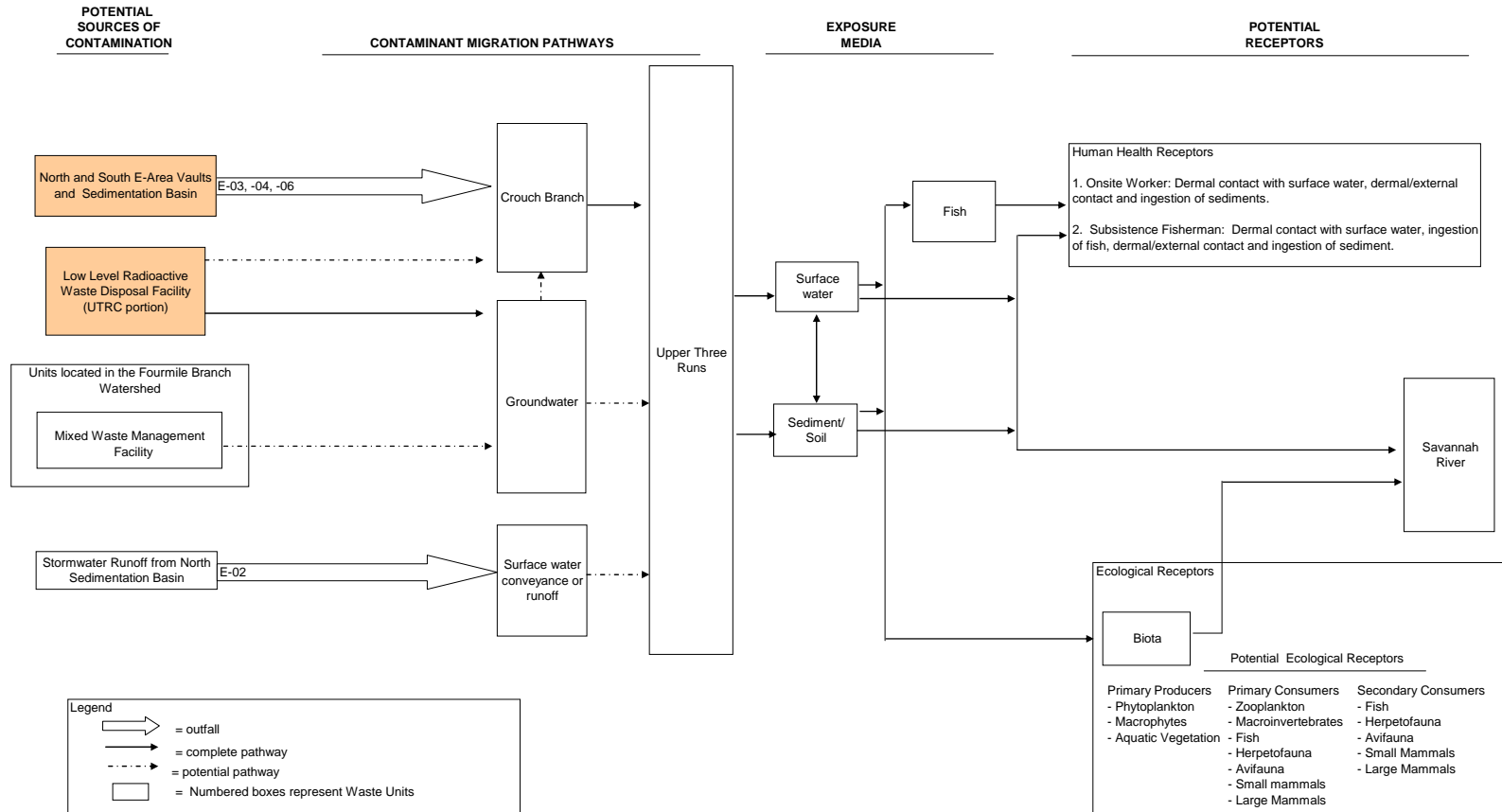

Figure 4.11b.2 E-Area CSM for Upper Three Runs

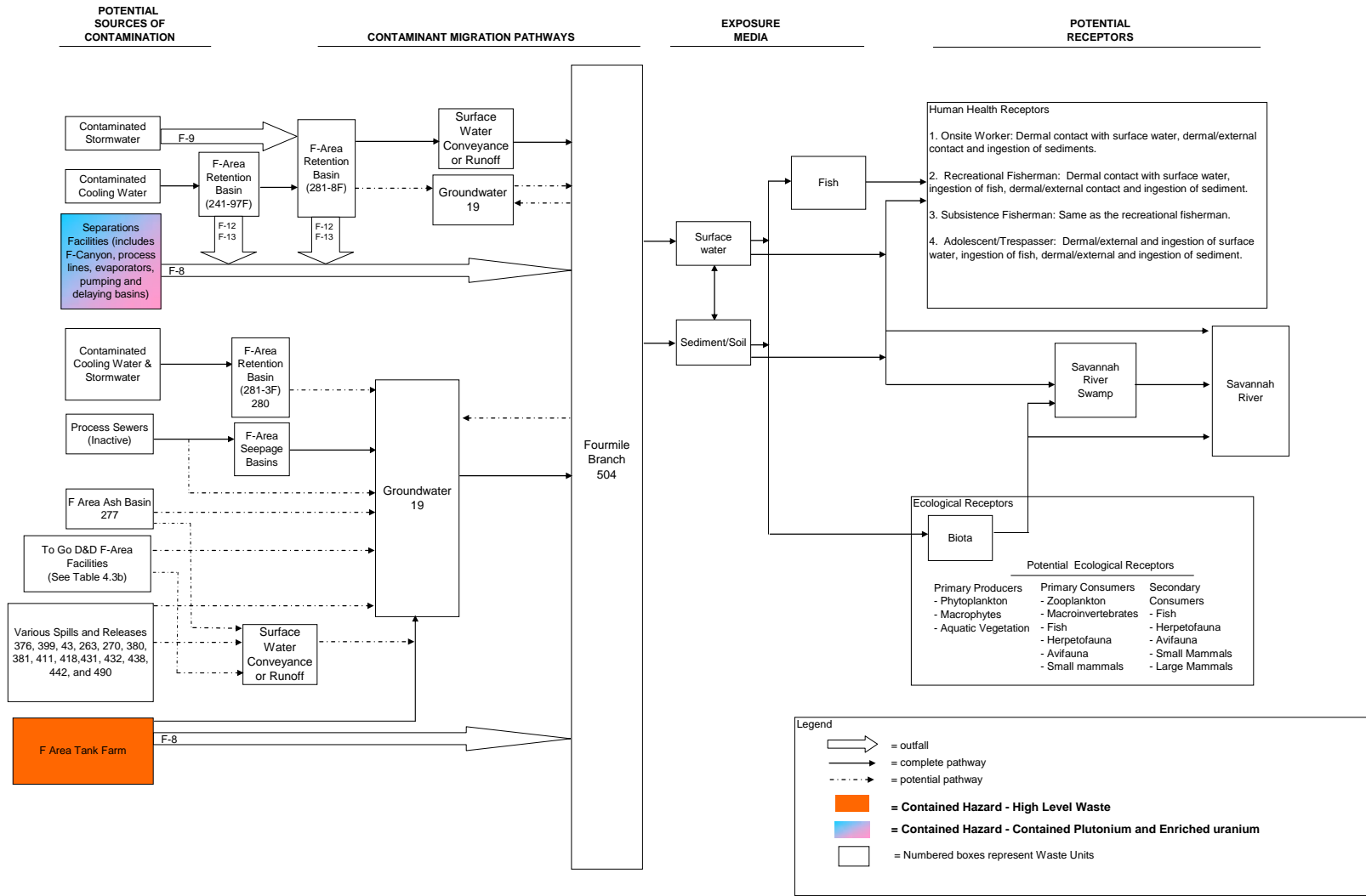

Figure 4.12b.1. F-Area CSM for Fourmile Branch

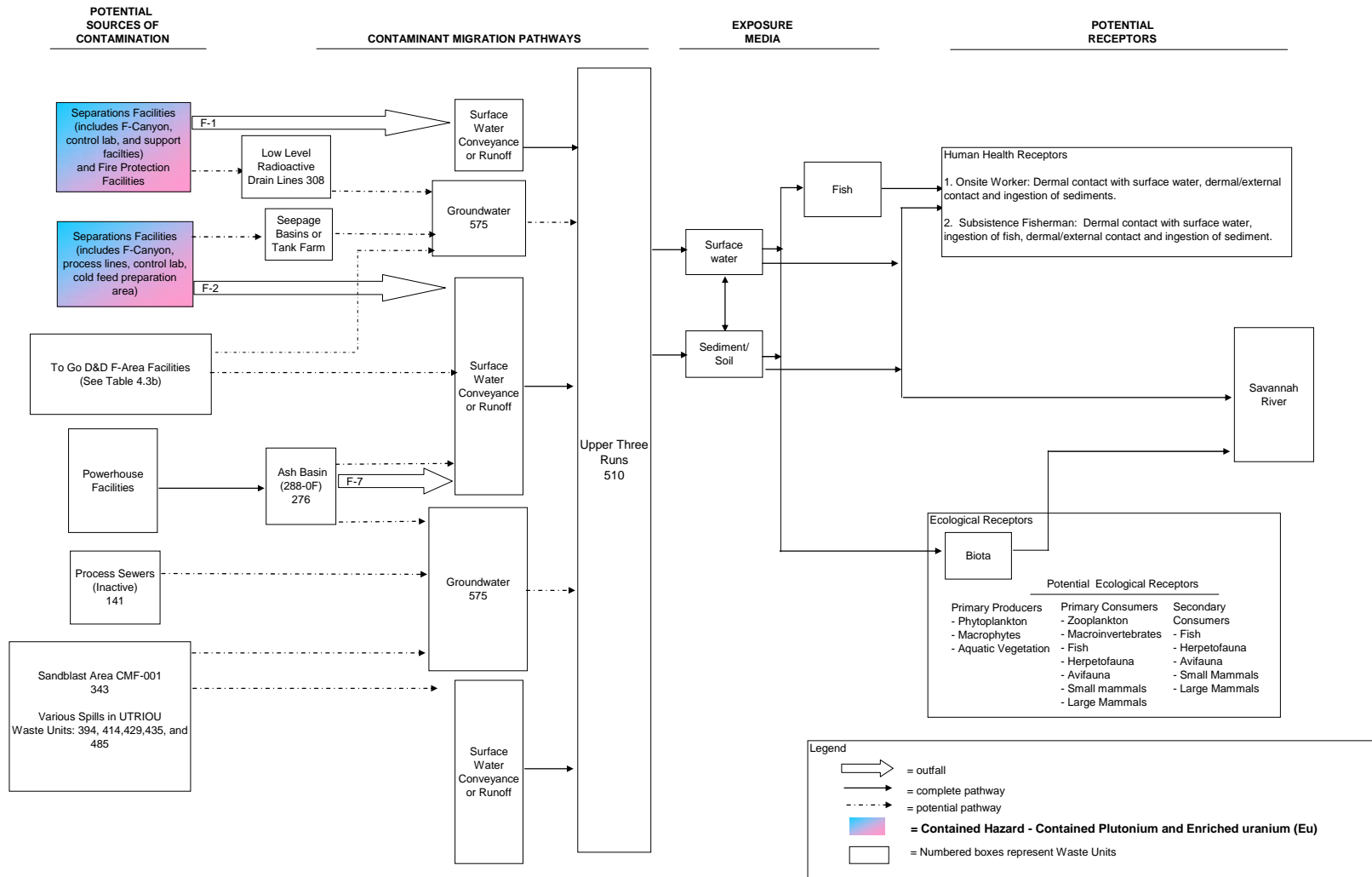

Figure 4.12b.2. F-Area CSM for Upper Three Runs

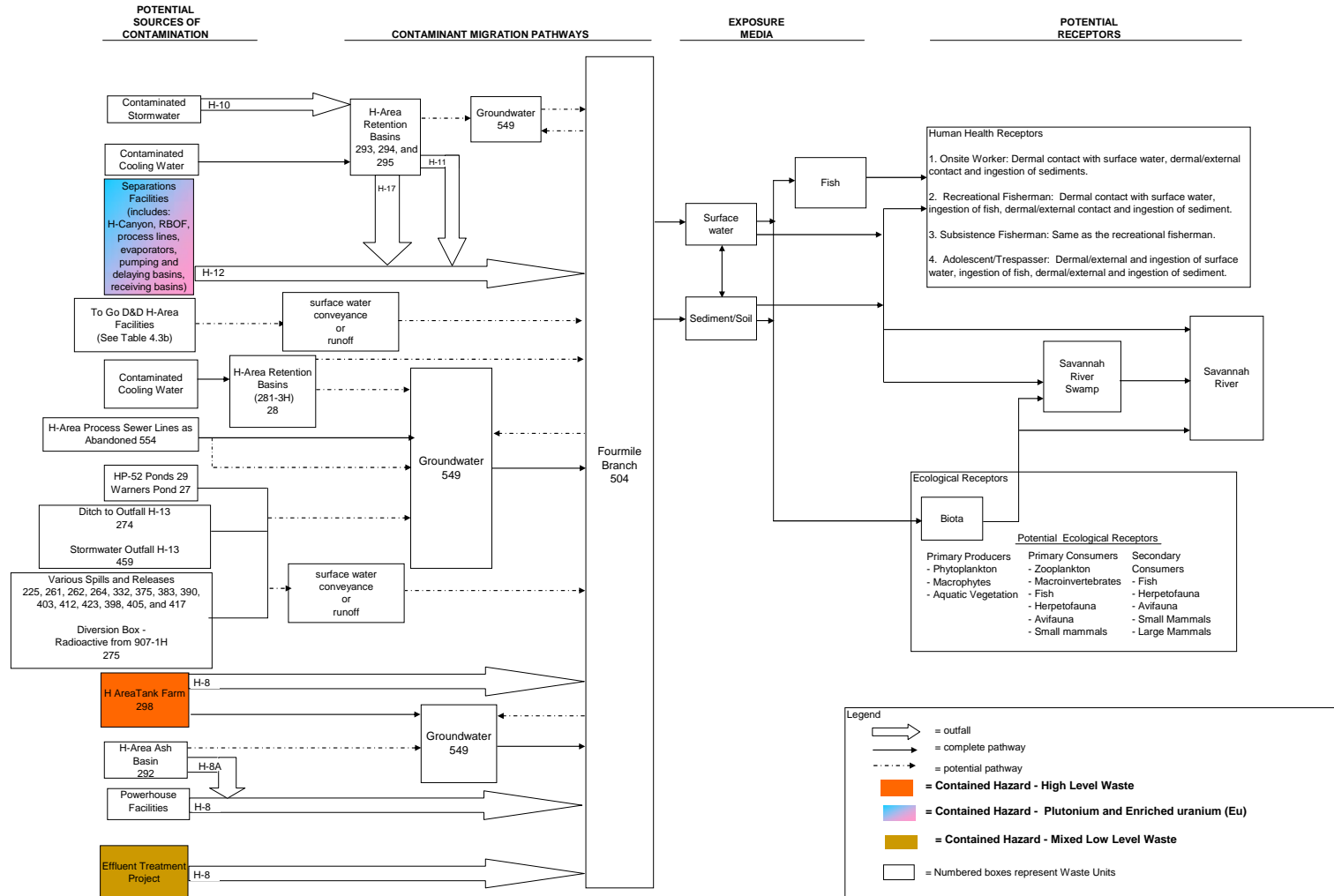

Figure 4.13b.1 H-Area CSM for Fourmile Branch

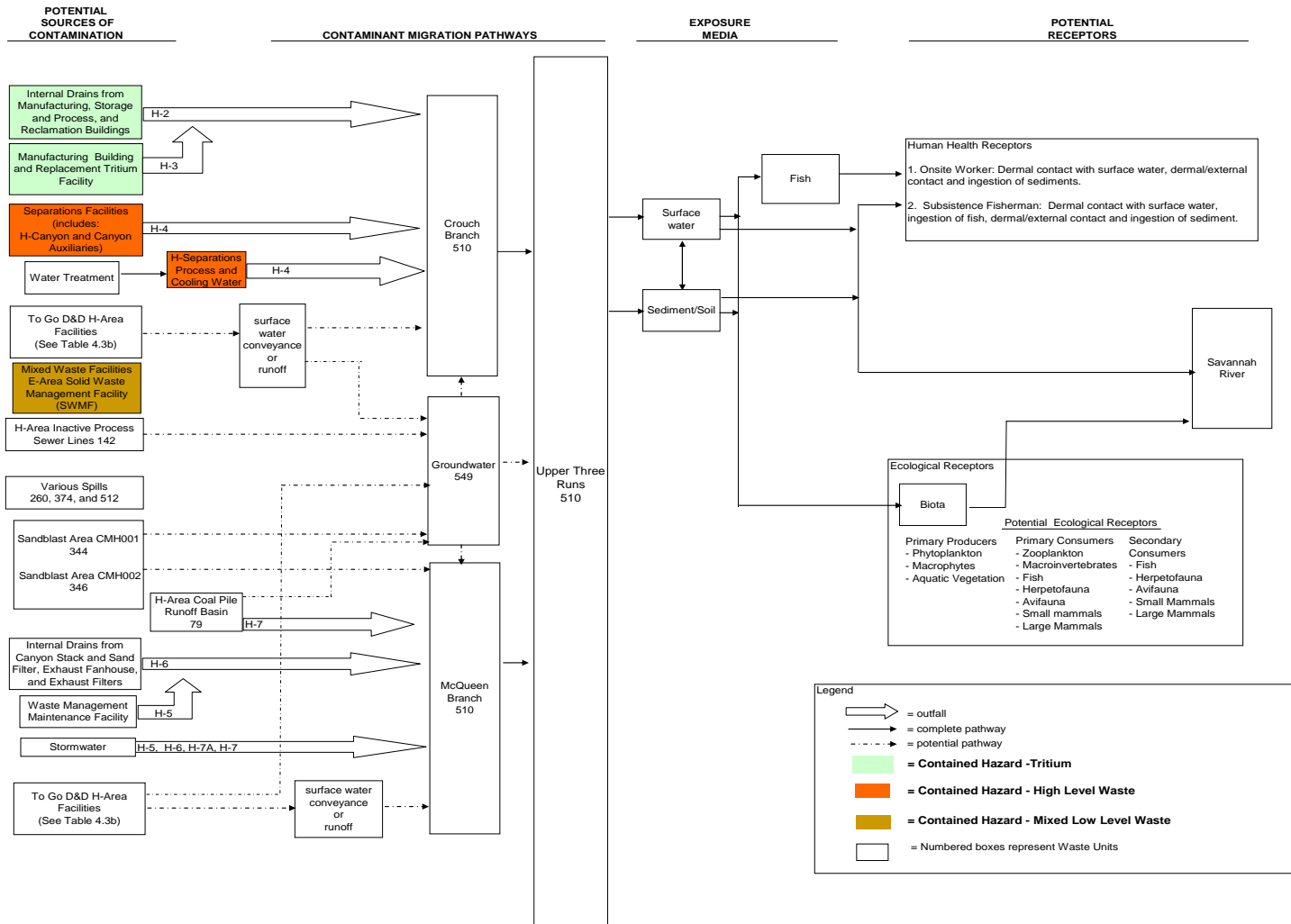

Figure 4.13b.2. H-Area CSM for Upper Three Runs

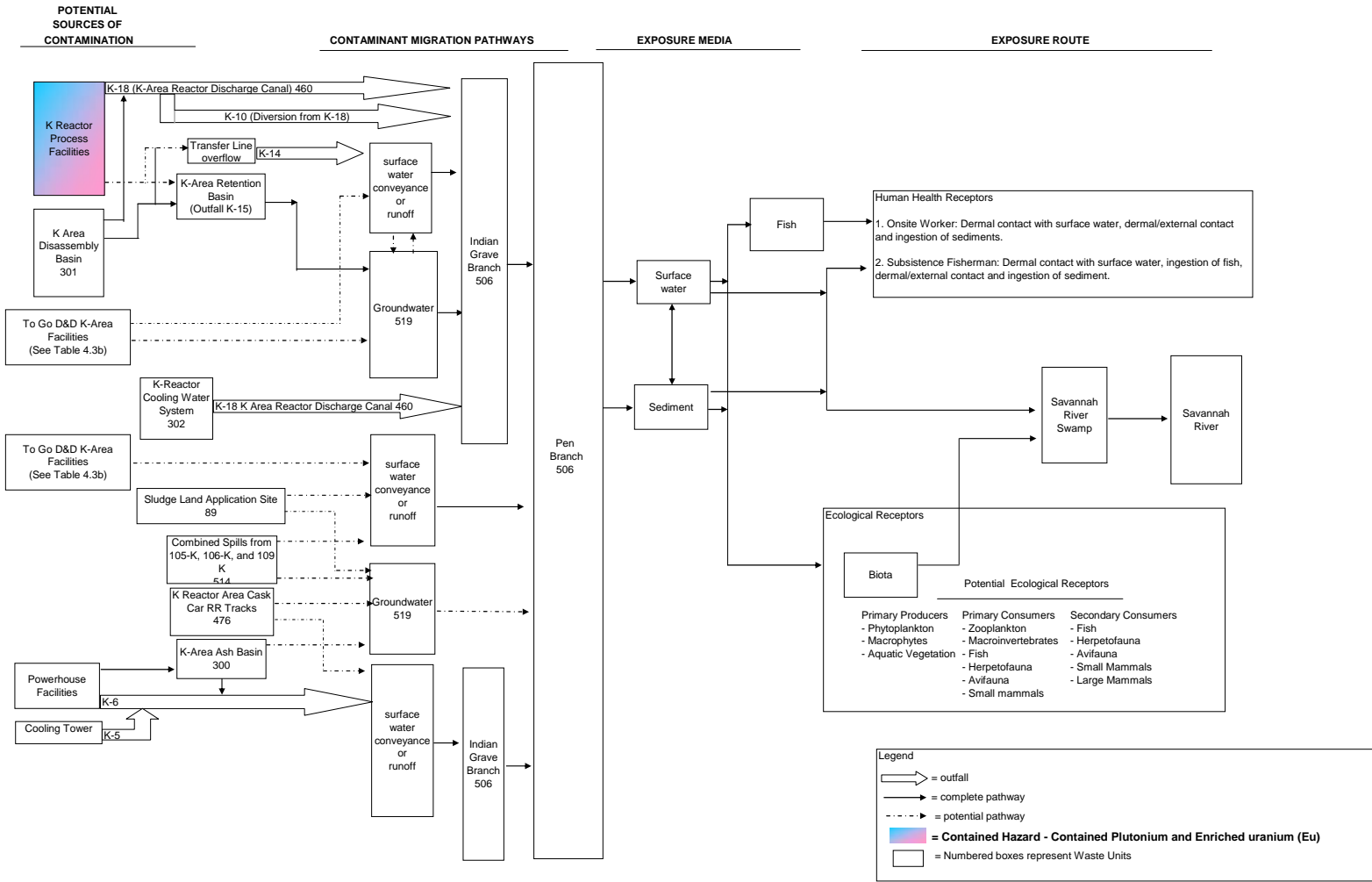

Figure 4.14b K-Area CSM for Pen Branch

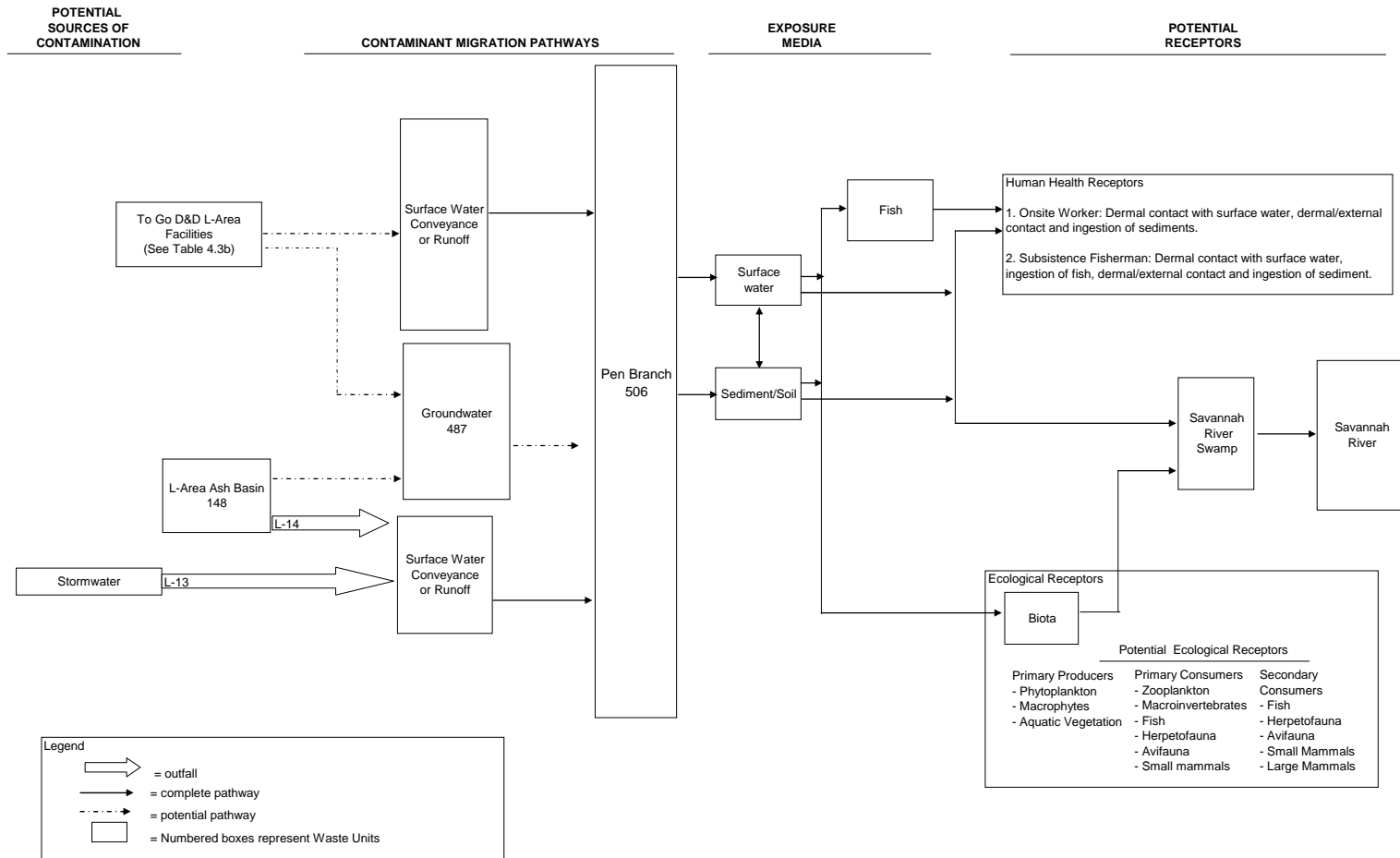

Figure 4.15b.1 L-Area CSM for Pen Branch

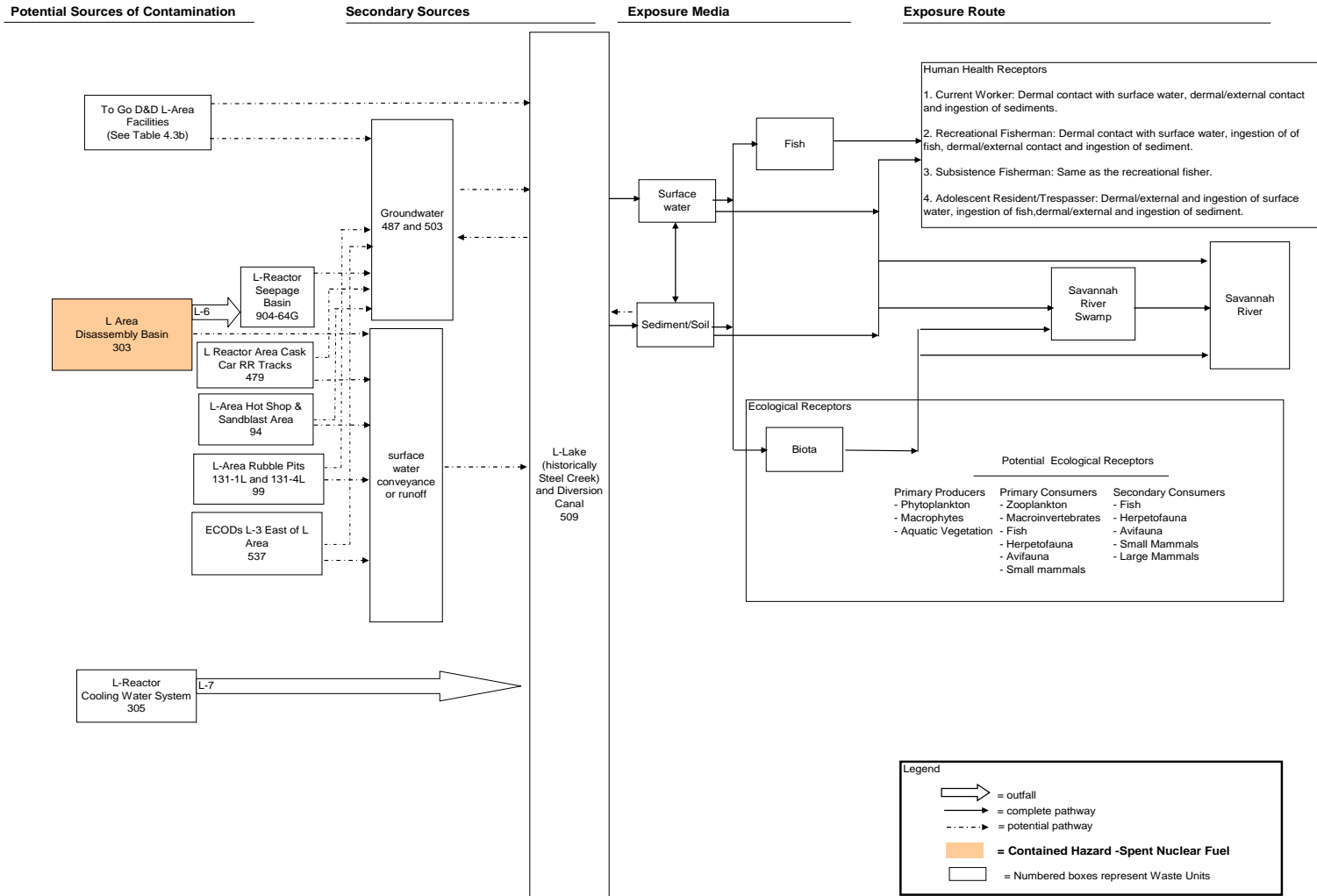

Figure 4.15b.2. L Area CSM for Steel Creek

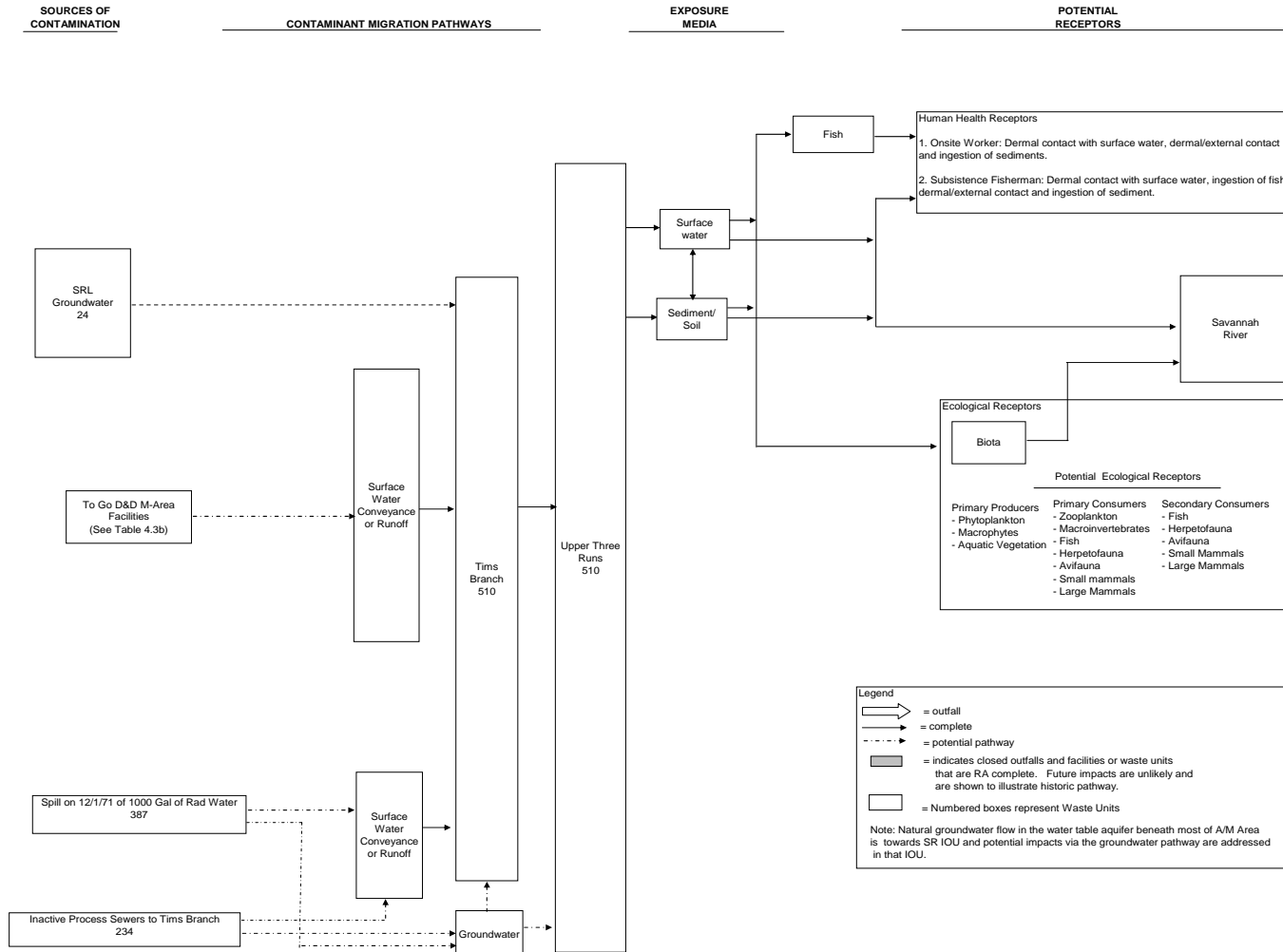

Figure 4.16b.1 M Area CSM for Upper Three Runs

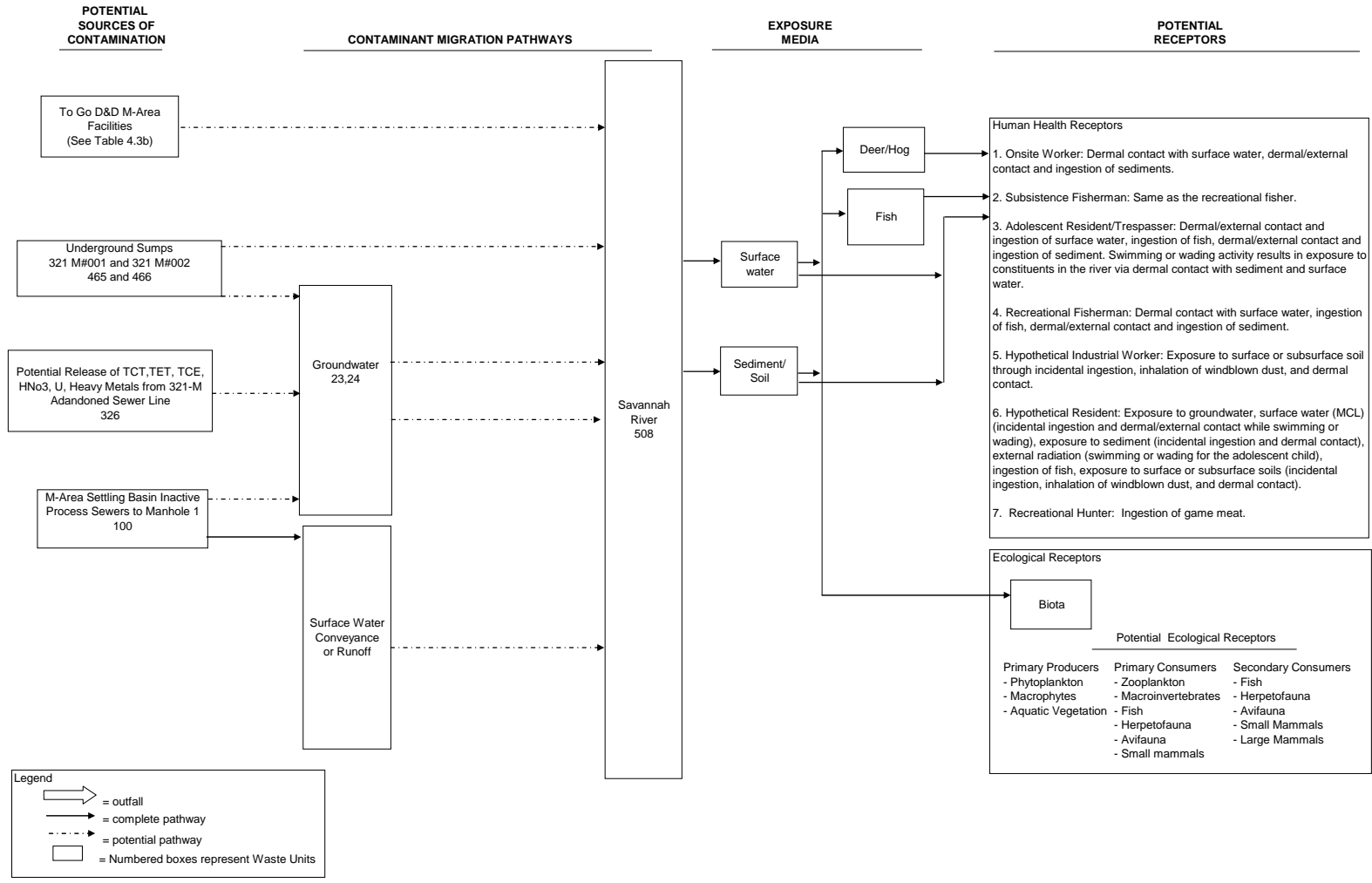

Figure 4.16b.2 M Area CSM for Savannah River and Floodplain Swamp

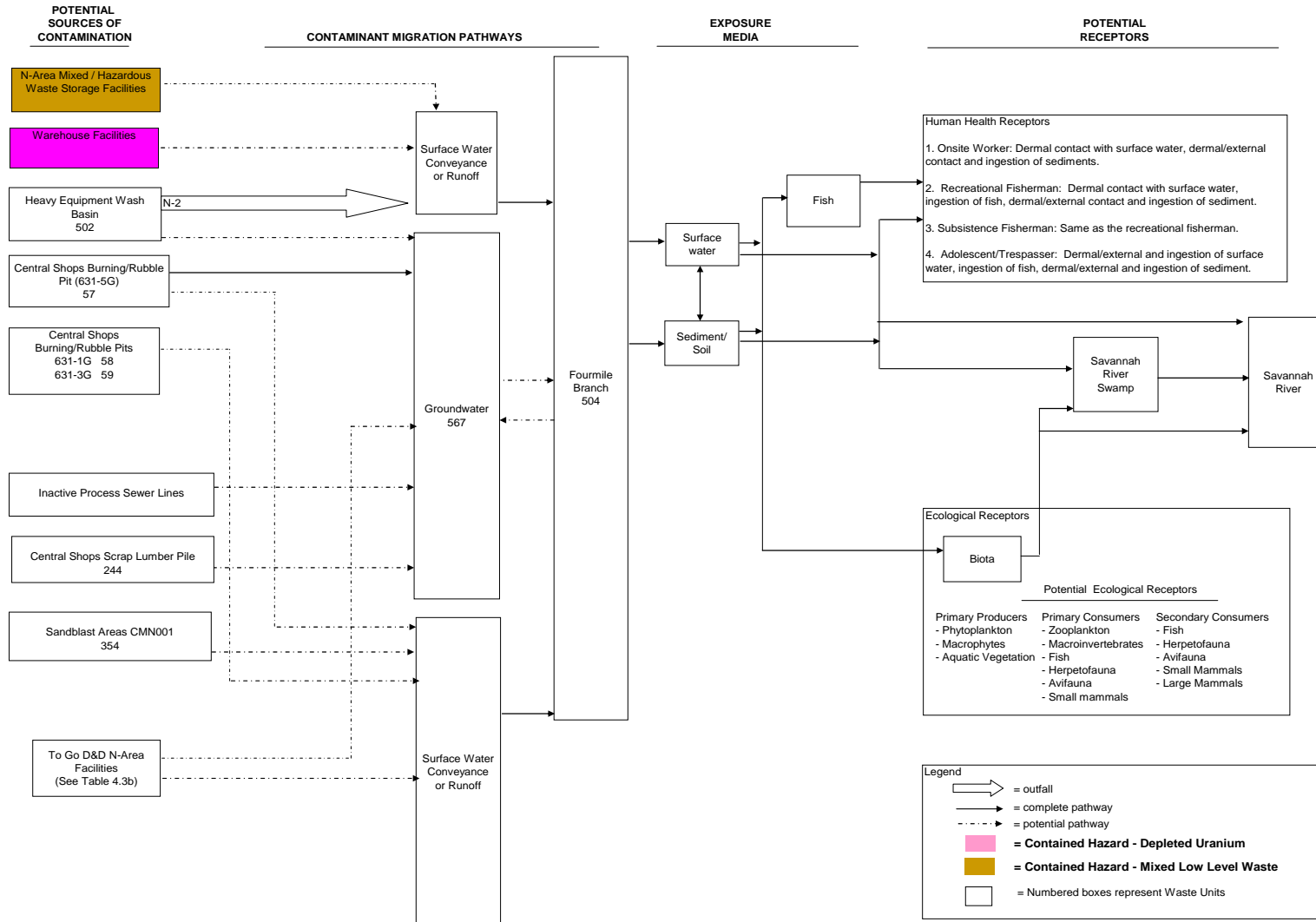

Figure 4.17b.1 N-Area CSM for Fourmile Branch

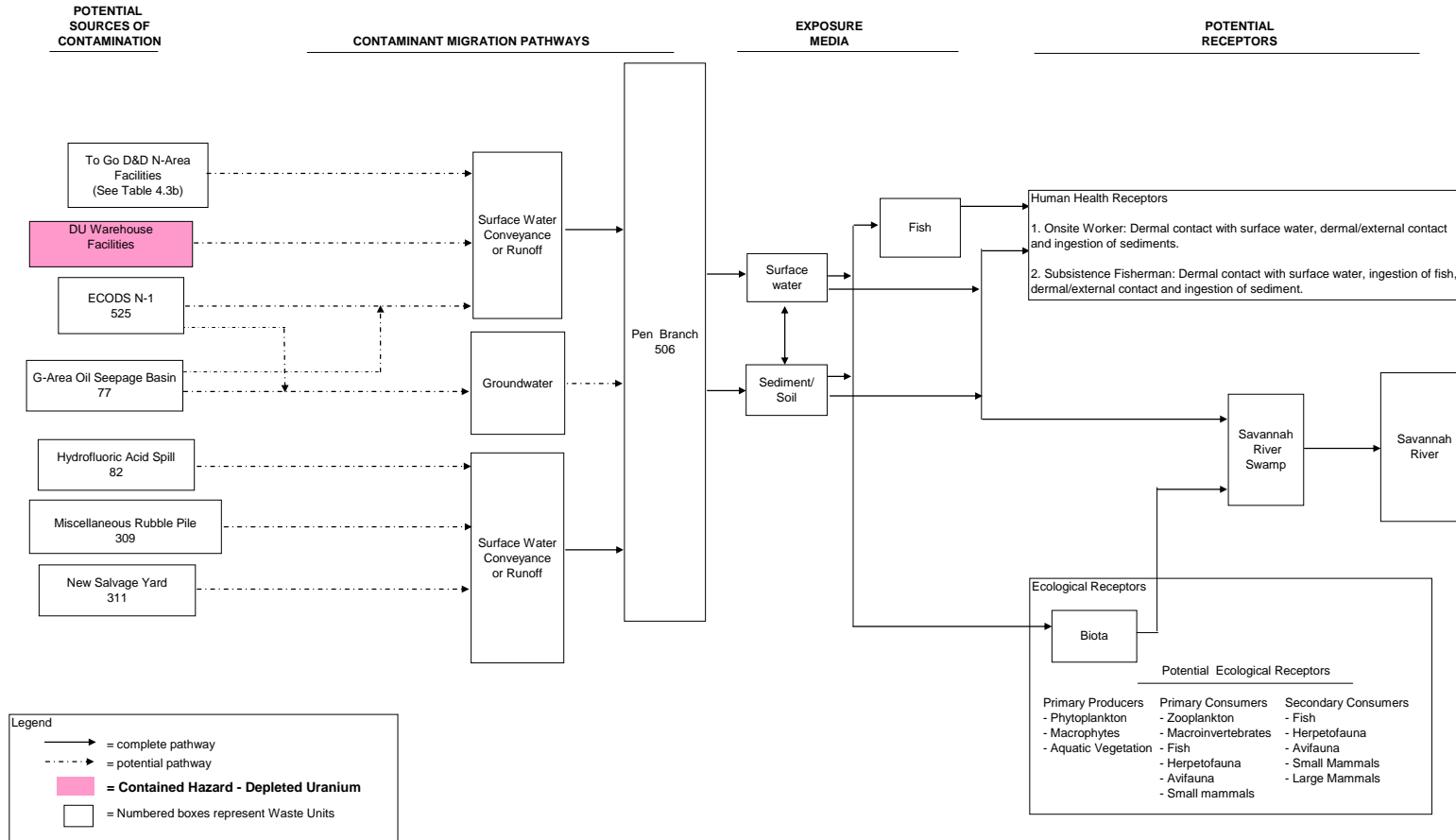

Figure 4.17b.2. N-Area CSM for Pen Branch

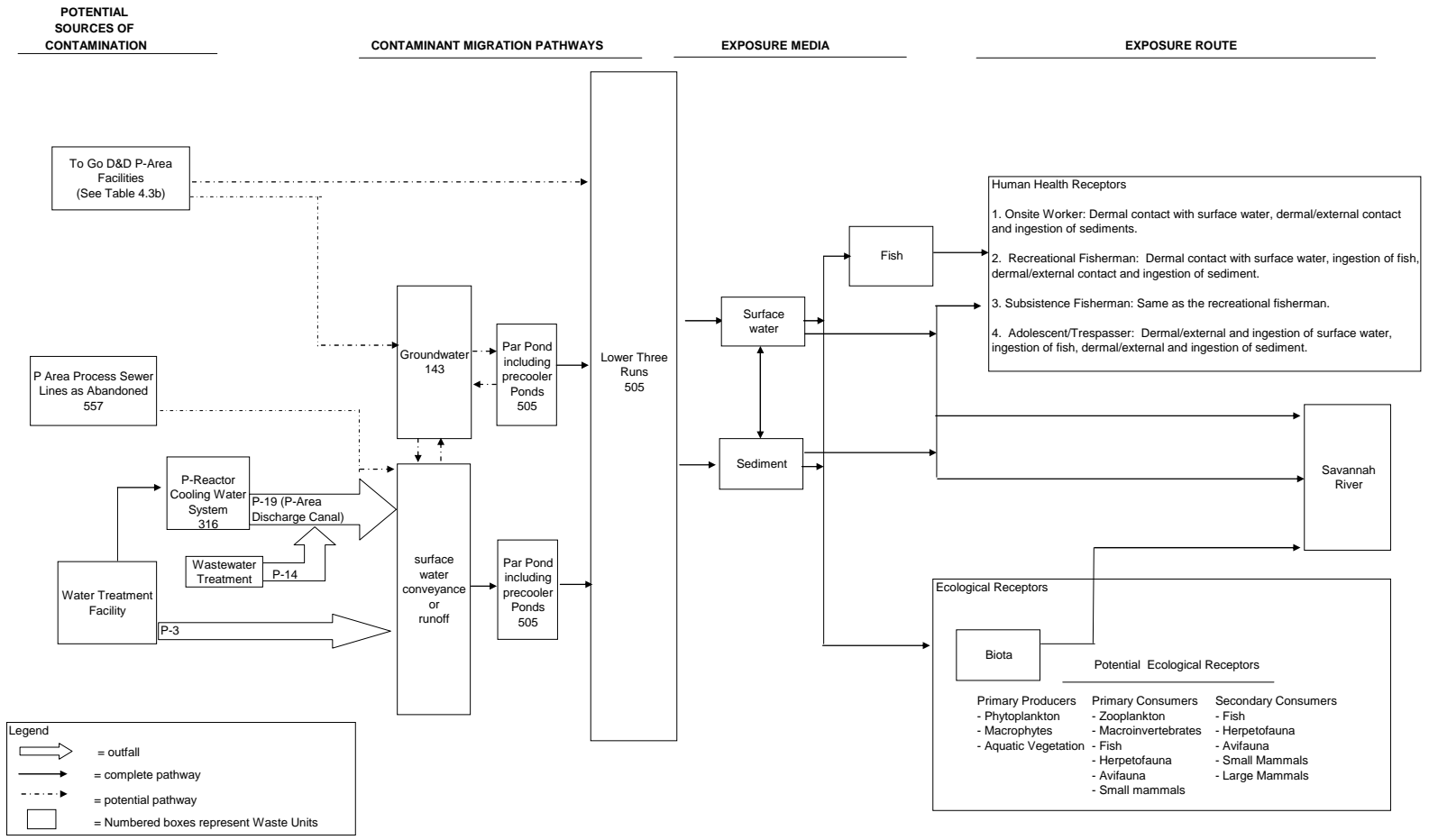

Figure 4.18b.1 P Area CSM for Lower Three Runs

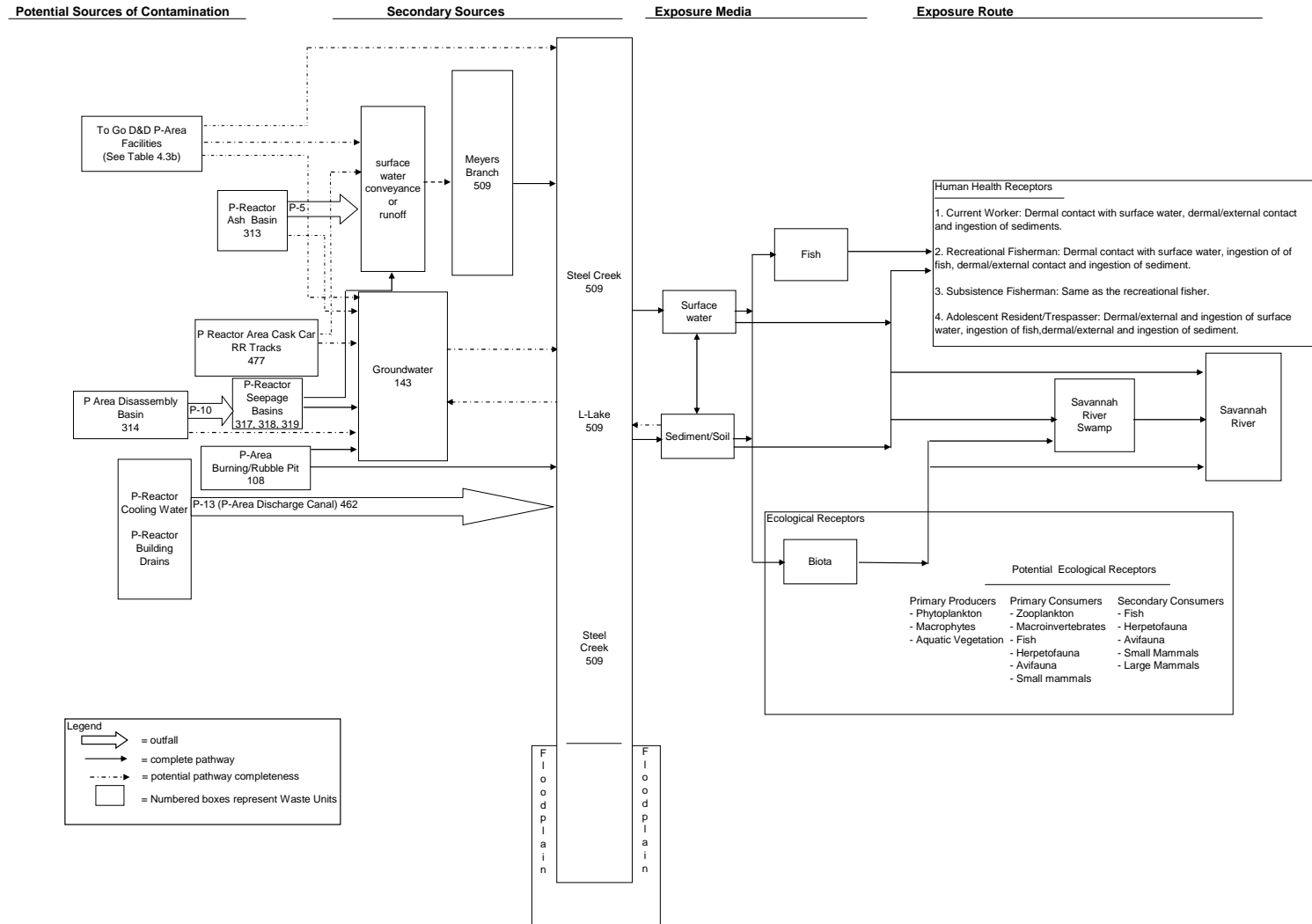

Figure 4.18b.2 P Area CSM for Steel Creek

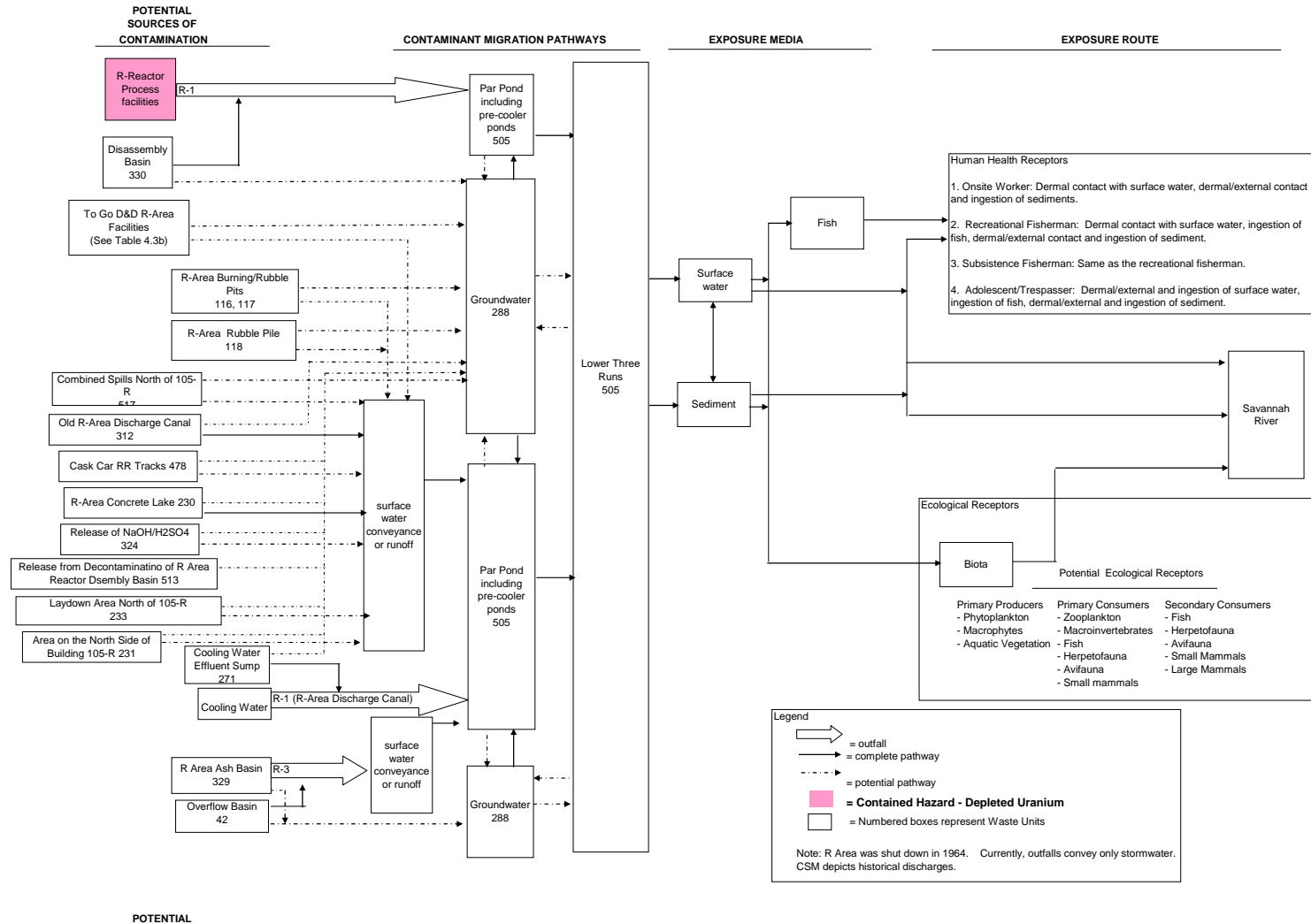

Figure 4.19b.1 R Area CSM for Lower Three Runs

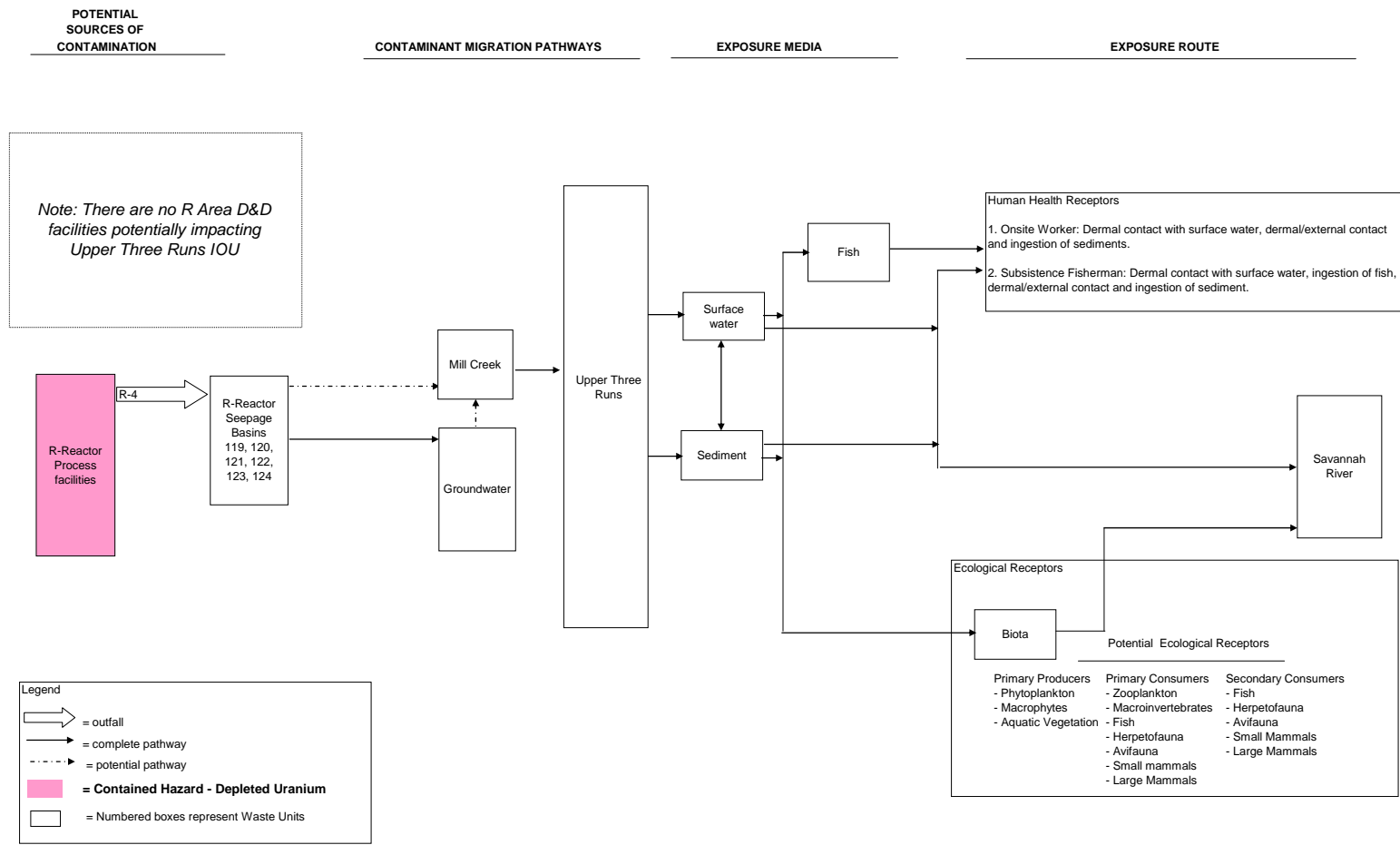

Figure 4.19b.2 R Area CSM for Upper Three Runs

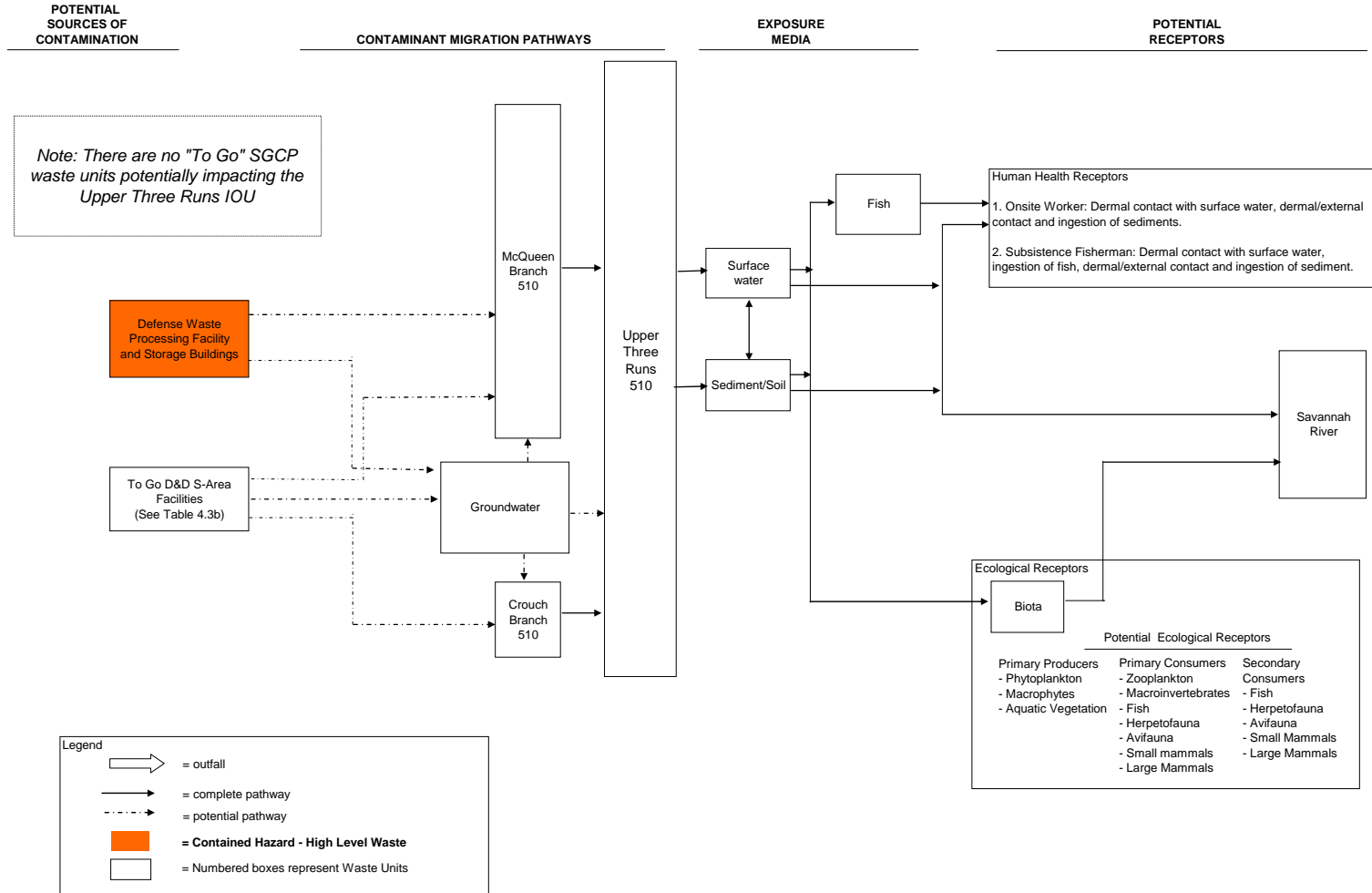

Figure 4.20b S Area CSM for Upper Three Runs

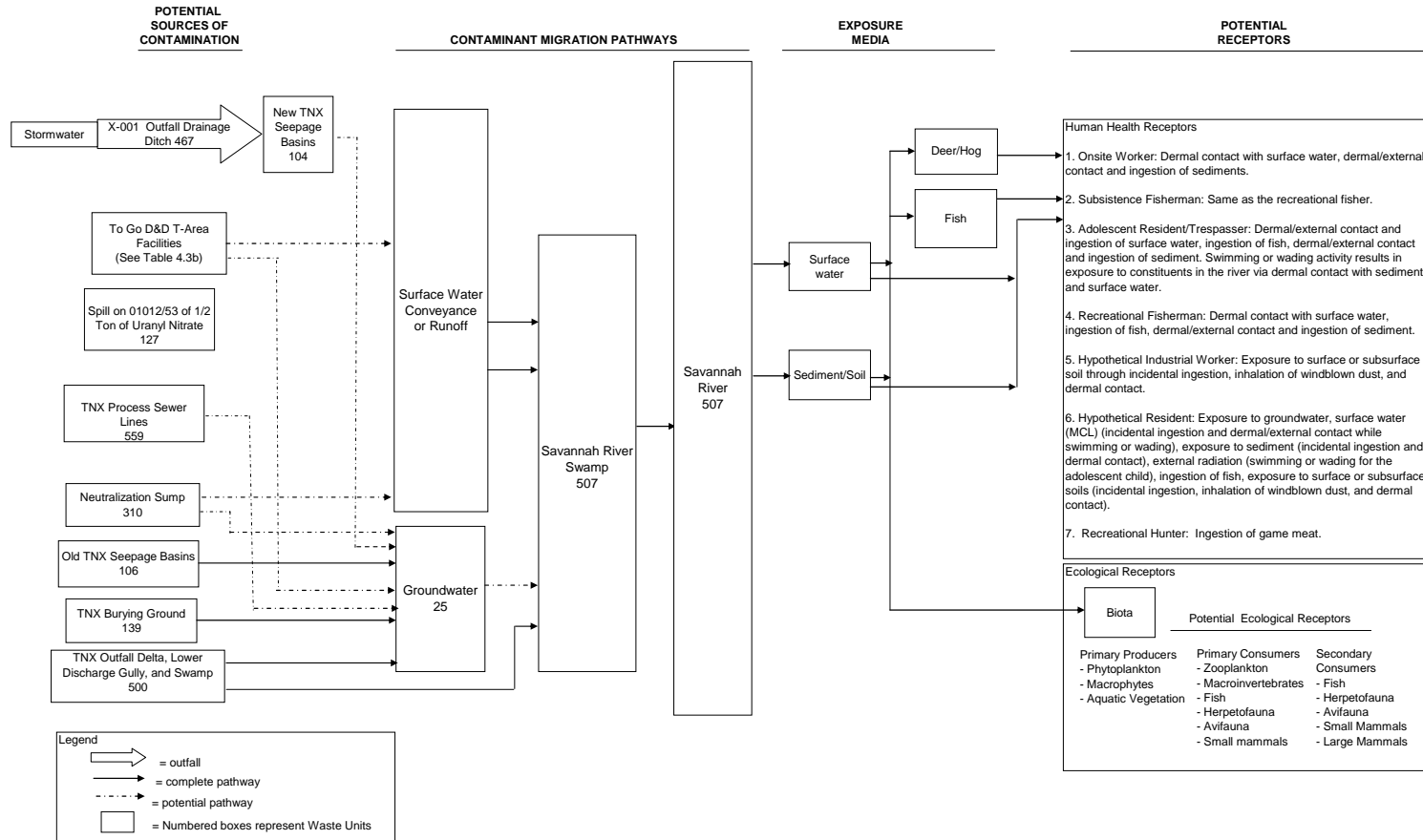

Figure 4.21b T-Area CSM for Savannah River and Floodplain Swamp

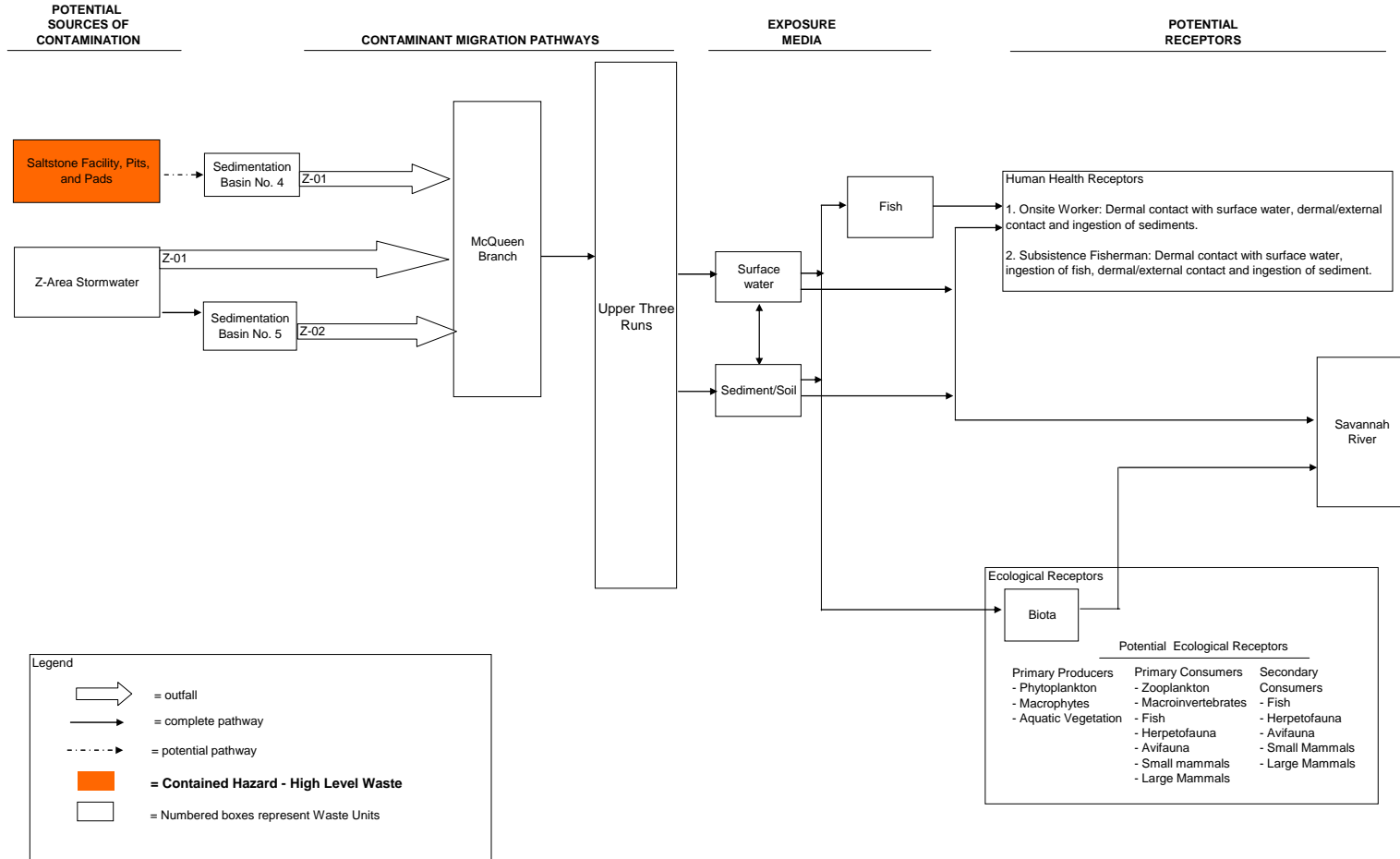

Figure 4.22b Z-Area CSM for Upper Three Runs

Table 4.3a*
RBES Planned End State By Area

*Data Consistantw/2004 PMP

Unit Index #	Unit Name	Watershed	Facility Area	FY03 Estimated Risk	Status	Institutional Controls in Place	Waste Unit Group (Hazard Type)	Soil Remedial Action	Groundwater Remedial Action (NA)
SRS unique identification waste unit number	Unit Name with facility or building number (NBN = no building number).	One of six SRS Watersheds where the unit resides.	Specific SRS geographic area unit resides.	Relative level of risk to a receptor from the unit, with $<10^{-6}$ being the lowest level and $>>10^{-4}$ being the greatest.	Status of unit in the regulatory cleanup process.	Units checked have SRS controls in place to restrict inappropriate uses of land or facilities when contaminants remain at the unit.	One of 11 generic hazard types used to categorize all SRS waste units. (Definitions in Appendix K.)	Remedial action in place for soils media. (Alpha numeric corresponds to actions defined in Appendix K; check mark denotes remedial action as yet to be determined.)	Remedial action in place for groundwater media. (Alpha numeric corresponds to actions defined in Appendix D; check mark denotes remedial action as yet to be determined.)
41	SILVERTON ROAD WASTE SITE, 731-3A	Savannah River / Floodplain / Swamp	A	10 ⁻⁴ to 10 ⁻⁶	Complete	√	5	A.2	B.2
128	SPILL ON 10/13/75 OF 1200 GAL OF PCE, NBN	Savannah River / Floodplain / Swamp	A	< 10 ⁻⁶	Complete		9	A.1	
385	SPILL ON 11/22/85 OF UNKNOWN OF CHROMATED WATER FROM BETWEEN 702-A AND 708-A, NBN	Savannah River / Floodplain / Swamp	A	< 10 ⁻⁶	Complete		9	A.1	
44	716-A MOTOR SHOP SEEPAGE BASIN, 904-101G	Upper Three Runs	A	< 10 ⁻⁶	Complete		6	A.1	
133	SRL SEEPAGE BASINS, 904-53G1	Upper Three Runs	A	10 ⁻⁴ to 10 ⁻⁶	Complete	√	2	A.2, A.3, A.7	
134	SRL SEEPAGE BASINS, 904-53G2	Upper Three Runs	A	10 ⁻⁴ to 10 ⁻⁶	Complete	√	2	A.2, A.3, A.7	
135	SRL SEEPAGE BASINS, 904-54G	Upper Three Runs	A	10 ⁻⁴ to 10 ⁻⁶	Complete	√	2	A.2, A.3, A.7	
136	SRL SEEPAGE BASINS, 904-55G	Upper Three Runs	A	10 ⁻⁴ to 10 ⁻⁶	Complete	√	2	A.2, A.3, A.7	
338	RUBBLE PILE NORTH OF SRL, NBN	Upper Three Runs	A	< 10 ⁻⁶	Complete		5	A.1	

Table 4.3a*
RBES Planned End State By Area

*Data Consistantw/2004 PMP

Unit Index #	Unit Name	Watershed	Facility Area	FY03 Estimated Risk	Status	Institutional Controls in Place	Waste Unit Group (Hazard Type)	Soil Remedial Action	Groundwater Remedial Action (NA)
SRS unique identification waste unit number	Unit Name with facility or building number (NBN = no building number).	One of six SRS Watersheds where the unit resides.	Specific SRS geographic area unit resides.	Relative level of risk to a receptor from the unit, with $<10^{-6}$ being the lowest level and $>>10^{-4}$ being the greatest.	Status of unit in the regulatory cleanup process.	Units checked have SRS controls in place to restrict inappropriate uses of land or facilities when contaminants remain at the unit.	One of 11 generic hazard types used to categorize all SRS waste units. (Definitions in Appendix K.)	Remedial action in place for soils media. (Alpha numeric corresponds to actions defined in Appendix K; check mark denotes remedial action as yet to be determined.)	Remedial action in place for groundwater media. (Alpha numeric corresponds to actions defined in Appendix D; check mark denotes remedial action as yet to be determined.)
361	SPILL OF 218 GRAMS MERCURY ADJACENT TO BLDG. 780-2A, NBN	Upper Three Runs	A	$< 10^{-6}$	Complete		9	A.1	
384	SPILL ON 11/21/87 OF 170 GAL OF KOH, SMBS, NAPO4 FROM 784-A, NBN	Upper Three Runs	A	$< 10^{-6}$	Complete		9	A.1	
419	SPILL ON 05/01/85 OF 1 GAL OF ALCOHOL FROM 779-A, NBN	Upper Three Runs	A	$< 10^{-6}$	Complete		9	A.1	
449	SPILL ON 09/01/85 OF <1 LB OF MERCURY FROM 748-A, NBN	Upper Three Runs	A	$< 10^{-6}$	Complete		9	A.1	
521	ECODS A-2 (NEAR SANDBLAST AREA CMM-001, NBN)	Upper Three Runs	A	$< 10^{-6}$	Complete		5	A.1	
436	SPILL ON 06/16/87 OF ~ 1 GAL OF WATER - RAD, NBN	Savannah River / Floodplain / Swamp	A	10^{-4} to 10^{-6}	In Assessment Phase		9	√	
458	STORMWATER OUTFALL A-024, NBN	Savannah River / Floodplain / Swamp	A	10^{-4} to 10^{-6}	In Assessment Phase		9	√	
47	A-AREA COAL PILE RUNOFF BASIN, 788-3A	Upper Three Runs	A	10^{-4} to 10^{-6}	In Assessment Phase		3	√	
131	SRL 904-A PROCESS TRENCH, 904-A	Upper Three Runs	A	$> 10^{-4}$	In Assessment Phase		9	√	

Table 4.3a*
RBES Planned End State By Area

*Data Consistantw/2004 PMP

Unit Index #	Unit Name	Watershed	Facility Area	FY03 Estimated Risk	Status	Institutional Controls in Place	Waste Unit Group (Hazard Type)	Soil Remedial Action	Groundwater Remedial Action (NA)
SRS unique identification waste unit number	Unit Name with facility or building number (NBN = no building number).	One of six SRS Watersheds where the unit resides.	Specific SRS geographic area unit resides.	Relative level of risk to a receptor from the unit, with $<10^{-6}$ being the lowest level and $>>10^{-4}$ being the greatest.	Status of unit in the regulatory cleanup process.	Units checked have SRS controls in place to restrict inappropriate uses of land or facilities when contaminants remain at the unit.	One of 11 generic hazard types used to categorize all SRS waste units. (Definitions in Appendix K.)	Remedial action in place for soils media. (Alpha numeric corresponds to actions defined in Appendix K; check mark denotes remedial action as yet to be determined.)	Remedial action in place for groundwater media. (Alpha numeric corresponds to actions defined in Appendix D; check mark denotes remedial action as yet to be determined.)
236	A-AREA ASH PILE, 788-0A	Upper Three Runs	A	10-4 to 10-6	In Assessment Phase		3	√	
237	A-AREA ASH PILE, 788-2A	Upper Three Runs	A	10-4 to 10-6	In Assessment Phase		3	√	
340	SALVAGE YARD, 740-A	Upper Three Runs	A	10-4 to 10-6	In Assessment Phase		5	√	
359	SMALL ARMS TRAINING AREA (SATA), NBN	Upper Three Runs	A	10-4 to 10-6	In Assessment Phase		9	√	
457	STORMWATER OUTFALL A-002, NBN	Upper Three Runs	A	10-4 to 10-6	In Assessment Phase		9	√	
481	A-001 OUTFALL, NBN	Upper Three Runs	A	> 10-4	In Assessment Phase		9	√	
483	STORMWATER OUTFALL A-013, NBN	Upper Three Runs	A	10-4 to 10-6	In Assessment Phase		9	√	
45	A-AREA BURNING/RUBBLE PITS, 731-1A	Upper Three Runs	A	10-4 to 10-6	In Remediation	√	5	A.2, A.3	B.2, B.4, B.5
46	A-AREA BURNING/RUBBLE PITS, 731-A	Upper Three Runs	A	10-4 to 10-6	In Remediation	√	5	A.2, A.3	B.2, B.4, B.5
48	A-AREA MISCELLANEOUS RUBBLE PILE, 731-6A	Upper Three Runs	A	> 10-4	In Remediation		5	√	√

Table 4.3a*
RBES Planned End State By Area

*Data Consistantw/2004 PMP

Unit Index #	Unit Name	Watershed	Facility Area	FY03 Estimated Risk	Status	Institutional Controls in Place	Waste Unit Group (Hazard Type)	Soil Remedial Action	Groundwater Remedial Action (NA)
SRS unique identification waste unit number	Unit Name with facility or building number (NBN = no building number).	One of six SRS Watersheds where the unit resides.	Specific SRS geographic area unit resides.	Relative level of risk to a receptor from the unit, with $<10^{-6}$ being the lowest level and $>>10^{-4}$ being the greatest.	Status of unit in the regulatory cleanup process.	Units checked have SRS controls in place to restrict inappropriate uses of land or facilities when contaminants remain at the unit.	One of 11 generic hazard types used to categorize all SRS waste units. (Definitions in Appendix K.)	Remedial action in place for soils media. (Alpha numeric corresponds to actions defined in Appendix K; check mark denotes remedial action as yet to be determined.)	Remedial action in place for groundwater media. (Alpha numeric corresponds to actions defined in Appendix D; check mark denotes remedial action as yet to be determined.)
49	A-AREA RUBBLE PIT, 731-2A	Upper Three Runs	A	10-4 to 10-6	In Remediation		5	√	√
101	MISCELLANEOUS CHEMICAL BASIN, 731-4A	Upper Three Runs	A	> 10-4	In Remediation		6	√	√
102	METALS BURNING PITS, 731-5A	Upper Three Runs	A	10-4 to 10-6	In Remediation		5	√	
155	B-AREA TOWER FOUNDATION RUBBLE PILE, NBN	Savannah River / Floodplain / Swamp	B	< 10-6	Complete		5	A.1	
21	NON-RADIOACTIVE WASTE DISPOSAL FACILITY (AKA SANITARY LANDFILL RCRA PORTION), 740-G	Upper Three Runs	B	10-4 to 10-6	Complete	√	5	A.2, A.3	
22	NON-RADIOACTIVE WASTE DISPOSAL FACILITY (AKA SANITARY LANDFILL) (GROUNDWATER), 740-G	Upper Three Runs	B	10-4 to 10-6	Complete	√	5		B.2, B.3, B.6
37	GRACE ROAD SITE, 631-22G	Upper Three Runs	B	< 10-6	Complete		5	A.1	
149	LOWER KATO ROAD SITE, 761-1G	Upper Three Runs	B	< 10-6	Complete		9	A.1	

Table 4.3a*
RBES Planned End State By Area

*Data Consistantw/2004 PMP

Unit Index #	Unit Name	Watershed	Facility Area	FY03 Estimated Risk	Status	Institutional Controls in Place	Waste Unit Group (Hazard Type)	Soil Remedial Action	Groundwater Remedial Action (NA)
SRS unique identification waste unit number	Unit Name with facility or building number (NBN = no building number).	One of six SRS Watersheds where the unit resides.	Specific SRS geographic area unit resides.	Relative level of risk to a receptor from the unit, with $<10^{-6}$ being the lowest level and $>>10^{-4}$ being the greatest.	Status of unit in the regulatory cleanup process.	Units checked have SRS controls in place to restrict inappropriate uses of land or facilities when contaminants remain at the unit.	One of 11 generic hazard types used to categorize all SRS waste units. (Definitions in Appendix K.)	Remedial action in place for soils media. (Alpha numeric corresponds to actions defined in Appendix K; check mark denotes remedial action as yet to be determined.)	Remedial action in place for groundwater media. (Alpha numeric corresponds to actions defined in Appendix D; check mark denotes remedial action as yet to be determined.)
151	ORANGEBURG SITE, 761-2G	Upper Three Runs	B	$< 10^{-6}$	Complete		9	A.1	
167	IMHOFF TANK RUBBLE PILE, NBN	Upper Three Runs	B	$< 10^{-6}$	Complete		5	A.2, A.3	
168	KATO ROAD SITE, 761-6G	Upper Three Runs	B	$< 10^{-6}$	Complete		9	A.1	
204	TCU RUBBLE PILE, NBN	Upper Three Runs	B	$< 10^{-6}$	Complete		9	A.1	
207	ZION FAIR CHURCH SITE, NBN	Upper Three Runs	B	$< 10^{-6}$	Complete		9	A.1	
209	B-AREA SANITARY TREATMENT PLANT RUBBLE PILE, NBN	Upper Three Runs	B	$< 10^{-6}$	Complete		5	A.1	
529	ECODS B-4 (EAST OF B AREA, SOUTH OF ROAD C)	Upper Three Runs	B	$< 10^{-6}$	Complete		5	A.1	
526	ECODS B-1A, 1B (SOUTH OF B AREA)	Upper Three Runs	B	10^{-4} to 10^{-6}	Complete		5	√	
527	ECODS B-2 (SOUTH OF B AREA)	Upper Three Runs	B	10^{-4} to 10^{-6}	Complete		5	√	
491	SANDBLAST AREA CMB-001, NBN	Upper Three Runs	B	10^{-4} to 10^{-6}	In Assessment Phase		9	√	

Table 4.3a*
RBES Planned End State By Area

*Data Consistantw/2004 PMP

Unit Index #	Unit Name	Watershed	Facility Area	FY03 Estimated Risk	Status	Institutional Controls in Place	Waste Unit Group (Hazard Type)	Soil Remedial Action	Groundwater Remedial Action (NA)
SRS unique identification waste unit number	Unit Name with facility or building number (NBN = no building number).	One of six SRS Watersheds where the unit resides.	Specific SRS geographic area unit resides.	Relative level of risk to a receptor from the unit, with $<10^{-6}$ being the lowest level and $>>10^{-4}$ being the greatest.	Status of unit in the regulatory cleanup process.	Units checked have SRS controls in place to restrict inappropriate uses of land or facilities when contaminants remain at the unit.	One of 11 generic hazard types used to categorize all SRS waste units. (Definitions in Appendix K.)	Remedial action in place for soils media. (Alpha numeric corresponds to actions defined in Appendix K; check mark denotes remedial action as yet to be determined.)	Remedial action in place for groundwater media. (Alpha numeric corresponds to actions defined in Appendix D; check mark denotes remedial action as yet to be determined.)
528	ECODS B-3 (EAST OF B AREA, SOUTH OF ROAD C)	Upper Three Runs	B	10-4 to 10-6	In Assessment Phase		5	√	
530	ECODS B-5 (ADJACENT TO ECODS B-3)	Upper Three Runs	B	10-4 to 10-6	In Assessment Phase		5	√	
1	TANK 105-C HAZARDOUS WASTE MANAGEMENT FACILITY	Fourmile Branch	C	$< 10^{-6}$	Complete		2	A.7//A.1	
52	C-AREA COAL PILE RUNOFF BASIN, 189-C	Fourmile Branch	C	$< 10^{-6}$	Complete		3	A.7//A.1	
53	C-AREA REACTOR SEEPAGE BASINS, 904-066G	Fourmile Branch	C	10-4 to 10-6	Complete	√	2	A.2, A.3, A.4	
54	C-AREA REACTOR SEEPAGE BASINS, 904-067G	Fourmile Branch	C	10-4 to 10-6	Complete	√	2	A.2, A.3, A.4	
55	C-AREA REACTOR SEEPAGE BASINS, 904-068G	Fourmile Branch	C	10-4 to 10-6	Complete	√	2	A.2, A.3, A.4	
156	C-AREA ASBESTOS PIT, 080-21G	Fourmile Branch	C	$< 10^{-6}$	Complete		5	A.1	
157	C-AREA ASBESTOS PIT, 080-22G	Fourmile Branch	C	$< 10^{-6}$	Complete		5	A.1	

Table 4.3a*
RBES Planned End State By Area

***Data Consistantw/2004 PMP**

Unit Index #	Unit Name	Watershed	Facility Area	FY03 Estimated Risk	Status	Institutional Controls in Place	Waste Unit Group (Hazard Type)	Soil Remedial Action	Groundwater Remedial Action (NA)
SRS unique identification waste unit number	Unit Name with facility or building number (NBN = no building number).	One of six SRS Watersheds where the unit resides.	Specific SRS geographic area unit resides.	Relative level of risk to a receptor from the unit, with $<10^{-6}$ being the lowest level and $>>10^{-4}$ being the greatest.	Status of unit in the regulatory cleanup process.	Units checked have SRS controls in place to restrict inappropriate uses of land or facilities when contaminants remain at the unit.	One of 11 generic hazard types used to categorize all SRS waste units. (Definitions in Appendix K.)	Remedial action in place for soils media. (Alpha numeric corresponds to actions defined in Appendix K; check mark denotes remedial action as yet to be determined.)	Remedial action in place for groundwater media. (Alpha numeric corresponds to actions defined in Appendix D; check mark denotes remedial action as yet to be determined.)
158	C-AREA ASH PILE, 188-1C	Fourmile Branch	C	$< 10^{-6}$	Complete		3	A.7//A.1	
159	C-AREA ASH PILE, 188-2C	Fourmile Branch	C	$< 10^{-6}$	Complete		3	A.7//A.1	
194	SPILL ON 10/08/83 OF 800 GAL OF LOW LEVEL WATER NEAR 105-C, NBN	Fourmile Branch	C	$< 10^{-6}$	Complete		9	A.1	
201	SPILL ON 05/08/75 OF 50 GAL OF WASTE WATER - RAD, NBN	Fourmile Branch	C	$< 10^{-6}$	Complete		9	A.1	
241	C-AREA EROSION CONTROL SITE, 131-1C	Fourmile Branch	C	$< 10^{-6}$	Complete		9	A.1	
257	COMBINED SPILLS FROM 183-2C, NBN	Fourmile Branch	C	$< 10^{-6}$	Complete		9	A.1	
373	SPILL ON 01/12/80 OF <5 GAL OF WASTE WATER - RAD, NBN	Fourmile Branch	C	$< 10^{-6}$	Complete		9	A.1	
392	SPILL ON 02/12/84 OF 200 GAL OF TRITIATED WATER IN C-AREA, NBN	Fourmile Branch	C	$< 10^{-6}$	Complete		9	A.1	
427	SPILL ON 05/23/75 OF 3 GAL OF WASTE WATER - RAD, NBN	Fourmile Branch	C	$< 10^{-6}$	Complete		9	A.1	

Table 4.3a*
RBES Planned End State By Area

***Data Consistantw/2004 PMP**

Unit Index #	Unit Name	Watershed	Facility Area	FY03 Estimated Risk	Status	Institutional Controls in Place	Waste Unit Group (Hazard Type)	Soil Remedial Action	Groundwater Remedial Action (NA)
SRS unique identification waste unit number	Unit Name with facility or building number (NBN = no building number).	One of six SRS Watersheds where the unit resides.	Specific SRS geographic area unit resides.	Relative level of risk to a receptor from the unit, with $<10^{-6}$ being the lowest level and $>>10^{-4}$ being the greatest.	Status of unit in the regulatory cleanup process.	Units checked have SRS controls in place to restrict inappropriate uses of land or facilities when contaminants remain at the unit.	One of 11 generic hazard types used to categorize all SRS waste units. (Definitions in Appendix K.)	Remedial action in place for soils media. (Alpha numeric corresponds to actions defined in Appendix K; check mark denotes remedial action as yet to be determined.)	Remedial action in place for groundwater media. (Alpha numeric corresponds to actions defined in Appendix D; check mark denotes remedial action as yet to be determined.)
492	SANDBLAST AREA CMC-001, NBN	Fourmile Branch	C	$< 10^{-6}$	Complete		9	A.1	
493	SANDBLAST AREA CMC-002, NBN	Fourmile Branch	C	$< 10^{-6}$	Complete		9	A.1	
494	SANDBLAST AREA CMC-003, NBN	Fourmile Branch	C	$< 10^{-6}$	Complete		9	A.1	
516	COMBINED SPILLS FROM 105-C, 106-C, AND 109-C, NBN	Fourmile Branch	C	$< 10^{-6}$	Complete		9	A.1	
522	ECODS C-1 (NEAR C-AREA REACTOR DISCHARGE CANAL)	Fourmile Branch	C	$< 10^{-6}$	In Assessment Phase		5	A.1, A.2	
146	C-AREA REACTOR GROUNDWATER	Fourmile Branch	C	$> 10^{-4}$	In Assessment Phase		10		√
210	C-AREA ASH PILE, 188-0C	Fourmile Branch	C	10^{-4} to 10^{-6}	In Assessment Phase		3	√	
240	C-AREA DISASSEMBLY BASIN, 105-C	Fourmile Branch	C	$> 10^{-4}$	In Assessment Phase		2	√	
242	C-AREA REACTOR COOLING WATER SYSTEM, 186/190-C	Fourmile Branch	C	10^{-4} to 10^{-6}	In Assessment Phase		2	√	
475	C AREA: C-AREA REACTOR AREA CASK CAR RAILROAD	Fourmile Branch	C	$> 10^{-4}$	In Assessment Phase		5	√	

Table 4.3a*
RBES Planned End State By Area

*Data Consistantw/2004 PMP

Unit Index #	Unit Name	Watershed	Facility Area	FY03 Estimated Risk	Status	Institutional Controls in Place	Waste Unit Group (Hazard Type)	Soil Remedial Action	Groundwater Remedial Action (NA)
SRS unique identification waste unit number	Unit Name with facility or building number (NBN = no building number).	One of six SRS Watersheds where the unit resides.	Specific SRS geographic area unit resides.	Relative level of risk to a receptor from the unit, with $<10^{-6}$ being the lowest level and $>>10^{-4}$ being the greatest.	Status of unit in the regulatory cleanup process.	Units checked have SRS controls in place to restrict inappropriate uses of land or facilities when contaminants remain at the unit.	One of 11 generic hazard types used to categorize all SRS waste units. (Definitions in Appendix K.)	Remedial action in place for soils media. (Alpha numeric corresponds to actions defined in Appendix K; check mark denotes remedial action as yet to be determined.)	Remedial action in place for groundwater media. (Alpha numeric corresponds to actions defined in Appendix D; check mark denotes remedial action as yet to be determined.)
	TRACKS AS ABANDONED, NBN								
489	C-AREA ASH PILE OFF POWER LINE ROAD, NBN	Fourmile Branch	C	10-4 to 10-6	In Assessment Phase		3	√	
511	C-AREA REACTOR DISCHARGE CANAL, NBN	Fourmile Branch	C	> 10-4	In Assessment Phase		9	√	
555	C-AREA PROCESS SEWER LINES AS ABANDONED, NBN	Fourmile Branch	C	> 10-4	In Assessment Phase	√	4	√	
566	OLD C-AREA BURNING/RUBBLE PIT, NBN	Fourmile Branch	C	> 10-4	In Assessment Phase		5	√	
51	C-AREA BURNING/RUBBLE PIT, 131-C	Fourmile Branch	C	> 10-4	In Remediation		5	√	√
26	D-AREA OIL SEEPAGE BASIN, 631-G	Savannah River / Floodplain / Swamp	D	10 -4 to 10-6	Complete	√	6	A.2, A.3, A.7	B.2, B.3
32	D-AREA BURNING/RUBBLE PITS, 431-1D	Savannah River / Floodplain / Swamp	D	10 -4 to 10-6	Complete	√	5	A.2	B.2
33	D-AREA BURNING/RUBBLE PITS, 431-D	Savannah River / Floodplain / Swamp	D	10 -4 to 10-6	Complete	√	5	A.2	B.2

Table 4.3a*
RBES Planned End State By Area

*Data Consistantw/2004 PMP

Unit Index #	Unit Name	Watershed	Facility Area	FY03 Estimated Risk	Status	Institutional Controls in Place	Waste Unit Group (Hazard Type)	Soil Remedial Action	Groundwater Remedial Action (NA)
SRS unique identification waste unit number	Unit Name with facility or building number (NBN = no building number).	One of six SRS Watersheds where the unit resides.	Specific SRS geographic area unit resides.	Relative level of risk to a receptor from the unit, with $<10^{-6}$ being the lowest level and $>>10^{-4}$ being the greatest.	Status of unit in the regulatory cleanup process.	Units checked have SRS controls in place to restrict inappropriate uses of land or facilities when contaminants remain at the unit.	One of 11 generic hazard types used to categorize all SRS waste units. (Definitions in Appendix K.)	Remedial action in place for soils media. (Alpha numeric corresponds to actions defined in Appendix K; check mark denotes remedial action as yet to be determined.)	Remedial action in place for groundwater media. (Alpha numeric corresponds to actions defined in Appendix D; check mark denotes remedial action as yet to be determined.)
219	SANDBLAST AREA CMD-003, NBN	Savannah River / Floodplain / Swamp	D	$< 10^{-6}$	Complete		9	A.1	
220	SANDBLAST AREA CMD-001, NBN	Savannah River / Floodplain / Swamp	D	$< 10^{-6}$	Complete		9	A.1	
232	412-D, 401-D, AND 402-D HEAVY WATER FACILITY AND GAS PLANT (ASBESTOS REMOVAL)	Savannah River / Floodplain / Swamp	D	$< 10^{-6}$	Complete		2	A.1	
349	SANDBLAST AREA CMD-002, NBN	Savannah River / Floodplain / Swamp	D	$< 10^{-6}$	Complete		9	A.1	
370	SPILL ON 01/01/86 OF 2 GAL OF 50% SODIUM HYDROXIDE, NBN	Savannah River / Floodplain / Swamp	D	$< 10^{-6}$	Complete		9	A.1	
389	SPILL ON 12/02/81 OF 800 LB OF HYDROGEN SULFIDE, NBN	Savannah River / Floodplain / Swamp	D	$< 10^{-6}$	Complete		9	A.1	
421	SPILL ON 05/12/81 OF 400 LB OF HYDROGEN SULFIDE, NBN	Savannah River / Floodplain / Swamp	D	$< 10^{-6}$	Complete		9	A.1	
441	SPILL ON 06/03/86 OF 5 GAL OF NEUTRALIZATION SYSTEM WATER, NBN	Savannah River / Floodplain / Swamp	D	$< 10^{-6}$	Complete		9	A.1	

Table 4.3a*
RBES Planned End State By Area

*Data Consistantw/2004 PMP

Unit Index #	Unit Name	Watershed	Facility Area	FY03 Estimated Risk	Status	Institutional Controls in Place	Waste Unit Group (Hazard Type)	Soil Remedial Action	Groundwater Remedial Action (NA)
SRS unique identification waste unit number	Unit Name with facility or building number (NBN = no building number).	One of six SRS Watersheds where the unit resides.	Specific SRS geographic area unit resides.	Relative level of risk to a receptor from the unit, with $<10^{-6}$ being the lowest level and $>>10^{-4}$ being the greatest.	Status of unit in the regulatory cleanup process.	Units checked have SRS controls in place to restrict inappropriate uses of land or facilities when contaminants remain at the unit.	One of 11 generic hazard types used to categorize all SRS waste units. (Definitions in Appendix K.)	Remedial action in place for soils media. (Alpha numeric corresponds to actions defined in Appendix K; check mark denotes remedial action as yet to be determined.)	Remedial action in place for groundwater media. (Alpha numeric corresponds to actions defined in Appendix D; check mark denotes remedial action as yet to be determined.)
444	SPILL ON 07/21/79 OF UNKNOWN AMOUNT OF ACID IN D-AREA, NBN	Savannah River / Floodplain / Swamp	D	$< 10^{-6}$	Complete		9	A.1	
448	SPILL ON 08/31/87 OF <100 GAL OF BROMOCIDE SOLN FROM 607-14D, NBN	Savannah River / Floodplain / Swamp	D	$< 10^{-6}$	Complete		9	A.1	
468	SANDBLAST AREA CMD-004, NBN	Savannah River / Floodplain / Swamp	D	$< 10^{-6}$	Complete		9	A.1	
229	UNIDENTIFIED TRASH PILE, NBN	Savannah River / Floodplain / Swamp	D	10-4 to 10-6	Complete		5	√	
68	D-AREA ASH BASIN, 488-D	Savannah River / Floodplain / Swamp	D	$> 10^{-4}$	In Assessment Phase		3	√	
69	D-AREA COAL PILE RUNOFF BASIN, 489-D	Savannah River / Floodplain / Swamp	D	10-4 to 10-6	In Assessment Phase		3	√	
70	D-AREA WASTE OIL FACILITY, 484-D	Savannah River / Floodplain / Swamp	D	10-4 to 10-6	In Assessment Phase		9	√	
211	D-AREA ASBESTOS PIT, 080-20G	Savannah River / Floodplain / Swamp	D	10-4 to 10-6	In Assessment Phase		5	√	
238	D-AREA ASH BASIN, 488-1D	Savannah River / Floodplain / Swamp	D	$> 10^{-4}$	In Assessment Phase		3	√	

Table 4.3a*
RBES Planned End State By Area

*Data Consistantw/2004 PMP

Unit Index #	Unit Name	Watershed	Facility Area	FY03 Estimated Risk	Status	Institutional Controls in Place	Waste Unit Group (Hazard Type)	Soil Remedial Action	Groundwater Remedial Action (NA)
SRS unique identification waste unit number	Unit Name with facility or building number (NBN = no building number).	One of six SRS Watersheds where the unit resides.	Specific SRS geographic area unit resides.	Relative level of risk to a receptor from the unit, with $<10^{-6}$ being the lowest level and $>>10^{-4}$ being the greatest.	Status of unit in the regulatory cleanup process.	Units checked have SRS controls in place to restrict inappropriate uses of land or facilities when contaminants remain at the unit.	One of 11 generic hazard types used to categorize all SRS waste units. (Definitions in Appendix K.)	Remedial action in place for soils media. (Alpha numeric corresponds to actions defined in Appendix K; check mark denotes remedial action as yet to be determined.)	Remedial action in place for groundwater media. (Alpha numeric corresponds to actions defined in Appendix D; check mark denotes remedial action as yet to be determined.)
265	COMBINED SPILLS FROM 483-D AND ASSOCIATED AREAS, NBN	Savannah River / Floodplain / Swamp	D	10-4 to 10-6	In Assessment Phase		9	√	
272	D-AREA ASH BASIN, 488-2D	Savannah River / Floodplain / Swamp	D	> 10-4	In Assessment Phase		3	√	
273	D-AREA RUBBLE PIT, 431-2D	Savannah River / Floodplain / Swamp	D	10-4 to 10-6	In Assessment Phase		5	√	
520	D-AREA UPGRADIENT SOURCES	Savannah River / Floodplain / Swamp	D	10-4 to 10-6	In Assessment Phase		10		√
543	ECODS D-1 (NEAR D-AREA RUBBLE PILE, 431-2D)	Savannah River / Floodplain / Swamp	D	10-4 to 10-6	In Assessment Phase		5	√	
548	D-AREA ASH BASIN, 488-4D	Savannah River / Floodplain / Swamp	D	> 10-4	In Assessment Phase		3	√	
16	MIXED WASTE MANAGEMENT FACILITY (INCLUDING THE RCRA REGULATED PORTIONS OF LLRWF 643-7E), 643-28E	Fourmile Branch	E	10-4 to 10-6	Complete	√	1	A.2, A.3	
523	ECODS F-1 (SOUTHEAST OF F-AREA ASH BASIN, 276-0F)	Fourmile Branch	E	< 10-6	Complete		5	A.1	

Table 4.3a*
RBES Planned End State By Area

***Data Consistantw/2004 PMP**

Unit Index #	Unit Name	Watershed	Facility Area	FY03 Estimated Risk	Status	Institutional Controls in Place	Waste Unit Group (Hazard Type)	Soil Remedial Action	Groundwater Remedial Action (NA)
SRS unique identification waste unit number	Unit Name with facility or building number (NBN = no building number).	One of six SRS Watersheds where the unit resides.	Specific SRS geographic area unit resides.	Relative level of risk to a receptor from the unit, with $<10^{-6}$ being the lowest level and $>>10^{-4}$ being the greatest.	Status of unit in the regulatory cleanup process.	Units checked have SRS controls in place to restrict inappropriate uses of land or facilities when contaminants remain at the unit.	One of 11 generic hazard types used to categorize all SRS waste units. (Definitions in Appendix K.)	Remedial action in place for soils media. (Alpha numeric corresponds to actions defined in Appendix K; check mark denotes remedial action as yet to be determined.)	Remedial action in place for groundwater media. (Alpha numeric corresponds to actions defined in Appendix D; check mark denotes remedial action as yet to be determined.)
524	ECODS F-3 (EAST OF ECOD F-1)	Fourmile Branch	E	$< 10^{-6}$	Complete		5	A.1	
571	Low Level Radioactive Disposal Facility (RCRA Portion)	Fourmile Branch	E	10-4 to 10-6	Complete	√	1	A.2, A.3	
18	OLD RADIOACTIVE WASTE BURIAL GROUND (INCLUDING SOLVENT TANKS 650-01E-22E) 643-E	Fourmile Branch	E	$> 10^{-4}$	In Remediation		1	√	
20	LOW LEVEL RADIOACTIVE WASTE DISPOSAL FACILITY (NON-HAZARDOUS WASTE DISPOSAL PORTION OF 643-7E), 643-7E	Fourmile Branch	E	$> 10^{-4}$	In Remediation		1	√	
103	MIXED WASTE MANAGEMENT FACILITY (GROUNDWATER)	Fourmile Branch	E	$> 10^{-4}$	In Remediation		10		√
3	F-AREA HAZARDOUS WASTE MANAGEMENT FACILITY (F-AREA SEEPAGE BASIN, 904-41G)	Fourmile Branch	F	10-4 to 10-6	Complete	√	2	A.2, A.3	B.2

Table 4.3a*
RBES Planned End State By Area

*Data Consistantw/2004 PMP

Unit Index #	Unit Name	Watershed	Facility Area	FY03 Estimated Risk	Status	Institutional Controls in Place	Waste Unit Group (Hazard Type)	Soil Remedial Action	Groundwater Remedial Action (NA)
SRS unique identification waste unit number	Unit Name with facility or building number (NBN = no building number).	One of six SRS Watersheds where the unit resides.	Specific SRS geographic area unit resides.	Relative level of risk to a receptor from the unit, with $<10^{-6}$ being the lowest level and $>>10^{-4}$ being the greatest.	Status of unit in the regulatory cleanup process.	Units checked have SRS controls in place to restrict inappropriate uses of land or facilities when contaminants remain at the unit.	One of 11 generic hazard types used to categorize all SRS waste units. (Definitions in Appendix K.)	Remedial action in place for soils media. (Alpha numeric corresponds to actions defined in Appendix K; check mark denotes remedial action as yet to be determined.)	Remedial action in place for groundwater media. (Alpha numeric corresponds to actions defined in Appendix D; check mark denotes remedial action as yet to be determined.)
4	F-AREA HAZARDOUS WASTE MANAGEMENT FACILITY (F-AREA SEEPAGE BASIN, 904-42G)	Fourmile Branch	F	10-4 to 10-6	Complete	√	2	A.2, A.3	B.2
5	F-AREA HAZARDOUS WASTE MANAGEMENT FACILITY (F-AREA SEEPAGE BASIN, 904-43G)	Fourmile Branch	F	10-4 to 10-6	Complete	√	2	A.2, A.3	B.2
71	F-AREA COAL PILE RUNOFF BASIN, 289-F	Fourmile Branch	F	$< 10^{-6}$	Complete		3	A.7//A.1	
72	F-AREA HAZARDOUS WASTE MANAGEMENT FACILITY (F-AREA INACTIVE PROCESS SEWER LINE 081-1F)	Fourmile Branch	F	$< 10^{-6}$	Complete		4	A.2, A.3	B.2
73	F-AREA RETENTION BASIN, 281-3F	Fourmile Branch	F	10-4 to 10-6	Complete	√	2	A.2, A.3, A.4	B.2
129	SPILL ON 05/24/84 OF 550 GAL OF SIMULATED SALT SOLUTION, PIZZOLITH 122R IN 643-7	Fourmile Branch	F	$< 10^{-6}$	Complete		9	A.1	
223	SPILL ON 01/01/59 OF UNKNOWN OF SEEPAGE BASIN PIPE	Fourmile Branch	F	$< 10^{-6}$	Complete		9	A.1	

Table 4.3a*
RBES Planned End State By Area

*Data Consistantw/2004 PMP

Unit Index #	Unit Name	Watershed	Facility Area	FY03 Estimated Risk	Status	Institutional Controls in Place	Waste Unit Group (Hazard Type)	Soil Remedial Action	Groundwater Remedial Action (NA)
SRS unique identification waste unit number	Unit Name with facility or building number (NBN = no building number).	One of six SRS Watersheds where the unit resides.	Specific SRS geographic area unit resides.	Relative level of risk to a receptor from the unit, with $<10^{-6}$ being the lowest level and $>>10^{-4}$ being the greatest.	Status of unit in the regulatory cleanup process.	Units checked have SRS controls in place to restrict inappropriate uses of land or facilities when contaminants remain at the unit.	One of 11 generic hazard types used to categorize all SRS waste units. (Definitions in Appendix K.)	Remedial action in place for soils media. (Alpha numeric corresponds to actions defined in Appendix K; check mark denotes remedial action as yet to be determined.)	Remedial action in place for groundwater media. (Alpha numeric corresponds to actions defined in Appendix D; check mark denotes remedial action as yet to be determined.)
	LEAK BETWEEN 904-42G, 904-43G								
281	F-AREA SANITARY SLUDGE LAND APPLICATION SITE, NBN	Fourmile Branch	F	$< 10^{-6}$	Complete		7	A.1	
363	SPILL ON 01/01/78 OF 50 GAL OF 50% SODIUM HYDROXIDE, NBN	Fourmile Branch	F	$< 10^{-6}$	Complete		9	A.1	
402	SPILL ON 03/27/80 OF 3 GAL OF NITRIC ACID, NBN	Fourmile Branch	F	$< 10^{-6}$	Complete		9	A.1	
445	SPILL ON 07/05/88 OF 2 PINT OF 64% NITRIC ACID IN F-AREA, NBN	Fourmile Branch	F	$< 10^{-6}$	Complete		9	A.1	
2	F-AREA ACID/CAUSTIC BASIN, 904-47G	Upper Three Runs	F	$< 10^{-6}$	Complete		8	A.1, A.3	
30	BURMA ROAD RUBBLE PIT, 231-4F	Upper Three Runs	F	$< 10^{-6}$	Complete		5	A.1	
34	F-AREA BURNING/RUBBLE PITS, 231-1F	Upper Three Runs	F	10-4 to 10-6	Complete	√	5	A.2	
35	F-AREA BURNING/RUBBLE PITS, 231-2F	Upper Three Runs	F	10-4 to 10-6	Complete	√	5	A.2	

Table 4.3a*
RBES Planned End State By Area

*Data Consistantw/2004 PMP

Unit Index #	Unit Name	Watershed	Facility Area	FY03 Estimated Risk	Status	Institutional Controls in Place	Waste Unit Group (Hazard Type)	Soil Remedial Action	Groundwater Remedial Action (NA)
SRS unique identification waste unit number	Unit Name with facility or building number (NBN = no building number).	One of six SRS Watersheds where the unit resides.	Specific SRS geographic area unit resides.	Relative level of risk to a receptor from the unit, with $<10^{-6}$ being the lowest level and $>>10^{-4}$ being the greatest.	Status of unit in the regulatory cleanup process.	Units checked have SRS controls in place to restrict inappropriate uses of land or facilities when contaminants remain at the unit.	One of 11 generic hazard types used to categorize all SRS waste units. (Definitions in Appendix K.)	Remedial action in place for soils media. (Alpha numeric corresponds to actions defined in Appendix K; check mark denotes remedial action as yet to be determined.)	Remedial action in place for groundwater media. (Alpha numeric corresponds to actions defined in Appendix D; check mark denotes remedial action as yet to be determined.)
36	F-AREA BURNING/RUBBLE PITS, 231-F	Upper Three Runs	F	10-4 to 10-6	Complete	√	5	A.2	
105	OLD F-AREA SEEPAGE BASIN, 904-49G	Upper Three Runs	F	10-4 to 10-6	Complete	√	2	A.2, A.3, A.4, A.7	B.2, B.3
162	FIRE TRAINING PIT AT 709-1F, NBN	Upper Three Runs	F	$< 10^{-6}$	Complete		9	A.1	
199	SPILL ON 04/15/87 OF 950 GAL OF CHROMATED WATER FROM 772-F, NBN	Upper Three Runs	F	$< 10^{-6}$	Complete		9	A.1	
200	SPILL ON 05/01/57 OF 125 FT2 OF RAD LIQUID FROM SOLVENT TRAILER, NBN	Upper Three Runs	F	$< 10^{-6}$	Complete		9	A.1	
212	F-AREA SCRAP LUMBER PILE, 231-3F	Upper Three Runs	F	$< 10^{-6}$	Complete		5	A.1	
227	SPILL ON 05/14/85 OF 1/2 PINT OF MERCURY NEAR 284-F, NBN	Upper Three Runs	F	$< 10^{-6}$	Complete		9	A.1	
278	F-AREA EROSION CONTROL SITE, 080-28G	Upper Three Runs	F	$< 10^{-6}$	Complete		9	A.1	
279	F-AREA RAILROAD CROSSTIE PILE, NBN	Upper Three Runs	F	$< 10^{-6}$	Complete		5	A.1	

Table 4.3a*
RBES Planned End State By Area

*Data Consistantw/2004 PMP

Unit Index #	Unit Name	Watershed	Facility Area	FY03 Estimated Risk	Status	Institutional Controls in Place	Waste Unit Group (Hazard Type)	Soil Remedial Action	Groundwater Remedial Action (NA)
SRS unique identification waste unit number	Unit Name with facility or building number (NBN = no building number).	One of six SRS Watersheds where the unit resides.	Specific SRS geographic area unit resides.	Relative level of risk to a receptor from the unit, with $<10^{-6}$ being the lowest level and $>>10^{-4}$ being the greatest.	Status of unit in the regulatory cleanup process.	Units checked have SRS controls in place to restrict inappropriate uses of land or facilities when contaminants remain at the unit.	One of 11 generic hazard types used to categorize all SRS waste units. (Definitions in Appendix K.)	Remedial action in place for soils media. (Alpha numeric corresponds to actions defined in Appendix K; check mark denotes remedial action as yet to be determined.)	Remedial action in place for groundwater media. (Alpha numeric corresponds to actions defined in Appendix D; check mark denotes remedial action as yet to be determined.)
284	F-AREA ACID/CAUSTIC BASIN (GROUNDWATER)	Upper Three Runs	F	$< 10^{-6}$	Complete		10	A.1	B.1
325	POTENTIAL RELEASE OF NAOH/H2 SO4 FROM 280-1F, NBN	Upper Three Runs	F	$< 10^{-6}$	Complete		9	A.1	
362	SPILL ON 01/01/57 OF <1 CI OF BETA - GAMMA, NBN	Upper Three Runs	F	$< 10^{-6}$	Complete		9	A.1	
368	SPILL ON 01/01/85 OF 15 GAL OF 6% POTASSIUM PERMANGANATE, NBN	Upper Three Runs	F	$< 10^{-6}$	Complete		9	A.1	
372	SPILL ON 01/01/87 OF UNKNOWN OF POTASSIUM PERMANGANATE, NBN	Upper Three Runs	F	$< 10^{-6}$	Complete		9	A.1	
395	SPILL ON 02/25/87 OF 2 LITER OF SULFURIC ACID BETWEEN 704-8F AND 703-F PARKING L	Upper Three Runs	F	$< 10^{-6}$	Complete		9	A.1	
416	SPILL ON 04/07/76 OF 200 GAL OF 50% NITRIC ACID, NBN	Upper Three Runs	F	$< 10^{-6}$	Complete		9	A.1	
422	SPILL ON 05/19/87 OF 1 GAL OF 50% SODIUM HYDROXIDE, NBN	Upper Three Runs	F	$< 10^{-6}$	Complete		9	A.1	

Table 4.3a*
RBES Planned End State By Area

*Data Consistantw/2004 PMP

Unit Index #	Unit Name	Watershed	Facility Area	FY03 Estimated Risk	Status	Institutional Controls in Place	Waste Unit Group (Hazard Type)	Soil Remedial Action	Groundwater Remedial Action (NA)
SRS unique identification waste unit number	Unit Name with facility or building number (NBN = no building number).	One of six SRS Watersheds where the unit resides.	Specific SRS geographic area unit resides.	Relative level of risk to a receptor from the unit, with $<10^{-6}$ being the lowest level and $>>10^{-4}$ being the greatest.	Status of unit in the regulatory cleanup process.	Units checked have SRS controls in place to restrict inappropriate uses of land or facilities when contaminants remain at the unit.	One of 11 generic hazard types used to categorize all SRS waste units. (Definitions in Appendix K.)	Remedial action in place for soils media. (Alpha numeric corresponds to actions defined in Appendix K; check mark denotes remedial action as yet to be determined.)	Remedial action in place for groundwater media. (Alpha numeric corresponds to actions defined in Appendix D; check mark denotes remedial action as yet to be determined.)
424	SPILL ON 05/21/84 OF 20 GAL OF SODIUM HYDROXIDE, NBN	Upper Three Runs	F	$< 10^{-6}$	Complete		9	A.1	
426	SPILL ON 05/22/86 OF 2 GAL OF 50% SODIUM HYDROXIDE, NBN	Upper Three Runs	F	$< 10^{-6}$	Complete		9	A.1	
43	211-FB PU-239 RELEASE, 081-F	Fourmile Branch	F	10^{-4} to 10^{-6}	In Assessment Phase		9	√	
263	COMBINED SPILLS FROM 242-F, NBN	Fourmile Branch	F	$> 10^{-4}$	In Assessment Phase		9	√	
266	COMBINED SPILLS FROM 643-G, NBN	Fourmile Branch	F	$> 10^{-4}$	In Assessment Phase		9	√	
270	COMBINED SPILLS FROM 701-1F SPILL, NBN	Fourmile Branch	F	$> 10^{-4}$	In Assessment Phase		9	√	
277	F-AREA ASH BASIN, 288-1F	Fourmile Branch	F	10^{-4} to 10^{-6}	In Assessment Phase		3	√	
280	F-AREA RETENTION BASIN, 281-08F	Fourmile Branch	F	$> 10^{-4}$	In Assessment Phase		2	√	√
283	F-AREA TANK FARM, 241-F	Fourmile Branch	F	$>> 10^{-4}$	In Assessment Phase		2	√	
376	SPILL ON 01/19/83 OF 1000 FT2 OF RADIOACTIVE SPILL	Fourmile Branch	F	10^{-4} to 10^{-6}	In Assessment Phase		9	√	

Table 4.3a*
RBES Planned End State By Area

*Data Consistantw/2004 PMP

Unit Index #	Unit Name	Watershed	Facility Area	FY03 Estimated Risk	Status	Institutional Controls in Place	Waste Unit Group (Hazard Type)	Soil Remedial Action	Groundwater Remedial Action (NA)
SRS unique identification waste unit number	Unit Name with facility or building number (NBN = no building number).	One of six SRS Watersheds where the unit resides.	Specific SRS geographic area unit resides.	Relative level of risk to a receptor from the unit, with $<10^{-6}$ being the lowest level and $>>10^{-4}$ being the greatest.	Status of unit in the regulatory cleanup process.	Units checked have SRS controls in place to restrict inappropriate uses of land or facilities when contaminants remain at the unit.	One of 11 generic hazard types used to categorize all SRS waste units. (Definitions in Appendix K.)	Remedial action in place for soils media. (Alpha numeric corresponds to actions defined in Appendix K; check mark denotes remedial action as yet to be determined.)	Remedial action in place for groundwater media. (Alpha numeric corresponds to actions defined in Appendix D; check mark denotes remedial action as yet to be determined.)
380	SPILL ON 10/01/71 OF 100 SQ FT OF FLUSH WATER - RAD, NBN	Fourmile Branch	F	10-4 to 10-6	In Assessment Phase		9	√	
381	SPILL ON 10/16/81 OF 30 GAL OF LOW LEVEL WASTE FROM TRAILER, NBN	Fourmile Branch	F	10-4 to 10-6	In Assessment Phase		9	√	
399	SPILL ON 03/01/66 OF 500 SQ FT OF FLUSH WATER - RAD, NBN	Fourmile Branch	F	10-4 to 10-6	In Assessment Phase		9	√	
411	SPILL ON 04/14/81 OF 3 GAL OF CONTAMINATED FLUSH WATER, NBN	Fourmile Branch	F	10-4 to 10-6	In Assessment Phase		9	√	
418	SPILL ON 05/01/71 OF UNKNOWN OF SEEPAGE BASIN PIPE LEAK, NBN	Fourmile Branch	F	10-4 to 10-6	In Assessment Phase		9	√	
431	SPILL ON 05/28/81 OF 9000 GAL OF CHROMATED WATER, NBN	Fourmile Branch	F	10-4 to 10-6	In Assessment Phase		9	√	
432	SPILL ON 05/30/78 OF UNKNOWN OF SUMP OVERFLOW, NBN	Fourmile Branch	F	10-4 to 10-6	In Assessment Phase		9	√	
438	SPILL ON 06/26/75 OF 250 CU FT OF RAD CONTAMINATED SOIL,	Fourmile Branch	F	10-4 to 10-6	In Assessment Phase		9	√	

Table 4.3a*
RBES Planned End State By Area

*Data Consistantw/2004 PMP

Unit Index #	Unit Name	Watershed	Facility Area	FY03 Estimated Risk	Status	Institutional Controls in Place	Waste Unit Group (Hazard Type)	Soil Remedial Action	Groundwater Remedial Action (NA)
SRS unique identification waste unit number	Unit Name with facility or building number (NBN = no building number).	One of six SRS Watersheds where the unit resides.	Specific SRS geographic area unit resides.	Relative level of risk to a receptor from the unit, with $<10^{-6}$ being the lowest level and $>>10^{-4}$ being the greatest.	Status of unit in the regulatory cleanup process.	Units checked have SRS controls in place to restrict inappropriate uses of land or facilities when contaminants remain at the unit.	One of 11 generic hazard types used to categorize all SRS waste units. (Definitions in Appendix K.)	Remedial action in place for soils media. (Alpha numeric corresponds to actions defined in Appendix K; check mark denotes remedial action as yet to be determined.)	Remedial action in place for groundwater media. (Alpha numeric corresponds to actions defined in Appendix D; check mark denotes remedial action as yet to be determined.)
	NBN								
442	SPILL ON 06/06/79 OF <1 GAL OF CONTAMINATED LIQUID, NBN	Fourmile Branch	F	10-4 to 10-6	In Assessment Phase		9	√	
490	SPILL ON 04/57 OF RAD LIQUID FROM SOLVENT TRAILER, NBN	Fourmile Branch	F	10-4 to 10-6	In Assessment Phase		9	√	
141	F-AREA INACTIVE PROCESS SEWER LINES FROM BUILDING TO THE SECURITY FENCE, 081-1F	Upper Three Runs	F	> 10-4	In Assessment Phase		4	√	
276	F-AREA ASH BASIN, 288-0F	Upper Three Runs	F	10-4 to 10-6	In Assessment Phase		3	√	
308	LOW LEVEL RADIOACTIVE DRAIN LINES, 772-F	Upper Three Runs	F	10-4 to 10-6	In Assessment Phase		4	√	
343	SANDBLAST AREA CMF-001, NBN	Upper Three Runs	F	10-4 to 10-6	In Assessment Phase		9	√	
394	SPILL ON 02/25/85 OF 20000 CM OF WATER VAPOR - RAD, NBN	Upper Three Runs	F	10-4 to 10-6	In Assessment Phase		9	√	

Table 4.3a*
RBES Planned End State By Area

*Data Consistantw/2004 PMP

Unit Index #	Unit Name	Watershed	Facility Area	FY03 Estimated Risk	Status	Institutional Controls in Place	Waste Unit Group (Hazard Type)	Soil Remedial Action	Groundwater Remedial Action (NA)
SRS unique identification waste unit number	Unit Name with facility or building number (NBN = no building number).	One of six SRS Watersheds where the unit resides.	Specific SRS geographic area unit resides.	Relative level of risk to a receptor from the unit, with $<10^{-6}$ being the lowest level and $>>10^{-4}$ being the greatest.	Status of unit in the regulatory cleanup process.	Units checked have SRS controls in place to restrict inappropriate uses of land or facilities when contaminants remain at the unit.	One of 11 generic hazard types used to categorize all SRS waste units. (Definitions in Appendix K.)	Remedial action in place for soils media. (Alpha numeric corresponds to actions defined in Appendix K; check mark denotes remedial action as yet to be determined.)	Remedial action in place for groundwater media. (Alpha numeric corresponds to actions defined in Appendix D; check mark denotes remedial action as yet to be determined.)
414	SPILL ON 04/24/91 OF .11 CI OF PU 239, 772-1F	Upper Three Runs	F	10-4 to 10-6	In Assessment Phase		9	√	
429	SPILL ON 05/26/88 OF 10 GAL OF ETHYLENE GLYCOL-RAD FROM 772-F, NBN	Upper Three Runs	F	10-4 to 10-6	In Assessment Phase		9	√	
435	SPILL ON 06/01/59 OF <1 CI OF SEGREGATED SOLVENT FROM 211-F, NBN	Upper Three Runs	F	10-4 to 10-6	In Assessment Phase		9	√	
485	COMBINED SPILLS FROM 221-F, NBN	Upper Three Runs	F	10-4 to 10-6	In Assessment Phase		9	√	
19	F & H-AREA HAZARDOUS WASTE MANAGEMENT FACILITIES (GROUNDWATER)	Fourmile Branch	F	> 10-4	In Remediation		10		√
575	GENERAL SEPARATIONS AREA WESTERN GROUNDWATER OPERABLE UNIT, NBN	Upper Three Runs	F	> 10-4	In Remediation		10		√
6	H-AREA ACID/CAUSTIC BASIN, 904-75G	Fourmile Branch	H	< 10-6	Complete		8	A.1, A.3	

Table 4.3a*
RBES Planned End State By Area

*Data Consistantw/2004 PMP

Unit Index #	Unit Name	Watershed	Facility Area	FY03 Estimated Risk	Status	Institutional Controls in Place	Waste Unit Group (Hazard Type)	Soil Remedial Action	Groundwater Remedial Action (NA)
SRS unique identification waste unit number	Unit Name with facility or building number (NBN = no building number).	One of six SRS Watersheds where the unit resides.	Specific SRS geographic area unit resides.	Relative level of risk to a receptor from the unit, with $<10^{-6}$ being the lowest level and $>>10^{-4}$ being the greatest.	Status of unit in the regulatory cleanup process.	Units checked have SRS controls in place to restrict inappropriate uses of land or facilities when contaminants remain at the unit.	One of 11 generic hazard types used to categorize all SRS waste units. (Definitions in Appendix K.)	Remedial action in place for soils media. (Alpha numeric corresponds to actions defined in Appendix K; check mark denotes remedial action as yet to be determined.)	Remedial action in place for groundwater media. (Alpha numeric corresponds to actions defined in Appendix D; check mark denotes remedial action as yet to be determined.)
7	H-AREA HAZARDOUS WASTE MANAGEMENT FACILITY (H-AREA SEEPAGE BASIN, 904-44G)	Fourmile Branch	H	10-4 to 10-6	Complete	√	2	A.2, A.3	B.2
8	H-AREA HAZARDOUS WASTE MANAGEMENT FACILITY (H-AREA SEEPAGE BASIN, 904-46G)	Fourmile Branch	H	10-4 to 10-6	Complete	√	2	A.2, A.3	B.2
9	H-AREA HAZARDOUS WASTE MANAGEMENT FACILITY (H-AREA SEEPAGE BASIN, 904-45G)	Fourmile Branch	H	10-4 to 10-6	Complete	√	2	A.2, A.3	B.2
10	H-AREA HAZARDOUS WASTE MANAGEMENT FACILITY (H-AREA SEEPAGE BASIN, 904-56G)	Fourmile Branch	H	10-4 to 10-6	Complete	√	2	A.2, A.3	B.2
80	H-AREA HAZARDOUS WASTE MANAGEMENT FACILITY (H-AREA INACTIVE PROCESS SEWER LINE 081-H)	Fourmile Branch	H	10-4 to 10-6	Complete	√	4	A.2, A.3	B.2
166	H-AREA BURNING PIT, NBN	Fourmile Branch	H	$< 10^{-6}$	Complete		5	A.1	

Table 4.3a*
RBES Planned End State By Area

*Data Consistantw/2004 PMP

Unit Index #	Unit Name	Watershed	Facility Area	FY03 Estimated Risk	Status	Institutional Controls in Place	Waste Unit Group (Hazard Type)	Soil Remedial Action	Groundwater Remedial Action (NA)
SRS unique identification waste unit number	Unit Name with facility or building number (NBN = no building number).	One of six SRS Watersheds where the unit resides.	Specific SRS geographic area unit resides.	Relative level of risk to a receptor from the unit, with $<10^{-6}$ being the lowest level and $>>10^{-4}$ being the greatest.	Status of unit in the regulatory cleanup process.	Units checked have SRS controls in place to restrict inappropriate uses of land or facilities when contaminants remain at the unit.	One of 11 generic hazard types used to categorize all SRS waste units. (Definitions in Appendix K.)	Remedial action in place for soils media. (Alpha numeric corresponds to actions defined in Appendix K; check mark denotes remedial action as yet to be determined.)	Remedial action in place for groundwater media. (Alpha numeric corresponds to actions defined in Appendix D; check mark denotes remedial action as yet to be determined.)
214	H-AREA EROSION CONTROL SITE, 080-25G	Fourmile Branch	H	$< 10^{-6}$	Complete		9	A.1	
285	H-AREA ACID/CAUSTIC BASIN (GROUNDWATER)	Fourmile Branch	H	$< 10^{-6}$	Complete		10	A.1	B.1
296	H-AREA SANITARY SLUDGE LAND APPLICATION SITE, NBN	Fourmile Branch	H	$< 10^{-6}$	Complete		7	A.1	
345	SANDBLAST AREA CMH-003, NBN	Fourmile Branch	H	$< 10^{-6}$	Complete		9	A.1	
348	SANDBLAST AREA CMH-004, NBN	Fourmile Branch	H	$< 10^{-6}$	Complete		9	A.1	
365	SPILL ON 01/01/80 OF 5600 LB OF 50% NITRIC ACID, NBN	Fourmile Branch	H	$< 10^{-6}$	Complete		9	A.1	
386	SPILL ON 11/24/89 OF 10 MCI OF CS - 137 FROM 254-8H, NBN	Fourmile Branch	H	$< 10^{-6}$	Complete		9	A.1	
357	SANDBLAST AREA CMS-001, NBN	Upper Three Runs	H	$< 10^{-6}$	Complete		9	A.1	
360	SPILL OF $<1/2$ LB MERCURY IN BLDG. 232-H, NBN	Upper Three Runs	H	$< 10^{-6}$	Complete		9	A.1	

Table 4.3a*
RBES Planned End State By Area

*Data Consistantw/2004 PMP

Unit Index #	Unit Name	Watershed	Facility Area	FY03 Estimated Risk	Status	Institutional Controls in Place	Waste Unit Group (Hazard Type)	Soil Remedial Action	Groundwater Remedial Action (NA)
SRS unique identification waste unit number	Unit Name with facility or building number (NBN = no building number).	One of six SRS Watersheds where the unit resides.	Specific SRS geographic area unit resides.	Relative level of risk to a receptor from the unit, with $<10^{-6}$ being the lowest level and $>>10^{-4}$ being the greatest.	Status of unit in the regulatory cleanup process.	Units checked have SRS controls in place to restrict inappropriate uses of land or facilities when contaminants remain at the unit.	One of 11 generic hazard types used to categorize all SRS waste units. (Definitions in Appendix K.)	Remedial action in place for soils media. (Alpha numeric corresponds to actions defined in Appendix K; check mark denotes remedial action as yet to be determined.)	Remedial action in place for groundwater media. (Alpha numeric corresponds to actions defined in Appendix D; check mark denotes remedial action as yet to be determined.)
364	SPILL ON 01/01/78 OF 600 LB OF 50% SODIUM HYDROXIDE, NBN	Upper Three Runs	H	$< 10^{-6}$	Complete		9	A.1	
433	SPILL ON 05/04/87 OF 30 GAL OF CAUSTIC FROM 295-H, NBN	Upper Three Runs	H	$< 10^{-6}$	Complete		9	A.1	
531	ECODS H-1 (WEST OF MAIN H-AREA FACILITIES)	Upper Three Runs	H	$< 10^{-6}$	Complete		5	A.1	
225	SPILL ON 02/01/57 OF UNKNOWN OF SEEPAGE BASIN PIPE LEAK FROM 904-44G, NBN	Fourmile Branch	H	10^{-4} to 10^{-6}	In Assessment Phase		9	√	
261	COMBINED SPILLS FROM 241-84H, NBN	Fourmile Branch	H	10^{-4} to 10^{-6}	In Assessment Phase		9	√	
262	COMBINED SPILLS FROM 241-H, NBN	Fourmile Branch	H	10^{-4} to 10^{-6}	In Assessment Phase		9	√	
264	COMBINED SPILLS FROM 242-H, NBN	Fourmile Branch	H	10^{-4} to 10^{-6}	In Assessment Phase		9	√	
274	DITCH TO OUTFALL H-13 (TRIBUTARY TO FOURMILE CREEK), NBN	Fourmile Branch	H	10^{-4} to 10^{-6}	In Assessment Phase		9	√	

Table 4.3a*
RBES Planned End State By Area

*Data Consistantw/2004 PMP

Unit Index #	Unit Name	Watershed	Facility Area	FY03 Estimated Risk	Status	Institutional Controls in Place	Waste Unit Group (Hazard Type)	Soil Remedial Action	Groundwater Remedial Action (NA)
SRS unique identification waste unit number	Unit Name with facility or building number (NBN = no building number).	One of six SRS Watersheds where the unit resides.	Specific SRS geographic area unit resides.	Relative level of risk to a receptor from the unit, with $<10^{-6}$ being the lowest level and $>>10^{-4}$ being the greatest.	Status of unit in the regulatory cleanup process.	Units checked have SRS controls in place to restrict inappropriate uses of land or facilities when contaminants remain at the unit.	One of 11 generic hazard types used to categorize all SRS waste units. (Definitions in Appendix K.)	Remedial action in place for soils media. (Alpha numeric corresponds to actions defined in Appendix K; check mark denotes remedial action as yet to be determined.)	Remedial action in place for groundwater media. (Alpha numeric corresponds to actions defined in Appendix D; check mark denotes remedial action as yet to be determined.)
275	DIVERSION BOX - RADIOACTIVITY FROM 907-1H, NBN	Fourmile Branch	H	10-4 to 10-6	In Assessment Phase		9	√	
292	H-AREA ASH BASIN, 288-0H	Fourmile Branch	H	10-4 to 10-6	In Assessment Phase		3	√	
293	H-AREA RETENTION BASIN, 281-08H	Fourmile Branch	H	> 10-4	In Assessment Phase		2	√	
294	H-AREA RETENTION BASIN, 281-1H	Fourmile Branch	H	> 10-4	In Assessment Phase		2	√	
295	H-AREA RETENTION BASIN, 281-2H	Fourmile Branch	H	> 10-4	In Assessment Phase		2	√	
298	H-AREA TANK FARM, 241-H	Fourmile Branch	H	>> 10-4	In Assessment Phase		2	√	
332	SPILL ON 10/07/85 OF 20,000 GALLONS OF CONTAMINATED WATER FROM 244-H, NBN	Fourmile Branch	H	10-4 to 10-6	In Assessment Phase		9	√	
375	SPILL ON 01/19/80 OF UNKNOWN OF CHROMATED WATER FROM H-AREA PUMP HOUSE, NBN	Fourmile Branch	H	10-4 to 10-6	In Assessment Phase		9	√	

Table 4.3a*
RBES Planned End State By Area

*Data Consistantw/2004 PMP

Unit Index #	Unit Name	Watershed	Facility Area	FY03 Estimated Risk	Status	Institutional Controls in Place	Waste Unit Group (Hazard Type)	Soil Remedial Action	Groundwater Remedial Action (NA)
SRS unique identification waste unit number	Unit Name with facility or building number (NBN = no building number).	One of six SRS Watersheds where the unit resides.	Specific SRS geographic area unit resides.	Relative level of risk to a receptor from the unit, with $<10^{-6}$ being the lowest level and $>>10^{-4}$ being the greatest.	Status of unit in the regulatory cleanup process.	Units checked have SRS controls in place to restrict inappropriate uses of land or facilities when contaminants remain at the unit.	One of 11 generic hazard types used to categorize all SRS waste units. (Definitions in Appendix K.)	Remedial action in place for soils media. (Alpha numeric corresponds to actions defined in Appendix K; check mark denotes remedial action as yet to be determined.)	Remedial action in place for groundwater media. (Alpha numeric corresponds to actions defined in Appendix D; check mark denotes remedial action as yet to be determined.)
383	SPILL ON 11/10/81 OF 500 GAL OF CHROMATED WATER FROM 243-H, NBN	Fourmile Branch	H	10-4 to 10-6	In Assessment Phase		9	√	
390	SPILL ON 02/01/69 OF UNKNOWN OF WASTE TANK SPILL, NBN	Fourmile Branch	H	10-4 to 10-6	In Assessment Phase		9	√	
403	SPILL ON 03/28/87 OF <15000 GAL OF CHROMATED WATER FROM 241-24H, NBN	Fourmile Branch	H	10-4 to 10-6	In Assessment Phase		9	√	
412	SPILL ON 04/18/80 OF UNKNOWN OF CHROMATED WATER FROM VALVE HOUSE 3, NBN	Fourmile Branch	H	10-4 to 10-6	In Assessment Phase		9	√	
423	SPILL ON 05/02/85 OF 10 GAL OF COOLING WATER FROM TANK FARM, NBN	Fourmile Branch	H	10-4 to 10-6	In Assessment Phase		9	√	
459	STORMWATER OUTFALL H-013, NBN	Fourmile Branch	H	10-4 to 10-6	In Assessment Phase		9	√	
554	H-AREA PROCESS SEWER LINES AS ABANDONED, NBN	Fourmile Branch	H	> 10-4	In Assessment Phase		4	√	
79	H-AREA COAL PILE RUNOFF BASIN, 289-H	Upper Three Runs	H	10-4 to 10-6	In Assessment Phase		3	√	

Table 4.3a*
RBES Planned End State By Area

***Data Consistantw/2004 PMP**

Unit Index #	Unit Name	Watershed	Facility Area	FY03 Estimated Risk	Status	Institutional Controls in Place	Waste Unit Group (Hazard Type)	Soil Remedial Action	Groundwater Remedial Action (NA)
SRS unique identification waste unit number	Unit Name with facility or building number (NBN = no building number).	One of six SRS Watersheds where the unit resides.	Specific SRS geographic area unit resides.	Relative level of risk to a receptor from the unit, with $<10^{-6}$ being the lowest level and $>>10^{-4}$ being the greatest.	Status of unit in the regulatory cleanup process.	Units checked have SRS controls in place to restrict inappropriate uses of land or facilities when contaminants remain at the unit.	One of 11 generic hazard types used to categorize all SRS waste units. (Definitions in Appendix K.)	Remedial action in place for soils media. (Alpha numeric corresponds to actions defined in Appendix K; check mark denotes remedial action as yet to be determined.)	Remedial action in place for groundwater media. (Alpha numeric corresponds to actions defined in Appendix D; check mark denotes remedial action as yet to be determined.)
142	H-AREA INACTIVE PROCESS SEWER LINES FROM BUILDING TO THE SECURITY FENCE, 081-H	Upper Three Runs	H	$> 10^{-4}$	In Assessment Phase		4	√	
260	COMBINED SPILLS FROM 211-H, NBN	Upper Three Runs	H	10^{-4} to 10^{-6}	In Assessment Phase		9	√	
344	SANDBLAST AREA CMH-001, NBN	Upper Three Runs	H	10^{-4} to 10^{-6}	In Assessment Phase		9	√	
346	SANDBLAST AREA CMH-002, NBN	Upper Three Runs	H	10^{-4} to 10^{-6}	In Assessment Phase		9	√	
374	SPILL ON 01/12/87 OF <100 GM OF MERCURY NORTH OF 211-H, NBN	Upper Three Runs	H	10^{-4} to 10^{-6}	In Assessment Phase		9	√	
391	SPILL ON 02/01/83 OF 50 GAL OF OIL - RAD, NBN	Upper Three Runs	H	10^{-4} to 10^{-6}	In Assessment Phase		9	√	
512	COMBINED SPILLS FROM 221-H, NBN	Upper Three Runs	H	10^{-4} to 10^{-6}	In Assessment Phase		9	√	
27	WARNER'S POND, 685-23G	Fourmile Branch	H	$> 10^{-4}$	In Remediation		2	√	
28	H-AREA RETENTION BASIN, 281-3H	Fourmile Branch	H	$> 10^{-4}$	In Remediation		2	√	

Table 4.3a*
RBES Planned End State By Area

*Data Consistantw/2004 PMP

Unit Index #	Unit Name	Watershed	Facility Area	FY03 Estimated Risk	Status	Institutional Controls in Place	Waste Unit Group (Hazard Type)	Soil Remedial Action	Groundwater Remedial Action (NA)
SRS unique identification waste unit number	Unit Name with facility or building number (NBN = no building number).	One of six SRS Watersheds where the unit resides.	Specific SRS geographic area unit resides.	Relative level of risk to a receptor from the unit, with $<10^{-6}$ being the lowest level and $>>10^{-4}$ being the greatest.	Status of unit in the regulatory cleanup process.	Units checked have SRS controls in place to restrict inappropriate uses of land or facilities when contaminants remain at the unit.	One of 11 generic hazard types used to categorize all SRS waste units. (Definitions in Appendix K.)	Remedial action in place for soils media. (Alpha numeric corresponds to actions defined in Appendix K; check mark denotes remedial action as yet to be determined.)	Remedial action in place for groundwater media. (Alpha numeric corresponds to actions defined in Appendix D; check mark denotes remedial action as yet to be determined.)
29	HP-52 PONDS, NBN	Fourmile Branch	H	$> 10^{-4}$	In Remediation		2	√	
398	SPILL ON 02/08/78 OF UNKNOWN OF H-AREA PROCESS SEWER LINE CAVE-IN, NBN	Fourmile Branch	H	10^{-4} to 10^{-6}	In Remediation		9	√	
405	SPILL ON 03/08/78 OF UNKNOWN OF SEEPAGE BASIN PIPE LEAK IN H-AREA SEEPAGE BASIN	Fourmile Branch	H	10^{-4} to 10^{-6}	In Remediation		9	√	
417	SPILL ON 05/01/56 OF UNKNOWN OF RETENTION BASIN PIPE LEAK, NBN	Fourmile Branch	H	10^{-4} to 10^{-6}	In Remediation		9	√	
549	GENERAL SEPARATIONS AREA EASTERN GROUNDWATER OPERABLE UNIT, NBN	Upper Three Runs	H	$> 10^{-4}$	In Remediation		10		√
11	K-AREA ACID/CAUSTIC BASIN, 904-80G	Pen Branch	K	$< 10^{-6}$	Complete		8	A.1, A.3	B.1
83	K-AREA BINGHAM PUMP OUTAGE PIT, 643-1G	Pen Branch	K	10^{-4} to 10^{-6}	Complete	√	2	A.2	

Table 4.3a*
RBES Planned End State By Area

***Data Consistantw/2004 PMP**

Unit Index #	Unit Name	Watershed	Facility Area	FY03 Estimated Risk	Status	Institutional Controls in Place	Waste Unit Group (Hazard Type)	Soil Remedial Action	Groundwater Remedial Action (NA)
SRS unique identification waste unit number	Unit Name with facility or building number (NBN = no building number).	One of six SRS Watersheds where the unit resides.	Specific SRS geographic area unit resides.	Relative level of risk to a receptor from the unit, with $<10^{-6}$ being the lowest level and $>>10^{-4}$ being the greatest.	Status of unit in the regulatory cleanup process.	Units checked have SRS controls in place to restrict inappropriate uses of land or facilities when contaminants remain at the unit.	One of 11 generic hazard types used to categorize all SRS waste units. (Definitions in Appendix K.)	Remedial action in place for soils media. (Alpha numeric corresponds to actions defined in Appendix K; check mark denotes remedial action as yet to be determined.)	Remedial action in place for groundwater media. (Alpha numeric corresponds to actions defined in Appendix D; check mark denotes remedial action as yet to be determined.)
84	K-AREA BURNING/RUBBLE PIT, 131-K	Pen Branch	K	10-4 to 10-6	Complete	√	5	A.2, A.3	B.2, B.3
85	K-AREA COAL PILE RUNOFF BASIN, 189-K	Pen Branch	K	10-4 to 10-6	Complete	√	3	A.2, A.3	B.2
87	K-AREA REACTOR SEEPAGE BASIN, 904-65G	Pen Branch	K	10-4 to 10-6	Complete	√	2	A.2, A.3, A.4, A.7	
88	K-AREA RUBBLE PILE, 631-20G	Pen Branch	K	10-4 to 10-6	Complete	√	5	A.2, A.3	B.2
191	K-AREA SANDBLAST AREA CMK-001	Pen Branch	K	$< 10^{-6}$	Complete		9	A.1	
222	SPILL ON 01/01/57 OF <1 CI OF BETA - GAMMA, NBN	Pen Branch	K	$< 10^{-6}$	Complete		9	A.1	
258	COMBINED SPILLS FROM 183-2K, NBN	Pen Branch	K	$< 10^{-6}$	Complete		9	A.1	
286	K-AREA ACID/CAUSTIC BASIN (GROUNDWATER)	Pen Branch	K	$< 10^{-6}$	Complete		10	A.1	B.1
299	K-AREA AREA OF CONCERN, NBN	Pen Branch	K	$< 10^{-6}$	Complete		9	A.1	

Table 4.3a*
RBES Planned End State By Area

*Data Consistantw/2004 PMP

Unit Index #	Unit Name	Watershed	Facility Area	FY03 Estimated Risk	Status	Institutional Controls in Place	Waste Unit Group (Hazard Type)	Soil Remedial Action	Groundwater Remedial Action (NA)
SRS unique identification waste unit number	Unit Name with facility or building number (NBN = no building number).	One of six SRS Watersheds where the unit resides.	Specific SRS geographic area unit resides.	Relative level of risk to a receptor from the unit, with $<10^{-6}$ being the lowest level and $>>10^{-4}$ being the greatest.	Status of unit in the regulatory cleanup process.	Units checked have SRS controls in place to restrict inappropriate uses of land or facilities when contaminants remain at the unit.	One of 11 generic hazard types used to categorize all SRS waste units. (Definitions in Appendix K.)	Remedial action in place for soils media. (Alpha numeric corresponds to actions defined in Appendix K; check mark denotes remedial action as yet to be determined.)	Remedial action in place for groundwater media. (Alpha numeric corresponds to actions defined in Appendix D; check mark denotes remedial action as yet to be determined.)
341	SANDBLAST AREA CMK-002, NBN	Pen Branch	K	$< 10^{-6}$	Complete		9	A.1	
342	SANDBLAST AREA CMK-003, NBN	Pen Branch	K	$< 10^{-6}$	Complete		9	A.1	
378	SPILL ON 01/29/86 OF <5 GAL OF WATER - RAD FROM 106-1C, NBN	Pen Branch	K	$< 10^{-6}$	Complete		9	A.1	
413	SPILL ON 04/23/82 OF 4800 GAL OF ACID SOLUTION, NBN	Pen Branch	K	$< 10^{-6}$	Complete		9	A.1	
532	ECODS K-1 (SOUTHEAST OF FORMER LAYDOWN YARD AT K AREA)	Pen Branch	K	$< 10^{-6}$	Complete		5	A.1	
533	ECODS K-2 (NORTHWEST OF K AREA FACILITIES)	Pen Branch	K	$< 10^{-6}$	Complete		5	A.1	
534	ECODS K-3 (SOUTHEAST OF K AREA IN FORMER LAYDOWN YARD)	Pen Branch	K	$< 10^{-6}$	Complete		5	A.1	

Table 4.3a*
RBES Planned End State By Area

***Data Consistantw/2004 PMP**

Unit Index #	Unit Name	Watershed	Facility Area	FY03 Estimated Risk	Status	Institutional Controls in Place	Waste Unit Group (Hazard Type)	Soil Remedial Action	Groundwater Remedial Action (NA)
SRS unique identification waste unit number	Unit Name with facility or building number (NBN = no building number).	One of six SRS Watersheds where the unit resides.	Specific SRS geographic area unit resides.	Relative level of risk to a receptor from the unit, with $<10^{-6}$ being the lowest level and $>>10^{-4}$ being the greatest.	Status of unit in the regulatory cleanup process.	Units checked have SRS controls in place to restrict inappropriate uses of land or facilities when contaminants remain at the unit.	One of 11 generic hazard types used to categorize all SRS waste units. (Definitions in Appendix K.)	Remedial action in place for soils media. (Alpha numeric corresponds to actions defined in Appendix K; check mark denotes remedial action as yet to be determined.)	Remedial action in place for groundwater media. (Alpha numeric corresponds to actions defined in Appendix D; check mark denotes remedial action as yet to be determined.)
89	K-AREA SLUDGE LAND APPLICATION SITE, 761-4G	Pen Branch	K	10-4 to 10-6	In Assessment Phase		7	√	
300	K-AREA ASH BASIN, 188-0K	Pen Branch	K	10-4 to 10-6	In Assessment Phase		3	√	
301	K-AREA DISASSEMBLY BASIN, 105-K	Pen Branch	K	$> 10^{-4}$	In Assessment Phase		2	√	
302	K-AREA REACTOR COOLING WATER SYSTEM, 186/190-K	Pen Branch	K	10-4 to 10-6	In Assessment Phase		2	√	
460	K-AREA REACTOR DISCHARGE CANAL, NBN	Pen Branch	K	$> 10^{-4}$	In Assessment Phase		2	√	
476	K REACTOR AREA: K-AREA REACTOR AREA CASK CAR RAILROAD TRACKS AS ABANDONED, NBN	Pen Branch	K	$> 10^{-4}$	In Assessment Phase		5	√	
514	COMBINED SPILLS FROM 105-K, 106-K, AND 109-K, NBN	Pen Branch	K	10-4 to 10-6	In Assessment Phase		9	√	
519	K-AREA REACTOR GROUNDWATER (INCLUDING TRITIUM	Pen Branch	K	$> 10^{-4}$	In Assessment Phase		10		√

Table 4.3a*
RBES Planned End State By Area

*Data Consistantw/2004 PMP

Unit Index #	Unit Name	Watershed	Facility Area	FY03 Estimated Risk	Status	Institutional Controls in Place	Waste Unit Group (Hazard Type)	Soil Remedial Action	Groundwater Remedial Action (NA)
SRS unique identification waste unit number	Unit Name with facility or building number (NBN = no building number).	One of six SRS Watersheds where the unit resides.	Specific SRS geographic area unit resides.	Relative level of risk to a receptor from the unit, with $<10^{-6}$ being the lowest level and $>>10^{-4}$ being the greatest.	Status of unit in the regulatory cleanup process.	Units checked have SRS controls in place to restrict inappropriate uses of land or facilities when contaminants remain at the unit.	One of 11 generic hazard types used to categorize all SRS waste units. (Definitions in Appendix K.)	Remedial action in place for soils media. (Alpha numeric corresponds to actions defined in Appendix K; check mark denotes remedial action as yet to be determined.)	Remedial action in place for groundwater media. (Alpha numeric corresponds to actions defined in Appendix D; check mark denotes remedial action as yet to be determined.)
	ANOMALY)								
78	GAS CYLINDER DISPOSAL FACILITY, 131-2L	Pen Branch	L	$< 10^{-6}$	Complete		5	A.1, A.7	
91	L-AREA BINGHAM PUMP OUTAGE PITS, 643-2G	Pen Branch	L	10-4 to 10-6	Complete	√	2	A.2	B.1
92	L-AREA BINGHAM PUMP OUTAGE PITS, 643-3G	Pen Branch	L	10-4 to 10-6	Complete	√	2	A.2	B.1
93	L-AREA BURNING/RUBBLE PIT, 131-L	Pen Branch	L	10-4 to 10-6	Complete	√	5	A.2, A.3, A.7	B.2, B.3
97	L-AREA RUBBLE PILE, 631-26G	Pen Branch	L	10-4 to 10-6	Complete	√	5	A.2, A.3, A.7	B.2, B.3
304	L-AREA EROSION CONTROL SITE, 080-26G	Pen Branch	L	$< 10^{-6}$	Complete		9	A.1	
169	L-AREA RUBBLE PILE, 131-3L	Pen Branch	L	10-4 to 10-6	Complete	√	5	√	

Table 4.3a*
RBES Planned End State By Area

*Data Consistantw/2004 PMP

Unit Index #	Unit Name	Watershed	Facility Area	FY03 Estimated Risk	Status	Institutional Controls in Place	Waste Unit Group (Hazard Type)	Soil Remedial Action	Groundwater Remedial Action (NA)
SRS unique identification waste unit number	Unit Name with facility or building number (NBN = no building number).	One of six SRS Watersheds where the unit resides.	Specific SRS geographic area unit resides.	Relative level of risk to a receptor from the unit, with $<10^{-6}$ being the lowest level and $>>10^{-4}$ being the greatest.	Status of unit in the regulatory cleanup process.	Units checked have SRS controls in place to restrict inappropriate uses of land or facilities when contaminants remain at the unit.	One of 11 generic hazard types used to categorize all SRS waste units. (Definitions in Appendix K.)	Remedial action in place for soils media. (Alpha numeric corresponds to actions defined in Appendix K; check mark denotes remedial action as yet to be determined.)	Remedial action in place for groundwater media. (Alpha numeric corresponds to actions defined in Appendix D; check mark denotes remedial action as yet to be determined.)
95	L-AREA ACID/CAUSTIC BASIN, 904-79G	Steel Creek	L	$< 10^{-6}$	Complete		8	A.1, A.3	B.1
96	L-AREA OIL/CHEMICAL BASIN, 904-83G	Steel Creek	L	10-4 to 10-6	Complete	√	2	A.2, A.3, A.4	
170	L-AREA SCRAP METAL AND WOOD, NBN	Steel Creek	L	$< 10^{-6}$	Complete		5	A.1	
176	PILE OF TELEPHONE/LIGHT POLES, NBN	Steel Creek	L	$< 10^{-6}$	Complete		5	A.1	
306	L-AREA REACTOR SEEPAGE BASIN, 904-064G	Steel Creek	L	10-4 to 10-6	Complete	√	2	A.2, A.3	
323	POTENTIAL RELEASE OF NAOH/H2 SO4 FROM 183-2L, NBN	Steel Creek	L	$< 10^{-6}$	Complete		9	A.1	
495	SANDBLAST AREA CML-001, NBN	Steel Creek	L	$< 10^{-6}$	Complete		9	A.1	
496	SANDBLAST AREA CML-002, NBN	Steel Creek	L	$< 10^{-6}$	Complete		9	A.1	

Table 4.3a*
RBES Planned End State By Area

***Data Consistantw/2004 PMP**

Unit Index #	Unit Name	Watershed	Facility Area	FY03 Estimated Risk	Status	Institutional Controls in Place	Waste Unit Group (Hazard Type)	Soil Remedial Action	Groundwater Remedial Action (NA)
SRS unique identification waste unit number	Unit Name with facility or building number (NBN = no building number).	One of six SRS Watersheds where the unit resides.	Specific SRS geographic area unit resides.	Relative level of risk to a receptor from the unit, with $<10^{-6}$ being the lowest level and $>>10^{-4}$ being the greatest.	Status of unit in the regulatory cleanup process.	Units checked have SRS controls in place to restrict inappropriate uses of land or facilities when contaminants remain at the unit.	One of 11 generic hazard types used to categorize all SRS waste units. (Definitions in Appendix K.)	Remedial action in place for soils media. (Alpha numeric corresponds to actions defined in Appendix K; check mark denotes remedial action as yet to be determined.)	Remedial action in place for groundwater media. (Alpha numeric corresponds to actions defined in Appendix D; check mark denotes remedial action as yet to be determined.)
535	ECODS L-1 (EAST OF L AREA)	Steel Creek	L	$< 10^{-6}$	Complete		5	A.1	
536	ECODS L-2 (EAST OF L AREA)	Steel Creek	L	10^{-4} to 10^{-6}	Complete		5	A.1	
148	L-AREA ASH BASIN 188-0L	Pen Branch	L	10^{-4} to 10^{-6}	In Assessment Phase		3	√	
98	L-AREA RUBBLE PIT, 131-1L	Steel Creek	L	$< 10^{-6}$	In Assessment Phase		5	A.1	
99	L-AREA RUBBLE PIT, 131-4L	Steel Creek	L	10^{-4} to 10^{-6}	In Assessment Phase		5	√	
303	L-AREA DISASSEMBLY BASIN, 105-L	Steel Creek	L	10^{-4} to 10^{-6}	In Assessment Phase		2	√	
305	L-AREA REACTOR COOLING WATER SYSTEM, 186/190-L	Steel Creek	L	10^{-4} to 10^{-6}	In Assessment Phase		2	√	
452	SPILL ON 09/21/84 OF 200 GAL OF WATER - RAD, NBN	Steel Creek	L	10^{-4} to 10^{-6}	In Assessment Phase		9	√	
479	L REACTOR AREA: L-AREA REACTOR AREA CASK CAR RAILROAD	Steel Creek	L	$> 10^{-4}$	In Assessment Phase		5	√	

Table 4.3a*
RBES Planned End State By Area

*Data Consistantw/2004 PMP

Unit Index #	Unit Name	Watershed	Facility Area	FY03 Estimated Risk	Status	Institutional Controls in Place	Waste Unit Group (Hazard Type)	Soil Remedial Action	Groundwater Remedial Action (NA)
SRS unique identification waste unit number	Unit Name with facility or building number (NBN = no building number).	One of six SRS Watersheds where the unit resides.	Specific SRS geographic area unit resides.	Relative level of risk to a receptor from the unit, with $<10^{-6}$ being the lowest level and $>>10^{-4}$ being the greatest.	Status of unit in the regulatory cleanup process.	Units checked have SRS controls in place to restrict inappropriate uses of land or facilities when contaminants remain at the unit.	One of 11 generic hazard types used to categorize all SRS waste units. (Definitions in Appendix K.)	Remedial action in place for soils media. (Alpha numeric corresponds to actions defined in Appendix K; check mark denotes remedial action as yet to be determined.)	Remedial action in place for groundwater media. (Alpha numeric corresponds to actions defined in Appendix D; check mark denotes remedial action as yet to be determined.)
	TRACKS AS ABANDONED, NBN								
487	L-AREA SOUTHERN GROUNDWATER, NBN	Steel Creek	L	$> 10^{-4}$	In Assessment Phase		10		√
503	L-AREA NORTHERN GROUNDWATER	Steel Creek	L	10^{-4} to 10^{-6}	In Assessment Phase		10		√
537	ECODS L-3 (EAST OF L AREA)	Steel Creek	L	10^{-4} to 10^{-6}	In Assessment Phase		5	√	
94	L-AREA HOT SHOP (INCLUDING SANDBLAST AREA CML-003, NBN), 717-G	Steel Creek	L	$> 10^{-4}$	In Remediation		9	√	
12	M-AREA HAZARDOUS WASTE MANAGEMENT FACILITY (LOST LAKE)	Savannah River / Floodplain / Swamp	M	10^{-4} to 10^{-6}	Complete	√	9	A.2, A.7	
13	M-AREA HAZARDOUS WASTE MANAGEMENT FACILITY (M-AREA SETTLING BASIN, 904-51G)	Savannah River / Floodplain / Swamp	M	10^{-4} to 10^{-6}	Complete	√	2	A.2, A.3, A.4	B.5, B.9
14	M-AREA WEST, 631-21G	Savannah River / Floodplain / Swamp	M	$< 10^{-6}$	Complete		5	A.1	

Table 4.3a*
RBES Planned End State By Area

*Data Consistantw/2004 PMP

Unit Index #	Unit Name	Watershed	Facility Area	FY03 Estimated Risk	Status	Institutional Controls in Place	Waste Unit Group (Hazard Type)	Soil Remedial Action	Groundwater Remedial Action (NA)
SRS unique identification waste unit number	Unit Name with facility or building number (NBN = no building number).	One of six SRS Watersheds where the unit resides.	Specific SRS geographic area unit resides.	Relative level of risk to a receptor from the unit, with $<10^{-6}$ being the lowest level and $>>10^{-4}$ being the greatest.	Status of unit in the regulatory cleanup process.	Units checked have SRS controls in place to restrict inappropriate uses of land or facilities when contaminants remain at the unit.	One of 11 generic hazard types used to categorize all SRS waste units. (Definitions in Appendix K.)	Remedial action in place for soils media. (Alpha numeric corresponds to actions defined in Appendix K; check mark denotes remedial action as yet to be determined.)	Remedial action in place for groundwater media. (Alpha numeric corresponds to actions defined in Appendix D; check mark denotes remedial action as yet to be determined.)
187	M-AREA SANDBLAST AREA CMM-006	Savannah River / Floodplain / Swamp	M	< 10-6	Complete		9	A.1	
188	M-AREA SANDBLAST AREA CMM-007	Savannah River / Floodplain / Swamp	M	< 10-6	Complete		9	A.1	
189	M-AREA SANDBLAST AREA CMM-004	Savannah River / Floodplain / Swamp	M	< 10-6	Complete		9	A.1	
190	M-AREA SANDBLAST AREA CMM-005	Savannah River / Floodplain / Swamp	M	< 10-6	Complete		9	A.1	
193	SILVERTON ROAD WASTE TANK PLUGS, NBN	Savannah River / Floodplain / Swamp	M	< 10-6	Complete		5	A.1	
196	SPILL ON 03/30/87 OF 15 GAL OF ACIDIC WATER, NBN	Savannah River / Floodplain / Swamp	M	< 10-6	Complete		9	A.1	
197	SPILL ON 03/30/88 OF 15 GAL OF ACIDIC WATER, NBN	Savannah River / Floodplain / Swamp	M	< 10-6	Complete		9	A.1	
215	POTENTIAL RELEASE OF CAUSTIC/HNO3 FROM 312-M, NBN	Savannah River / Floodplain / Swamp	M	< 10-6	Complete		9	A.1	

Table 4.3a*
RBES Planned End State By Area

***Data Consistantw/2004 PMP**

Unit Index #	Unit Name	Watershed	Facility Area	FY03 Estimated Risk	Status	Institutional Controls in Place	Waste Unit Group (Hazard Type)	Soil Remedial Action	Groundwater Remedial Action (NA)
SRS unique identification waste unit number	Unit Name with facility or building number (NBN = no building number).	One of six SRS Watersheds where the unit resides.	Specific SRS geographic area unit resides.	Relative level of risk to a receptor from the unit, with $<10^{-6}$ being the lowest level and $>>10^{-4}$ being the greatest.	Status of unit in the regulatory cleanup process.	Units checked have SRS controls in place to restrict inappropriate uses of land or facilities when contaminants remain at the unit.	One of 11 generic hazard types used to categorize all SRS waste units. (Definitions in Appendix K.)	Remedial action in place for soils media. (Alpha numeric corresponds to actions defined in Appendix K; check mark denotes remedial action as yet to be determined.)	Remedial action in place for groundwater media. (Alpha numeric corresponds to actions defined in Appendix D; check mark denotes remedial action as yet to be determined.)
224	SPILL ON 10/07/85 OF 1 GAL OF NITRIC ACID AT BARRICADE 10, NBN	Savannah River / Floodplain / Swamp	M	$< 10^{-6}$	Complete		9	A.1	
322	POTENTIAL RELEASE OF DIESEL FUEL AND BENZENE FROM 730-M, NBN	Savannah River / Floodplain / Swamp	M	$< 10^{-6}$	Complete		9	A.1	
347	SANDBLAST AREA CMM-002, NBN	Savannah River / Floodplain / Swamp	M	$< 10^{-6}$	Complete		9	A.1	
352	SANDBLAST AREA CMM-008, NBN	Savannah River / Floodplain / Swamp	M	$< 10^{-6}$	Complete		9	A.1	
369	SPILL ON 01/01/85 OF 3 GAL OF ALUMINUM NITRATE, NBN	Savannah River / Floodplain / Swamp	M	$< 10^{-6}$	Complete		9	A.1	
371	SPILL ON 01/01/87 OF 5 GAL OF 50% SODIUM HYDROXIDE, NBN	Savannah River / Floodplain / Swamp	M	$< 10^{-6}$	Complete		9	A.1	
377	SPILL ON 01/19/86 OF UNKNOWN OF PLATING SOLUTION, NBN	Savannah River / Floodplain / Swamp	M	$< 10^{-6}$	Complete		9	A.1	
379	SPILL ON 01/07/87 OF 20 GAL OF CAUSTIC, NBN	Savannah River / Floodplain / Swamp	M	$< 10^{-6}$	Complete		9	A.1	

Table 4.3a*
RBES Planned End State By Area

***Data Consistantw/2004 PMP**

Unit Index #	Unit Name	Watershed	Facility Area	FY03 Estimated Risk	Status	Institutional Controls in Place	Waste Unit Group (Hazard Type)	Soil Remedial Action	Groundwater Remedial Action (NA)
SRS unique identification waste unit number	Unit Name with facility or building number (NBN = no building number).	One of six SRS Watersheds where the unit resides.	Specific SRS geographic area unit resides.	Relative level of risk to a receptor from the unit, with $<10^{-6}$ being the lowest level and $>>10^{-4}$ being the greatest.	Status of unit in the regulatory cleanup process.	Units checked have SRS controls in place to restrict inappropriate uses of land or facilities when contaminants remain at the unit.	One of 11 generic hazard types used to categorize all SRS waste units. (Definitions in Appendix K.)	Remedial action in place for soils media. (Alpha numeric corresponds to actions defined in Appendix K; check mark denotes remedial action as yet to be determined.)	Remedial action in place for groundwater media. (Alpha numeric corresponds to actions defined in Appendix D; check mark denotes remedial action as yet to be determined.)
388	SPILL ON 12/17/85 OF 2 GAL OF PHOSPHORIC ACID, NBN	Savannah River / Floodplain / Swamp	M	$< 10^{-6}$	Complete		9	A.1	
397	SPILL ON 02/06/85 OF 50 GAL OF CAUSTIC, NBN	Savannah River / Floodplain / Swamp	M	$< 10^{-6}$	Complete		9	A.1	
400	SPILL ON 03/11/87 OF 1 GAL OF CAUSTIC, NBN	Savannah River / Floodplain / Swamp	M	$< 10^{-6}$	Complete		9	A.1	
404	SPILL ON 03/07/86 OF 10 GAL OF ACID, NBN	Savannah River / Floodplain / Swamp	M	$< 10^{-6}$	Complete		9	A.1	
406	SPILL ON 03/08/86 OF 1/2 PINT OF WATER - RAD, NBN	Savannah River / Floodplain / Swamp	M	$< 10^{-6}$	Complete		9	A.1	
407	SPILL ON 03/08/86 OF 10 GAL OF NITRIC ACID, NBN	Savannah River / Floodplain / Swamp	M	$< 10^{-6}$	Complete		9	A.1	
408	SPILL ON 03/08/86 OF 6 GAL OF CAUSTIC, NBN	Savannah River / Floodplain / Swamp	M	$< 10^{-6}$	Complete		9	A.1	
415	SPILL ON 04/25/87 OF 15 GAL OF WATER - RAD, NBN	Savannah River / Floodplain / Swamp	M	$< 10^{-6}$	Complete		9	A.1	
420	SPILL ON 05/01/87 OF 100 GAL OF WATER FROM 300-M, NBN	Savannah River / Floodplain / Swamp	M	$< 10^{-6}$	Complete		9	A.1	

Table 4.3a*
RBES Planned End State By Area

*Data Consistantw/2004 PMP

Unit Index #	Unit Name	Watershed	Facility Area	FY03 Estimated Risk	Status	Institutional Controls in Place	Waste Unit Group (Hazard Type)	Soil Remedial Action	Groundwater Remedial Action (NA)
SRS unique identification waste unit number	Unit Name with facility or building number (NBN = no building number).	One of six SRS Watersheds where the unit resides.	Specific SRS geographic area unit resides.	Relative level of risk to a receptor from the unit, with $<10^{-6}$ being the lowest level and $>>10^{-4}$ being the greatest.	Status of unit in the regulatory cleanup process.	Units checked have SRS controls in place to restrict inappropriate uses of land or facilities when contaminants remain at the unit.	One of 11 generic hazard types used to categorize all SRS waste units. (Definitions in Appendix K.)	Remedial action in place for soils media. (Alpha numeric corresponds to actions defined in Appendix K; check mark denotes remedial action as yet to be determined.)	Remedial action in place for groundwater media. (Alpha numeric corresponds to actions defined in Appendix D; check mark denotes remedial action as yet to be determined.)
440	SPILL ON 06/28/84 OF 100 GAL OF CHILLED WATER, NBN	Savannah River / Floodplain / Swamp	M	$< 10^{-6}$	Complete		9	A.1	
446	SPILL ON 08/18/86 OF 20 GAL OF WATER - RAD, NBN	Savannah River / Floodplain / Swamp	M	$< 10^{-6}$	Complete		9	A.1	
447	SPILL ON 08/29/85 OF 500 GM OF URANYL NITRATE, NBN	Savannah River / Floodplain / Swamp	M	$< 10^{-6}$	Complete		9	A.1	
450	SPILL ON 09/10/86 OF 1 GAL OF WATER - RAD, NBN	Savannah River / Floodplain / Swamp	M	$< 10^{-6}$	Complete		9	A.1	
451	SPILL ON 09/20/87 OF UNKNOWN AMOUNT OF WATER - RAD, NBN	Savannah River / Floodplain / Swamp	M	$< 10^{-6}$	Complete		9	A.1	
454	SPILL ON 09/04/85 OF 1 1/2 GAL OF NITRIC ACID, NBN	Savannah River / Floodplain / Swamp	M	$< 10^{-6}$	Complete		9	A.1	

Table 4.3a*
RBES Planned End State By Area

***Data Consistantw/2004 PMP**

Unit Index #	Unit Name	Watershed	Facility Area	FY03 Estimated Risk	Status	Institutional Controls in Place	Waste Unit Group (Hazard Type)	Soil Remedial Action	Groundwater Remedial Action (NA)
SRS unique identification waste unit number	Unit Name with facility or building number (NBN = no building number).	One of six SRS Watersheds where the unit resides.	Specific SRS geographic area unit resides.	Relative level of risk to a receptor from the unit, with $<10^{-6}$ being the lowest level and $>>10^{-4}$ being the greatest.	Status of unit in the regulatory cleanup process.	Units checked have SRS controls in place to restrict inappropriate uses of land or facilities when contaminants remain at the unit.	One of 11 generic hazard types used to categorize all SRS waste units. (Definitions in Appendix K.)	Remedial action in place for soils media. (Alpha numeric corresponds to actions defined in Appendix K; check mark denotes remedial action as yet to be determined.)	Remedial action in place for groundwater media. (Alpha numeric corresponds to actions defined in Appendix D; check mark denotes remedial action as yet to be determined.)
464	UN-NUMBERED GUN EMPLACEMENT RUBBLE PILE, NBN	Savannah River / Floodplain / Swamp	M	$< 10^{-6}$	Complete		9	A.1	
486	CONTAMINATED SOIL, 321-M	Savannah River / Floodplain / Swamp	M	$< 10^{-6}$	Complete		9	A.1	
15	METALLURGICAL LABORATORY HAZARDOUS MANAGEMENT FACILITY, 904-110G	Upper Three Runs	M	10-4 to 10-6	Complete	√	5	A.2, A.3	B.5, B.9
56	M-AREA HAZARDOUS WASTE MANAGEMENT FACILITY (CAROLINA BAY)	Upper Three Runs	M	10-4 to 10-6	Complete	√	9	A.2	
195	SPILL ON 03/20/86 OF <1 GAL OF WATER - RAD, NBN	Upper Three Runs	M	$< 10^{-6}$	Complete		9	A.1	
198	SPILL ON 03/04/86 OF 5 GAL OF 50% NAOH FROM 341-M, NBN	Upper Three Runs	M	$< 10^{-6}$	Complete		9	A.1	
409	SPILL ON 04/01/85 OF 25 ML OF SULFURIC ACID, NBN	Upper Three Runs	M	$< 10^{-6}$	Complete		9	A.1	

Table 4.3a*
RBES Planned End State By Area

***Data Consistantw/2004 PMP**

Unit Index #	Unit Name	Watershed	Facility Area	FY03 Estimated Risk	Status	Institutional Controls in Place	Waste Unit Group (Hazard Type)	Soil Remedial Action	Groundwater Remedial Action (NA)
SRS unique identification waste unit number	Unit Name with facility or building number (NBN = no building number).	One of six SRS Watersheds where the unit resides.	Specific SRS geographic area unit resides.	Relative level of risk to a receptor from the unit, with $<10^{-6}$ being the lowest level and $>>10^{-4}$ being the greatest.	Status of unit in the regulatory cleanup process.	Units checked have SRS controls in place to restrict inappropriate uses of land or facilities when contaminants remain at the unit.	One of 11 generic hazard types used to categorize all SRS waste units. (Definitions in Appendix K.)	Remedial action in place for soils media. (Alpha numeric corresponds to actions defined in Appendix K; check mark denotes remedial action as yet to be determined.)	Remedial action in place for groundwater media. (Alpha numeric corresponds to actions defined in Appendix D; check mark denotes remedial action as yet to be determined.)
410	SPILL ON 04/01/87 OF <5 GAL OF CR III LIGNO - SULFONATE, NBN	Upper Three Runs	M	$< 10^{-6}$	Complete		9	A.1	
480	SANDBLAST AREA CMM-003, NBN	Upper Three Runs	M	$< 10^{-6}$	Complete		9	A.1	
484	M-AREA HAZARDOUS WASTE MANAGEMENT FACILITY: M-AREA VADOSE ZONE, 643-28G	Upper Three Runs	M	$< 10^{-6}$	Complete		2		B.5
497	SANDBLAST AREA CMM-001, NBN	Upper Three Runs	M	$< 10^{-6}$	Complete		9	A.1	
100	M-AREA SETTLING BASIN INACTIVE PROCESS SEWERS TO MANHOLE 1, 081-M	Savannah River / Floodplain / Swamp	M	$> 10^{-4}$	In Assessment Phase		4	√	√
326	POTENTIAL RELEASE OF TCT, TET TCE, HNO ₃ , U, HEAVY METALS FROM 321-M ABANDONED SEWER LINE, NBN	Savannah River / Floodplain / Swamp	M	10 ⁻⁴ to 10 ⁻⁶	In Assessment Phase		4	√	√
465	UNDERGROUND SUMP 321 M #001 321-M	Savannah River / Floodplain / Swamp	M	$> 10^{-4}$	In Assessment Phase		4	√	

Table 4.3a*
RBES Planned End State By Area

*Data Consistantw/2004 PMP

Unit Index #	Unit Name	Watershed	Facility Area	FY03 Estimated Risk	Status	Institutional Controls in Place	Waste Unit Group (Hazard Type)	Soil Remedial Action	Groundwater Remedial Action (NA)
SRS unique identification waste unit number	Unit Name with facility or building number (NBN = no building number).	One of six SRS Watersheds where the unit resides.	Specific SRS geographic area unit resides.	Relative level of risk to a receptor from the unit, with $<10^{-6}$ being the lowest level and $>>10^{-4}$ being the greatest.	Status of unit in the regulatory cleanup process.	Units checked have SRS controls in place to restrict inappropriate uses of land or facilities when contaminants remain at the unit.	One of 11 generic hazard types used to categorize all SRS waste units. (Definitions in Appendix K.)	Remedial action in place for soils media. (Alpha numeric corresponds to actions defined in Appendix K; check mark denotes remedial action as yet to be determined.)	Remedial action in place for groundwater media. (Alpha numeric corresponds to actions defined in Appendix D; check mark denotes remedial action as yet to be determined.)
466	UNDERGROUND SUMP 321 M #002 321-M	Savannah River / Floodplain / Swamp	M	$> 10^{-4}$	In Assessment Phase		4	√	
234	313-M AND 320-M INACTIVE CLAY PROCESS SEWERS TO TIMS BRANCH, NBN	Upper Three Runs	M	$> 10^{-4}$	In Assessment Phase		4	√	√
23	M-AREA HAZARDOUS WASTE MANAGEMENT FACILITY: A/M AREA GROUNDWATER PORTION, 904-110G	Upper Three Runs	M	$> 10^{-4}$	In Remediation		10		√
24	SRL GROUNDWATER	Upper Three Runs	M	$> 10^{-4}$	In Remediation		10		√
387	SPILL ON 12/01/71 OF 1000 GAL OF RAD WATER FROM 773-A, NBN	Upper Three Runs	M	10^{-4} to 10^{-6}	In Remediation		9	√	
74	FIRE DEPARTMENT HOSE TRAINING FACILITY, 904-113G	Fourmile Branch	N	$< 10^{-6}$	Complete		9	A.1	
76	FORD BUILDING WASTE SITE, 643-11G	Fourmile Branch	N	$< 10^{-6}$	Complete		2	A.7//A.1	
228	SPILL ON 09/08/83 OF ~10 GAL OF FINE-ORGANIC #101 FROM	Fourmile Branch	N	$< 10^{-6}$	Complete		9	A.1	

Table 4.3a*
RBES Planned End State By Area

*Data Consistantw/2004 PMP

Unit Index #	Unit Name	Watershed	Facility Area	FY03 Estimated Risk	Status	Institutional Controls in Place	Waste Unit Group (Hazard Type)	Soil Remedial Action	Groundwater Remedial Action (NA)
SRS unique identification waste unit number	Unit Name with facility or building number (NBN = no building number).	One of six SRS Watersheds where the unit resides.	Specific SRS geographic area unit resides.	Relative level of risk to a receptor from the unit, with $<10^{-6}$ being the lowest level and $>>10^{-4}$ being the greatest.	Status of unit in the regulatory cleanup process.	Units checked have SRS controls in place to restrict inappropriate uses of land or facilities when contaminants remain at the unit.	One of 11 generic hazard types used to categorize all SRS waste units. (Definitions in Appendix K.)	Remedial action in place for soils media. (Alpha numeric corresponds to actions defined in Appendix K; check mark denotes remedial action as yet to be determined.)	Remedial action in place for groundwater media. (Alpha numeric corresponds to actions defined in Appendix D; check mark denotes remedial action as yet to be determined.)
	8307Z, NBN								
239	ARSENIC TREATED WOOD STORAGE AREA, NBN	Fourmile Branch	N	$< 10^{-6}$	Complete		5	A.1	
243	CENTRAL SHOPS AREA OF CONCERN, NBN	Fourmile Branch	N	$< 10^{-6}$	Complete		9	A.1	
355	SANDBLAST AREA CMN-002, NBN	Fourmile Branch	N	$< 10^{-6}$	Complete		9	A.1	
31	CENTRAL SHOPS BURNING/RUBBLE PIT, 631-6G	Pen Branch	N	10^{-4} to 10^{-6}	Complete	√	5	A.1	
60	CENTRAL SHOPS SLUDGE LAGOON, 080-24G	Pen Branch	N	$< 10^{-6}$	Complete		6	A.1	
75	FORD BUILDING SEEPAGE BASIN, 904-91G	Pen Branch	N	10^{-4} to 10^{-6}	Complete	√	2	A.2, A.3, A.7	
382	SPILL ON 10/09/85 OF 15 GAL OF AROPOL FROM 690-G, NBN	Pen Branch	N	$< 10^{-6}$	Complete		9	A.1	
499	CENTRAL SHOPS OPEN DISPOSAL TRENCH	Pen Branch	N	$< 10^{-6}$	Complete		5	A.1	

Table 4.3a*
RBES Planned End State By Area

*Data Consistantw/2004 PMP

Unit Index #	Unit Name	Watershed	Facility Area	FY03 Estimated Risk	Status	Institutional Controls in Place	Waste Unit Group (Hazard Type)	Soil Remedial Action	Groundwater Remedial Action (NA)
SRS unique identification waste unit number	Unit Name with facility or building number (NBN = no building number).	One of six SRS Watersheds where the unit resides.	Specific SRS geographic area unit resides.	Relative level of risk to a receptor from the unit, with $<10^{-6}$ being the lowest level and $>>10^{-4}$ being the greatest.	Status of unit in the regulatory cleanup process.	Units checked have SRS controls in place to restrict inappropriate uses of land or facilities when contaminants remain at the unit.	One of 11 generic hazard types used to categorize all SRS waste units. (Definitions in Appendix K.)	Remedial action in place for soils media. (Alpha numeric corresponds to actions defined in Appendix K; check mark denotes remedial action as yet to be determined.)	Remedial action in place for groundwater media. (Alpha numeric corresponds to actions defined in Appendix D; check mark denotes remedial action as yet to be determined.)
545	ECODS N-2 (ADJACENT TO MISCELLANEOUS RUBBLE PILE, 631-7G)	Pen Branch	N	$< 10^{-6}$	Complete		5	A.1	
132	SRL OIL TEST SITE, 080-16G	Pen Branch	N	10^{-4} to 10^{-6}	Complete		7	√	
57	CENTRAL SHOPS BURNING/RUBBLE PIT, 631-5G	Fourmile Branch	N	10^{-4} to 10^{-6}	In Assessment Phase		5	√	
244	CENTRAL SHOPS SCRAP LUMBER PILE, 631-2G	Fourmile Branch	N	10^{-4} to 10^{-6}	In Assessment Phase		5	√	
354	SANDBLAST AREA CMN-001, NBN	Fourmile Branch	N	10^{-4} to 10^{-6}	In Assessment Phase		9	√	
502	HEAVY EQUIPMENT WASH BASIN	Fourmile Branch	N	10^{-4} to 10^{-6}	In Assessment Phase		5	√	
77	G-AREA OIL SEEPAGE BASIN, 761-13G	Pen Branch	N	10^{-4} to 10^{-6}	In Assessment Phase		6	√	
82	HYDROFLUORIC ACID SPILL, 631-4G	Pen Branch	N	10^{-4} to 10^{-6}	In Assessment Phase		9	√	
309	MISCELLANEOUS RUBBLE PILE, 631-7G	Pen Branch	N	10^{-4} to 10^{-6}	In Assessment Phase		5	√	

Table 4.3a*
RBES Planned End State By Area

*Data Consistantw/2004 PMP

Unit Index #	Unit Name	Watershed	Facility Area	FY03 Estimated Risk	Status	Institutional Controls in Place	Waste Unit Group (Hazard Type)	Soil Remedial Action	Groundwater Remedial Action (NA)
SRS unique identification waste unit number	Unit Name with facility or building number (NBN = no building number).	One of six SRS Watersheds where the unit resides.	Specific SRS geographic area unit resides.	Relative level of risk to a receptor from the unit, with $<10^{-6}$ being the lowest level and $>>10^{-4}$ being the greatest.	Status of unit in the regulatory cleanup process.	Units checked have SRS controls in place to restrict inappropriate uses of land or facilities when contaminants remain at the unit.	One of 11 generic hazard types used to categorize all SRS waste units. (Definitions in Appendix K.)	Remedial action in place for soils media. (Alpha numeric corresponds to actions defined in Appendix K; check mark denotes remedial action as yet to be determined.)	Remedial action in place for groundwater media. (Alpha numeric corresponds to actions defined in Appendix D; check mark denotes remedial action as yet to be determined.)
311	NEW SALVAGE YARD, 741-G	Pen Branch	N	10-4 to 10-6	In Assessment Phase		5	√	
525	ECODS N-1 (SOUTH OF N AREA)	Pen Branch	N	10-4 to 10-6	In Assessment Phase		5	√	
58	CENTRAL SHOPS BURNING/RUBBLE PIT, 631-1G	Fourmile Branch	N	10-4 to 10-6	In Remediation		5	√	
59	CENTRAL SHOPS BURNING/RUBBLE PIT, 631-3G	Fourmile Branch	N	10-4 to 10-6	In Remediation		5	√	
17	P-AREA ACID/CAUSTIC BASIN, 904-78G	Lower Three Runs	P	$< 10^{-6}$	Complete		8	A.1, A.3	B.1
107	P-AREA BINGHAM PUMP OUTAGE PIT, 643-4G	Lower Three Runs	P	10-4 to 10-6	Complete	√	2	A.2	B.1
259	COMBINED SPILLS FROM 183-2P, NBN	Lower Three Runs	P	$< 10^{-6}$	Complete		9	A.1	
287	P-AREA ACID/CAUSTIC BASIN (GROUNDWATER)	Lower Three Runs	P	$< 10^{-6}$	Complete		10	A.1	B.1
428	SPILL ON 05/24/82 OF 10 GAL OF 31.5% ACID FROM 183-P, NBN	Lower Three Runs	P	$< 10^{-6}$	Complete		9	A.1	

Table 4.3a*
RBES Planned End State By Area

*Data Consistantw/2004 PMP

Unit Index #	Unit Name	Watershed	Facility Area	FY03 Estimated Risk	Status	Institutional Controls in Place	Waste Unit Group (Hazard Type)	Soil Remedial Action	Groundwater Remedial Action (NA)
SRS unique identification waste unit number	Unit Name with facility or building number (NBN = no building number).	One of six SRS Watersheds where the unit resides.	Specific SRS geographic area unit resides.	Relative level of risk to a receptor from the unit, with $<10^{-6}$ being the lowest level and $>>10^{-4}$ being the greatest.	Status of unit in the regulatory cleanup process.	Units checked have SRS controls in place to restrict inappropriate uses of land or facilities when contaminants remain at the unit.	One of 11 generic hazard types used to categorize all SRS waste units. (Definitions in Appendix K.)	Remedial action in place for soils media. (Alpha numeric corresponds to actions defined in Appendix K; check mark denotes remedial action as yet to be determined.)	Remedial action in place for groundwater media. (Alpha numeric corresponds to actions defined in Appendix D; check mark denotes remedial action as yet to be determined.)
109	P-AREA COAL PILE RUNOFF BASIN, 189-P	Steel Creek	P	$< 10^{-6}$	Complete		3	A.7//A.1	B.1
126	SPILL ON 03/15/79 OF 500 GALLONS OF CONTAMINATED WATER, NBN	Steel Creek	P	$< 10^{-6}$	Complete		9	A.1	
221	SANDBLAST AREA CMP-003, NBN	Steel Creek	P	$< 10^{-6}$	Complete		9	A.1	
315	P-AREA EROSION CONTROL SITE, 131-1P	Steel Creek	P	$< 10^{-6}$	Complete		9	A.1	
356	SANDBLAST AREA CMP-004, NBN	Steel Creek	P	$< 10^{-6}$	Complete		9	A.1	
358	SANDBLAST AREA CMP-001, NBN	Steel Creek	P	$< 10^{-6}$	Complete		9	A.1	
434	SPILL ON 05/09/85 OF 375 GAL OF PROCESS WATER FROM 106-P, NBN	Steel Creek	P	$< 10^{-6}$	Complete		9	A.1	
439	SPILL ON 06/26/86 OF 1 GAL OF TRITIATED WASTE OIL FROM 110-P, NBN	Steel Creek	P	$< 10^{-6}$	Complete		9	A.1	
453	SPILL ON 09/28/87 OF <30 GAL OF BROMOCIDE SOLN	Steel Creek	P	$< 10^{-6}$	Complete		9	A.1	

Table 4.3a*
RBES Planned End State By Area

*Data Consistantw/2004 PMP

Unit Index #	Unit Name	Watershed	Facility Area	FY03 Estimated Risk	Status	Institutional Controls in Place	Waste Unit Group (Hazard Type)	Soil Remedial Action	Groundwater Remedial Action (NA)
SRS unique identification waste unit number	Unit Name with facility or building number (NBN = no building number).	One of six SRS Watersheds where the unit resides.	Specific SRS geographic area unit resides.	Relative level of risk to a receptor from the unit, with $<10^{-6}$ being the lowest level and $>>10^{-4}$ being the greatest.	Status of unit in the regulatory cleanup process.	Units checked have SRS controls in place to restrict inappropriate uses of land or facilities when contaminants remain at the unit.	One of 11 generic hazard types used to categorize all SRS waste units. (Definitions in Appendix K.)	Remedial action in place for soils media. (Alpha numeric corresponds to actions defined in Appendix K; check mark denotes remedial action as yet to be determined.)	Remedial action in place for groundwater media. (Alpha numeric corresponds to actions defined in Appendix D; check mark denotes remedial action as yet to be determined.)
	FROM 607-22P, NBN								
498	SANDBLAST AREA CMP-002, NBN	Steel Creek	P	$< 10^{-6}$	Complete		9	A.1	
515	COMBINED SPILLS FROM 105-P, 106-P, AND 109-P, NBN	Steel Creek	P	$< 10^{-6}$	Complete		9	A.1	
538	ECODS P-1 (SOUTH OF P AREA)	Steel Creek	P	$< 10^{-6}$	Complete		5	A.1	
539	ECODS P-2 (SOUTH OF P AREA)	Steel Creek	P	$< 10^{-6}$	Complete		5	A.1	
547	P-AREA COAL PILE, NBN	Steel Creek	P	$< 10^{-6}$	In Assessment Phase		3	A.7//A.1	B.1
316	P-AREA REACTOR COOLING WATER SYSTEM, 186/190-P	Lower Three Runs	P	10-4 to 10-6	In Assessment Phase		2	√	
557	P-AREA PROCESS SEWER LINES AS ABANDONED, NBN	Lower Three Runs	P	$> 10^{-4}$	In Assessment Phase		4	√	
143	P-AREA REACTOR GROUNDWATER	Steel Creek	P	$> 10^{-4}$	In Assessment Phase		10		√

Table 4.3a*
RBES Planned End State By Area

*Data Consistantw/2004 PMP

Unit Index #	Unit Name	Watershed	Facility Area	FY03 Estimated Risk	Status	Institutional Controls in Place	Waste Unit Group (Hazard Type)	Soil Remedial Action	Groundwater Remedial Action (NA)
SRS unique identification waste unit number	Unit Name with facility or building number (NBN = no building number).	One of six SRS Watersheds where the unit resides.	Specific SRS geographic area unit resides.	Relative level of risk to a receptor from the unit, with $<10^{-6}$ being the lowest level and $>>10^{-4}$ being the greatest.	Status of unit in the regulatory cleanup process.	Units checked have SRS controls in place to restrict inappropriate uses of land or facilities when contaminants remain at the unit.	One of 11 generic hazard types used to categorize all SRS waste units. (Definitions in Appendix K.)	Remedial action in place for soils media. (Alpha numeric corresponds to actions defined in Appendix K; check mark denotes remedial action as yet to be determined.)	Remedial action in place for groundwater media. (Alpha numeric corresponds to actions defined in Appendix D; check mark denotes remedial action as yet to be determined.)
313	P-AREA ASH BASIN, 188-0P	Steel Creek	P	10-4 to 10-6	In Assessment Phase		3	√	
314	P-AREA DISASSEMBLY BASIN, 105-P	Steel Creek	P	> 10-4	In Assessment Phase		2	√	
317	P-AREA REACTOR SEEPAGE BASIN, 904-061G	Steel Creek	P	> 10-4	In Assessment Phase		2	√	
318	P-AREA REACTOR SEEPAGE BASIN, 904-062G	Steel Creek	P	> 10-4	In Assessment Phase		2	√	
319	P-AREA REACTOR SEEPAGE BASIN, 904-063G	Steel Creek	P	> 10-4	In Assessment Phase		2	√	
462	P-AREA REACTOR DISCHARGE CANAL, NBN	Steel Creek	P	> 10-4	In Assessment Phase		2	√	
477	P REACTOR AREA: P-AREA REACTOR AREA CASK CAR RAILROAD TRACKS AS ABANDONED, NBN	Steel Creek	P	> 10-4	In Assessment Phase		5	√	
108	P-AREA BURNING/RUBBLE PIT, 131-P	Steel Creek	P	10-4 to 10-6	In Remediation		5	√	√
112	R-AREA ACID/CAUSTIC BASIN, 904-77G	Lower Three Runs	R	< 10-6	Complete		8	A.1, A.3	B.1

Table 4.3a*
RBES Planned End State By Area

***Data Consistantw/2004 PMP**

Unit Index #	Unit Name	Watershed	Facility Area	FY03 Estimated Risk	Status	Institutional Controls in Place	Waste Unit Group (Hazard Type)	Soil Remedial Action	Groundwater Remedial Action (NA)
SRS unique identification waste unit number	Unit Name with facility or building number (NBN = no building number).	One of six SRS Watersheds where the unit resides.	Specific SRS geographic area unit resides.	Relative level of risk to a receptor from the unit, with $<10^{-6}$ being the lowest level and $>>10^{-4}$ being the greatest.	Status of unit in the regulatory cleanup process.	Units checked have SRS controls in place to restrict inappropriate uses of land or facilities when contaminants remain at the unit.	One of 11 generic hazard types used to categorize all SRS waste units. (Definitions in Appendix K.)	Remedial action in place for soils media. (Alpha numeric corresponds to actions defined in Appendix K; check mark denotes remedial action as yet to be determined.)	Remedial action in place for groundwater media. (Alpha numeric corresponds to actions defined in Appendix D; check mark denotes remedial action as yet to be determined.)
113	R-AREA BINGHAM PUMP OUTAGE PITS, 643-10G	Lower Three Runs	R	10-4 to 10-6	Complete	√	2	A.2	
114	R-AREA BINGHAM PUMP OUTAGE PITS, 643-8G	Lower Three Runs	R	10-4 to 10-6	Complete	√	2	A.2	
115	R-AREA BINGHAM PUMP OUTAGE PITS, 643-9G	Lower Three Runs	R	10-4 to 10-6	Complete	√	2	A.2	
178	R-AREA ASBESTOS PIT, 080-01R	Lower Three Runs	R	$< 10^{-6}$	Complete		5	A.1	
540	ECODS R-1A, -1B, -1C (EAST OF R REACTOR)	Lower Three Runs	R	$< 10^{-6}$	Complete		5	A.1	
550	R-AREA UNKNOWN PIT #1 (RUNK-1), NBN	Lower Three Runs	R	10-4 to 10-6	Complete	√	5	A.2	
551	R-AREA UNKNOWN PIT #2 (RUNK-2), NBN	Lower Three Runs	R	10-4 to 10-6	Complete	√	5	A.2	
552	R-AREA UNKNOWN PIT #3 (RUNK-3), NBN	Lower Three Runs	R	10-4 to 10-6	Complete	√	5	A.2	
179	R-AREA RUBBLE, PIT 131-2R	Upper Three Runs	R	$< 10^{-6}$	Complete		5	A.1	
42	108-4R OVERFLOW BASIN, 108-4R	Lower Three Runs	R	10-4 to 10-6	In Assessment Phase		2	√	

Table 4.3a*
RBES Planned End State By Area

***Data Consistantw/2004 PMP**

Unit Index #	Unit Name	Watershed	Facility Area	FY03 Estimated Risk	Status	Institutional Controls in Place	Waste Unit Group (Hazard Type)	Soil Remedial Action	Groundwater Remedial Action (NA)
SRS unique identification waste unit number	Unit Name with facility or building number (NBN = no building number).	One of six SRS Watersheds where the unit resides.	Specific SRS geographic area unit resides.	Relative level of risk to a receptor from the unit, with $<10^{-6}$ being the lowest level and $>>10^{-4}$ being the greatest.	Status of unit in the regulatory cleanup process.	Units checked have SRS controls in place to restrict inappropriate uses of land or facilities when contaminants remain at the unit.	One of 11 generic hazard types used to categorize all SRS waste units. (Definitions in Appendix K.)	Remedial action in place for soils media. (Alpha numeric corresponds to actions defined in Appendix K; check mark denotes remedial action as yet to be determined.)	Remedial action in place for groundwater media. (Alpha numeric corresponds to actions defined in Appendix D; check mark denotes remedial action as yet to be determined.)
116	R-AREA BURNING/RUBBLE PITS, 131-1R	Lower Three Runs	R	10-4 to 10-6	In Assessment Phase		5	√	
117	R-AREA BURNING/RUBBLE PITS, 131-R	Lower Three Runs	R	10-4 to 10-6	In Assessment Phase		5	√	
118	R-AREA RUBBLE PILE, 631-25G	Lower Three Runs	R	10-4 to 10-6	In Assessment Phase		5	√	
230	R-AREA CONCRETE LAKE, 183-1R/186R	Lower Three Runs	R	10-4 to 10-6	In Assessment Phase		9	√	
231	AREA ON THE NORTH SIDE OF BUILDING 105-R, NBN	Lower Three Runs	R	10-4 to 10-6	In Assessment Phase		9	√	
233	LAYDOWN AREA NORTH OF 105R, NBN	Lower Three Runs	R	10-4 to 10-6	In Assessment Phase		5	√	
271	COOLING WATER EFFLUENT SUMP, 107-R	Lower Three Runs	R	$> 10^{-4}$	In Assessment Phase		4	√	
288	R-AREA GROUNDWATER, NBN	Lower Three Runs	R	10-4 to 10-6	In Assessment Phase		10		√
312	OLD R-AREA DISCHARGE CANAL, NBN	Lower Three Runs	R	$> 10^{-4}$	In Assessment Phase		9	√	
324	POTENTIAL RELEASE OF NAOH/H2 SO4 FROM 183-2R, NBN	Lower Three Runs	R	10-4 to 10-6	In Assessment Phase		9	√	

Table 4.3a*
RBES Planned End State By Area

*Data Consistantw/2004 PMP

Unit Index #	Unit Name	Watershed	Facility Area	FY03 Estimated Risk	Status	Institutional Controls in Place	Waste Unit Group (Hazard Type)	Soil Remedial Action	Groundwater Remedial Action (NA)
SRS unique identification waste unit number	Unit Name with facility or building number (NBN = no building number).	One of six SRS Watersheds where the unit resides.	Specific SRS geographic area unit resides.	Relative level of risk to a receptor from the unit, with $<10^{-6}$ being the lowest level and $>>10^{-4}$ being the greatest.	Status of unit in the regulatory cleanup process.	Units checked have SRS controls in place to restrict inappropriate uses of land or facilities when contaminants remain at the unit.	One of 11 generic hazard types used to categorize all SRS waste units. (Definitions in Appendix K.)	Remedial action in place for soils media. (Alpha numeric corresponds to actions defined in Appendix K; check mark denotes remedial action as yet to be determined.)	Remedial action in place for groundwater media. (Alpha numeric corresponds to actions defined in Appendix D; check mark denotes remedial action as yet to be determined.)
329	R-AREA ASH BASIN, 188-0R	Lower Three Runs	R	10-4 to 10-6	In Assessment Phase		3	√	
330	R-AREA DISASSEMBLY BASIN, 105-R	Lower Three Runs	R	$> 10^{-4}$	In Assessment Phase		2	√	
478	R REACTOR AREA: R-AREA REACTOR AREA CASK CAR RAILROAD TRACKS AS ABANDONED, NBN	Lower Three Runs	R	$> 10^{-4}$	In Assessment Phase		5	√	
513	RELEASE FROM THE DECONTAMINATION OF R-AREA REACTOR DISASSEMBLY BASIN, NBN	Lower Three Runs	R	$> 10^{-4}$	In Assessment Phase		9	√	
517	COMBINED SPILLS NORTH OF BUILDING 105-R, NBN	Lower Three Runs	R	10-4 to 10-6	In Assessment Phase		9	√	
556	R-AREA PROCESS SEWER LINES AS ABANDONED, NBN	Lower Three Runs	R	$> 10^{-4}$	In Assessment Phase		4	√	
119	R-AREA REACTOR SEEPAGE BASINS, 904-103G	Upper Three Runs	R	$> 10^{-4}$	In Assessment Phase		2	√	√
120	R-AREA REACTOR SEEPAGE BASINS, 904-104G	Upper Three Runs	R	$> 10^{-4}$	In Assessment Phase		2	√	√

Table 4.3a*
RBES Planned End State By Area

***Data Consistantw/2004 PMP**

Unit Index #	Unit Name	Watershed	Facility Area	FY03 Estimated Risk	Status	Institutional Controls in Place	Waste Unit Group (Hazard Type)	Soil Remedial Action	Groundwater Remedial Action (NA)
SRS unique identification waste unit number	Unit Name with facility or building number (NBN = no building number).	One of six SRS Watersheds where the unit resides.	Specific SRS geographic area unit resides.	Relative level of risk to a receptor from the unit, with $<10^{-6}$ being the lowest level and $>>10^{-4}$ being the greatest.	Status of unit in the regulatory cleanup process.	Units checked have SRS controls in place to restrict inappropriate uses of land or facilities when contaminants remain at the unit.	One of 11 generic hazard types used to categorize all SRS waste units. (Definitions in Appendix K.)	Remedial action in place for soils media. (Alpha numeric corresponds to actions defined in Appendix K; check mark denotes remedial action as yet to be determined.)	Remedial action in place for groundwater media. (Alpha numeric corresponds to actions defined in Appendix D; check mark denotes remedial action as yet to be determined.)
121	R-AREA REACTOR SEEPAGE BASINS, 904-57G	Upper Three Runs	R	$> 10^{-4}$	In Assessment Phase		2	√	√
122	R-AREA REACTOR SEEPAGE BASINS, 904-58G	Upper Three Runs	R	$> 10^{-4}$	In Assessment Phase		2	√	√
123	R-AREA REACTOR SEEPAGE BASINS, 904-59G	Upper Three Runs	R	$> 10^{-4}$	In Assessment Phase		2	√	√
124	R-AREA REACTOR SEEPAGE BASINS, 904-60G	Upper Three Runs	R	$> 10^{-4}$	In Assessment Phase		2	√	√
161	DWPF CONCRETE BATCH PLANT, NBN	Upper Three Runs	S	$< 10^{-6}$	Complete		9	A.1	
339	S-AREA EROSION CONTROL SITE, NBN	Upper Three Runs	S	$< 10^{-6}$	Complete		9	A.1	
393	SPILL ON 02/20/85 OF 1 1/2 QT OF ACID MIXTURE FROM S-AREA TRAILER S-16, NBN	Upper Three Runs	S	$< 10^{-6}$	Complete		9	A.1	
425	SPILL ON 05/21/85 OF 20 GAL OF ACID FROM S-AREA, NBN	Upper Three Runs	S	$< 10^{-6}$	Complete		9	A.1	
206	TNX RUBBLE PILE, NBN	Savannah River / Floodplain / Swamp	T	$< 10^{-6}$	Complete		5	A.1	

Table 4.3a*
RBES Planned End State By Area

*Data Consistantw/2004 PMP

Unit Index #	Unit Name	Watershed	Facility Area	FY03 Estimated Risk	Status	Institutional Controls in Place	Waste Unit Group (Hazard Type)	Soil Remedial Action	Groundwater Remedial Action (NA)
SRS unique identification waste unit number	Unit Name with facility or building number (NBN = no building number).	One of six SRS Watersheds where the unit resides.	Specific SRS geographic area unit resides.	Relative level of risk to a receptor from the unit, with $<10^{-6}$ being the lowest level and $>>10^{-4}$ being the greatest.	Status of unit in the regulatory cleanup process.	Units checked have SRS controls in place to restrict inappropriate uses of land or facilities when contaminants remain at the unit.	One of 11 generic hazard types used to categorize all SRS waste units. (Definitions in Appendix K.)	Remedial action in place for soils media. (Alpha numeric corresponds to actions defined in Appendix K; check mark denotes remedial action as yet to be determined.)	Remedial action in place for groundwater media. (Alpha numeric corresponds to actions defined in Appendix D; check mark denotes remedial action as yet to be determined.)
267	COMBINED SPILLS FROM 672-T, NBN	Savannah River / Floodplain / Swamp	T	$< 10^{-6}$	Complete		9	A.1	
268	COMBINED SPILLS FROM 674-T (BONEYARD), NBN	Savannah River / Floodplain / Swamp	T	$< 10^{-6}$	Complete		9	A.1	
269	COMBINED SPILLS FROM 679-T, NBN	Savannah River / Floodplain / Swamp	T	$< 10^{-6}$	Complete		9	A.1	
350	SANDBLAST AREA CMT-001, NBN	Savannah River / Floodplain / Swamp	T	$< 10^{-6}$	Complete		9	A.1	
351	SANDBLAST AREA CMT-002, NBN	Savannah River / Floodplain / Swamp	T	$< 10^{-6}$	Complete		9	A.1	
401	SPILL ON 03/17/88 OF <1 GAL OF SULFURIC ACID, NBN	Savannah River / Floodplain / Swamp	T	$< 10^{-6}$	Complete		9	A.1	
443	SPILL ON 07/11/84 OF 4 GAL OF PROCESS SOLUTION, NBN	Savannah River / Floodplain / Swamp	T	$< 10^{-6}$	Complete		9	A.1	
104	NEW TNX SEEPAGE BASIN, 904-102G	Savannah River / Floodplain / Swamp	T	10-4 to 10-6	In Assessment Phase		2	√	
106	OLD TNX SEEPAGE BASIN, 904-076G	Savannah River / Floodplain / Swamp	T	$> 10^{-4}$	In Assessment Phase		2	√	
127	SPILL ON 01/12/53 OF 1/2 TON OF URANYL NITRATE, NBN	Savannah River / Floodplain / Swamp	T	10-4 to 10-6	In Assessment Phase		9	√	

Table 4.3a*
RBES Planned End State By Area

*Data Consistantw/2004 PMP

Unit Index #	Unit Name	Watershed	Facility Area	FY03 Estimated Risk	Status	Institutional Controls in Place	Waste Unit Group (Hazard Type)	Soil Remedial Action	Groundwater Remedial Action (NA)
SRS unique identification waste unit number	Unit Name with facility or building number (NBN = no building number).	One of six SRS Watersheds where the unit resides.	Specific SRS geographic area unit resides.	Relative level of risk to a receptor from the unit, with $<10^{-6}$ being the lowest level and $>>10^{-4}$ being the greatest.	Status of unit in the regulatory cleanup process.	Units checked have SRS controls in place to restrict inappropriate uses of land or facilities when contaminants remain at the unit.	One of 11 generic hazard types used to categorize all SRS waste units. (Definitions in Appendix K.)	Remedial action in place for soils media. (Alpha numeric corresponds to actions defined in Appendix K; check mark denotes remedial action as yet to be determined.)	Remedial action in place for groundwater media. (Alpha numeric corresponds to actions defined in Appendix D; check mark denotes remedial action as yet to be determined.)
139	TNX BURYING GROUND, 643-5G	Savannah River / Floodplain / Swamp	T	$> 10^{-4}$	In Assessment Phase		2	√	√
310	NEUTRALIZATION SUMP, 678-T	Savannah River / Floodplain / Swamp	T	10^{-4} to 10^{-6}	In Assessment Phase		4	√	
467	X-001 OUTFALL DRAINAGE DITCH, NBN	Savannah River / Floodplain / Swamp	T	10^{-4} to 10^{-6}	In Assessment Phase		9	√	
500	TNX OUTFALL DELTA, LOWER DISCHARGE GULLY, AND SWAMP, NBN	Savannah River / Floodplain / Swamp	T	10^{-4} to 10^{-6}	In Assessment Phase		9	√	
559	TNX Process Sewer Lines	Savannah River / Floodplain / Swamp	T	$> 10^{-4}$	In Assessment Phase		4	√	
25	TNX GROUNDWATER, 082-G	Savannah River / Floodplain / Swamp	T	$> 10^{-4}$	In Remediation		10		√

Table 4.3b
***EM Integrated Deactivation and Decommissioning Plan**
***Data consistent w/2004 PMP**

Name	Area	Risk/Hazard Type	Technology
		Conceptual Site Model Hazard / Current Risk	Decommissioning Alternative
TEST PILE	A	Other Industrial	Demolish
CHEMICAL FEED FACILITY	A	Other Industrial	Demolish
WASTE TREATMENT FACILITY	A	Other Industrial	Demolish
SEWAGE TREATMENT PLANT	A	Other Industrial	Demolish
SECURITY SOUTH ENTRY CONTROL	A	Never Contaminated	Demolish
GUARDHOUSE @ EMPLOYMENT ROAD	A	Never Contaminated	Demolish
GATEHOUSE, TECHNICAL AREA	A	Never Contaminated	Demolish
TELEPHONE EXCHANGE BUILDING	A	Other Industrial	Demolish
TELEPHONE BUILDING	A	Other Industrial	Demolish
COOLING WATER PUMP ENCLOSURE A/COMP RM	A	Other Industrial	Demolish
COOLING WATER PUMP ENCLOSURE B/COMP RM	A	Other Industrial	Demolish
DOE OFFICE BUILDING	A	Never Contaminated	Demolish
A&BA OFFICE BUILDING	A	Never Contaminated	Demolish
PUBLICATIONS BUILDING	A	Other Industrial	Demolish
COMPUTER BUILDING	A	Never Contaminated	Demolish
SUPPORT SERVICES BUILDING	A	Never Contaminated	Demolish
ADMINISTRATIVE CONTROL BUILDING	A	Never Contaminated	Demolish
ADMINISTRATION SUPPORT	A	Never Contaminated	Demolish
PUMP HOUSE	A	Never Contaminated	Demolish
ADMINISTRATION BUILDING	A	Other Industrial	Demolish
ENGINEERING OFFICE BUILDING	A	Never Contaminated	Demolish
FIELD OFFICE FOR DOE	A	Never Contaminated	Demolish

Table 4.3b			
*EM Integrated Deactivation and Decommissioning Plan			
*Data consistent w/2004 PMP			
		Risk/Hazard Type	Technology
Name	Area	Conceptual Site Model Hazard / Current Risk	Decommissioning Alternative
JANITORIAL SUBCONTRACT OFFICE	A	Never Contaminated	Demolish
CAFETERIA.	A	Never Contaminated	Demolish
FIRE STATION NO. 1	A	Never Contaminated	Demolish
WAREHOUSE BUILDING (EAST OF 714-A)	A	Never Contaminated	Demolish
STEEL AND PIPE STORAGE BUILDING	A	Never Contaminated	Demolish
LUMBER STORAGE	A	Never Contaminated	Demolish
CENTRAL STORES WAREHOUSE	A	Never Contaminated	Demolish
CENTRAL STORES STORAGE BUILDING	A	Never Contaminated	Demolish
CENTRAL STORES BUILDING	A	Never Contaminated	Demolish
SPARE MACHINERY STORAGE	A	Never Contaminated	Demolish
GASOLINE STATION	A	Other Industrial	Demolish
SUPPORT SERVICES LOWER 700-G	A	Never Contaminated	Demolish
REGULATED VEHICLE MAINTENANCE BUILDING	A	Other Industrial	Demolish
AUTOMOTIVE REPAIR SHOP	A	Other Industrial	Demolish
FPEG	A	Never Contaminated	Demolish
CSWE WORKS ENG FAC UPPER 700	A	Never Contaminated	Demolish
VARNISH DIP TANK FACILITY	A	Other Industrial	Demolish
MAINTENANCE WAREHOUSE	A	Never Contaminated	Demolish
STORAGE BUILDING LOWER 700-A	A	Never Contaminated	Demolish
STORAGE BUILDING MUM	A	Never Contaminated	Demolish
MAINTENANCE CENTRAL SHOP	A	Other Industrial	Demolish
CFOD & GENERAL COUNSEL BUILDING	A	Other Industrial	Demolish
MEDICAL AND EMPLOYMENT BUILDING	A	Never Contaminated	Demolish
CENTRAL ALARM STATION (CAS)	A	Never Contaminated	Demolish

Table 4.3b			
*EM Integrated Deactivation and Decommissioning Plan			
*Data consistent w/2004 PMP			
		Risk/Hazard Type	Technology
Name	Area	Conceptual Site Model Hazard / Current Risk	Decommissioning Alternative
PATROL HEADQUARTERS	A	Never Contaminated	Demolish
TRAINING SCHOOL AND LABORATORIES BLDG	A	Never Contaminated	Demolish
ELECTRICAL REPAIR SHOP	A	Never Contaminated	Demolish
MOTOR SHOP AND BALANCING FACILITY	A	Other Industrial	Demolish
COMPUTER & COMMUNICATIONS REPAIR BLDG	A	Never Contaminated	Demolish
STORAGE BUILDING	A	Never Contaminated	Demolish
STORAGE BUILDING	A	Never Contaminated	Demolish
ELECTRICAL REPAIR SHOP	A	Never Contaminated	Demolish
FIXTURE & EQUIPMENT STORAGE FACILITY	A	Never Contaminated	Demolish
ENGINEERING ASSISTANCE FACILITY	A	Never Contaminated	Demolish
STORAGE BUILDING	A	Never Contaminated	Demolish
T&T STORAGE SHED	A	Never Contaminated	Demolish
E&I VEHICLE STORAGE SHED	A	Never Contaminated	Demolish
E&I-CS- CENTRAL SHOP OFFICE COMPLEX	A	Never Contaminated	Demolish
PAINT SHOP	A	Other Industrial	Demolish
ENGINEERING AND TRAINING BUILDING	A	Never Contaminated	Demolish
OIL STORAGE BUILDING	A	Other Industrial	Demolish
FLAMMABLE STORAGE HOUSE	A	Other Industrial	Demolish
COMPRESSED GASES STORAGE	A	Never Contaminated	Demolish
RADIOLOGICAL & ENVIRONMENTAL SUP FAC	A	Other Industrial	Demolish
ETD EQUIPMENT STORAGE	A	Never Contaminated	Demolish
ENVIRONMENTAL STAGING BUILDING	A	Other Industrial	Demolish
HEALTH PROTECTION BOAT STORAGE BLDG	A	Never Contaminated	Demolish
METEOROLOGICAL SCIENCES LAB	A	Never Contaminated	Demolish

Table 4.3b			
*EM Integrated Deactivation and Decommissioning Plan			
*Data consistent w/2004 PMP			
		Risk/Hazard Type	Technology
Name	Area	Conceptual Site Model Hazard / Current Risk	Decommissioning Alternative
RADIOLOGICAL & ENVIRONMENTAL SCIENCE LAB	A	Other Industrial	Demolish
STANDARDS LABORATORY	A	Other Industrial	Demolish
NORMAL GREENHOUSE NO. 2	A	Never Contaminated	Demolish
NORMAL GREENHOUSE NO. 3	A	Never Contaminated	Demolish
RHIZOTRON FACILITY	A	Other Industrial	Demolish
WATERFOWL BREEDING PEN NO. 3	A	Never Contaminated	Demolish
WATERFOWL BREEDING PEN NO. 4	A	Never Contaminated	Demolish
COLD ROOM	A	Never Contaminated	Demolish
SREL STORAGE BUILDING	A	Never Contaminated	Demolish
BOAT STORAGE	A	Never Contaminated	Demolish
ANIMAL HOLDING FACILITY	A	Never Contaminated	Demolish
ANIMAL CARE FACILITY	A	Never Contaminated	Demolish
MODULAR OFFICE	A	Other Industrial	Demolish
SREL RECEIVING BUILDING	A	Never Contaminated	Demolish
HEAD HOUSE	A	Never Contaminated	Demolish
ISOTOPE GREENHOUSE-SREL COMPLEX	A	Never Contaminated	Demolish
GREENHOUSE-SREL COMPLEX	A	Never Contaminated	Demolish
SHOP	A	Other Industrial	Demolish
WATERFOWL BROODER HOUSE	A	Never Contaminated	Demolish
NORTH WATERFOWL BREEDING PEN NO. 1	A	Never Contaminated	Demolish
SOUTH WATERFOWL BREEDING PEN NO. 2	A	Never Contaminated	Demolish
ENVIRONMENTAL RESEARCH LAB	A	Never Contaminated	Demolish
ACID & SOLVENT STORAGE SHED	A	Chemical - Low Hazard	Demolish
STORAGE BUILDING	A	Never Contaminated	Demolish

Table 4.3b			
*EM Integrated Deactivation and Decommissioning Plan			
*Data consistent w/2004 PMP			
		Risk/Hazard Type	Technology
Name	Area	Conceptual Site Model Hazard / Current Risk	Decommissioning Alternative
SALVAGE AND RECLAMATION BUILDING	A	Other Industrial	Demolish
OFFICE BUILDING	A	Never Contaminated	Demolish
VEHICLE SHED	A	Never Contaminated	Demolish
RIGGING STORAGE	A	Never Contaminated	Demolish
EXCESS SALES BUILDING	A	Never Contaminated	Demolish
STORAGE FACILITY	A	Chemical - Low Hazard	Demolish
MAINTENANCE BUILDING	A	Other Industrial	Demolish
CONTROL HOUSE	A	Other Industrial	Demolish
PRIMARY SUBSTATION (HIGH VOLTAGE 115 KV)	A	Other Industrial	Demolish
DIESEL GENERATOR	A	Other Industrial	Demolish
PROPANE GENERATOR	A	Other Industrial	Demolish
UPS/GENERATOR ENCLOSURE	A	Other Industrial	Demolish
DIESEL GENERATOR FOR 703-44A	A	Other Industrial	Demolish
TIRE STORAGE BUILDING	A	Never Contaminated	Demolish
OFFICE OF COUNTERINTELLIGENCE	A	Never Contaminated	Demolish
CYLINDER STORAGE SHED	A	Never Contaminated	Demolish
SRL OFFICE BUILDING	A	Never Contaminated	Demolish
SRL OFFICE BUILDING	A	Never Contaminated	Demolish
ENGINEERING & PLANNING BUILDING	A	Never Contaminated	Demolish
PSP POWER SUPPLY BUILDING	A	Other Industrial	Demolish
ADMINISTRATIVE SERVICES	A	Never Contaminated	Demolish
CENTRAL RECORDS FACILITY	A	Never Contaminated	Demolish
MAIN TECHNICAL LABORATORY	A	Nuclear	Demolish
WASTE PROCESS AND FRACTURE TOUGHNESS FITNESS FAC	A	Nuclear	Demolish

Table 4.3b			
*EM Integrated Deactivation and Decommissioning Plan			
*Data consistent w/2004 PMP			
		Risk/Hazard Type	Technology
Name	Area	Conceptual Site Model Hazard / Current Risk	Decommissioning Alternative
MAINTENANCE WORK SHOP	A	Other Industrial	Demolish
CENTRAL COMPRESSOR BUILDING	A	Other Industrial	Demolish
HI LEVEL PIPE GALLERY ACCESS BUILDING	A	Other Industrial	Demolish
CONTROL HOUSE	A	Nuclear	Demolish
TANK BUILDING	A	Nuclear	Demolish
STRAINER CHANGE HOUSE	A	Nuclear	Demolish
HIGH LEVEL VENT FILTER HOUSE	A	Nuclear	Demolish
TANK BUILDING VENT AREA	A	Nuclear	Demolish
WASTE LOADING STATION	A	Nuclear	Demolish
STORAGE BUILDING	A	Other Industrial	Demolish
SITE UTILITIES OFFICE FACILITY	A	Other Industrial	Demolish
HEALTH PROTECTION STORAGE FACILITY	A	Other Industrial	Demolish
MANIPULATOR REPAIR SHOP	A	Other Industrial	Demolish
CHEMICAL FEED BUILDING-WEST OF 784-A	A	Chemical - Low Hazard	Demolish
CHLORINE FEED BUILDING FOR 785-A	A	Other Industrial	Demolish
3/700 TC FACILITY	A	Never Contaminated	Demolish
DOMESTIC WATER STORAGE TANK	A	Never Contaminated	Demolish
A-AREA DOMESTIC WATER CENTRAL TREATMENT PLANT	A	Chemical - Low Hazard	Demolish
MAINTENANCE SHOP BOILER HOUSE	A	Other Industrial	Demolish
E&I STORAGE BUILDING	A	Never Contaminated	Demolish
COAL HANDLER OBSERVATION BUILDING	A	Other Industrial	Demolish
BOILER HOUSE	A	Chemical - Low Hazard	Demolish
COOLING TOWER NO. 2	A	Never Contaminated	Demolish
CHILLER	A	Other Industrial	Demolish

Table 4.3b			
*EM Integrated Deactivation and Decommissioning Plan			
*Data consistent w/2004 PMP			
		Risk/Hazard Type	Technology
Name	Area	Conceptual Site Model Hazard / Current Risk	Decommissioning Alternative
COOLING TOWER	A	Never Contaminated	Demolish
HEAT TRANSFER LABORATORY	A	Other Industrial	Demolish
POLLUTION CONTROL STACK, 773-A	A	Other Industrial	Demolish
EXHAUST FAN HOUSE	A	Other Industrial	Demolish
SAND FILTER AND SUPPLY TUNNEL	A	Other Industrial	Demolish
CHEMICAL FEED FAC	B	Other Industrial	Demolish
SANITARY WASTE WATER FACILITY	B	Other Industrial	ISD
KENNEL FACILITIES	B	Never Contaminated	Demolish
WSI TRAINING BLDG	B	Never Contaminated	Demolish
HELICOPTER SUPP FAC, HANGER	B	Other Industrial	Demolish
HELICOPTER SUPP FAC OPR ANN	B	Other Industrial	Demolish
WSI ADMINISTRATION BLDG	B	Never Contaminated	Demolish
WSI TRAINING BUILDING	B	Never Contaminated	Demolish
B-AREA ENGINEER SUPPORT BLDG	B	Never Contaminated	Demolish
HAZARDOUS CHEMICAL STORAGE	B	Other Industrial	Demolish
HAZARDOUS CHEMICAL STORAGE	B	Other Industrial	Demolish
STORAGE	B	Other Industrial	Demolish
WSI AUTOMOTIVE SHOP	B	Chemical - Low Hazard	Demolish
RECORDS STORAGE BLDG NO.2	B	Other Industrial	Demolish
ENGINEERING SUPPORT FACILITY	B	Never Contaminated	Demolish
ADMINISTRATION BUILDING NO. 2	B	Never Contaminated	Demolish
ADMINISTRATION BUILDING NO. 3	B	Never Contaminated	Demolish
ENGINEERING CENTER	B	Never Contaminated	Demolish
REGULATORY MONITORING & BIOASSAY LAB AUXILIARY	B	Chemical - Low Hazard	Demolish

Table 4.3b			
*EM Integrated Deactivation and Decommissioning Plan			
*Data consistent w/2004 PMP			
		Risk/Hazard Type	Technology
Name	Area	Conceptual Site Model Hazard / Current Risk	Decommissioning Alternative
HEALTH PROTECTION CALIBRATION FACILITY	B	Other Industrial	Demolish
WHOLE BODY COUNT FACILITY	B	Never Contaminated	Demolish
HEALTH PROTECTION RADIOLOGICAL	B	Chemical - Low Hazard	Demolish
5000 KVA SUBSTATION	B	Other Industrial	Demolish
RESEARCH LABORATORY (EPA STREAMS)	B	Other Industrial	Demolish
STORAGE & LAB FAC	B	Other Industrial	Demolish
CHILLER BUILDING COOLING TOWER	B	Other Industrial	Demolish
CHILLER BUILDING	B	Other Industrial	Demolish
REFRIGERATION BUILDING	B	Chemical - Low Hazard	Demolish
AMMUNITION BUNKER	B	Never Contaminated	Demolish
FIRE WATER PUMP HOUSE	B	Other Industrial	Demolish
REACTOR BUILDING	C	Nuclear	ISD
COOLING WATER EFFLUENT SUMP	C	Other Industrial	ISD
ENGINE HOUSE	C	Other Industrial	ISD
ENGINE HOUSE	C	Other Industrial	ISD
PRIMARY SUBSTATION (HIGH VOLT 115/13.8)	C	Other Industrial	ISD
PRIMARY SUBSTATION (HIGH VOLT 115/13.8)	C	Other Industrial	ISD
GENERATOR ROOM	C	Other Industrial	Demolish
STORAGE BUILDING	C	Never Contaminated	Demolish
COOLING WATER RESERVOIR	C	Other Industrial	ISD
COOLING WATER PUMP HOUSE	C	Other Industrial	ISD
FENCE & RD LIGHTING (INC REGU & TRANS)	C	Other Industrial	Demolish
AIR COMPRESSOR BUILDING	C	Never Contaminated	Demolish
EFFLUENT MONITORING BUILDING	C	Other Industrial	Demolish

Table 4.3b			
*EM Integrated Deactivation and Decommissioning Plan			
*Data consistent w/2004 PMP			
		Risk/Hazard Type	Technology
Name	Area	Conceptual Site Model Hazard / Current Risk	Decommissioning Alternative
AREA GATEHOUSE & PATROL HQ	C	Other Industrial	Demolish
GATEHOUSE ENTRANCE AT BLDG 105	C	Other Industrial	Demolish
TELEPHONE EXCHANGE BUILDING	C	Other Industrial	Demolish
TELEPHONE EXCHANGE BUILDING	C	Other Industrial	Demolish
AREA ADM & SERVICES BUILDING	C	Never Contaminated	Demolish
REACTOR ENGINEERING OFFICE BUILDING	C	Never Contaminated	Demolish
REACTOR SUPPORT SERVICES BUILDING	C	Never Contaminated	Demolish
REACTOR TRAINING FACILITY	C	Never Contaminated	Demolish
OFFICE BUILDING	C	Never Contaminated	Demolish
REACTOR SIMULATOR TRAINING FACILITY	C	Never Contaminated	Demolish
MAINTENANCE MATERIAL STORAGE BUILDING	C	Other Industrial	Demolish
CONTAMINATED MAINTENANCE FACILITY	C	Other Industrial	Demolish
FIRE FIGHTING SIMULATOR BLDG (FOREST OFFICE	D	Other Industrial	Demolish
TUBE BUNDLE CLEANING SHELTER	D	Other Industrial	Demolish
WEST SUBSTATION B	D	Other Industrial	Demolish
EAST SUBSTATION A	D	Other Industrial	Demolish
STORAGE BUILDING	D	Other Industrial	Demolish
MASK MAINTENANCE BUILDING	D	Other Industrial	Demolish
STORAGE BUILDING EAST	D	Other Industrial	Demolish
STORAGE BUILDING WEST	D	Other Industrial	Demolish
REWORK HANDLING FACILITY	D	Radiological	Demolish
CONCENTRATOR BUILDING	D	Radiological	Demolish
MODERATOR HANDLING AND STORAGE	D	Other Industrial	Demolish
DRUM STORAGE	D	Other Industrial	Demolish

Table 4.3b			
*EM Integrated Deactivation and Decommissioning Plan			
*Data consistent w/2004 PMP			
		Risk/Hazard Type	Technology
Name	Area	Conceptual Site Model Hazard / Current Risk	Decommissioning Alternative
HEAVY WATER EQUIPMENT STORAGE	D	Other Industrial	Demolish
FINISHING BUILDING	D	Other Industrial	Demolish
PRIMARY SUBSTATION (HIGH VOLTAGE 115 KV)	D	Other Industrial	Demolish
DIESEL FUEL UNDERGROUND STORAGE TANK	D	Other Industrial	Demolish
MAINTENANCE MATL. STORAGE	D	Other Industrial	Demolish
MAINTENANCE FIELD OFFICE AND SHOP	D	Other Industrial	Demolish
MOTOR CONTROL CENTER	D	Other Industrial	Demolish
WATER FILTRATION AND TREATMENT PLANT	D	Other Industrial	Demolish
SOFTENER AND SILICA ABSORBER BLDG.	D	Other Industrial	Demolish
ELECTRICAL CONTROL BUILDING	D	Other Industrial	Demolish
CHEMICAL FEED SYSTEMS FOR DOMESTIC WATER	D	Chemical - Low Hazard	Demolish
SOFTENER BUILDING	D	Other Industrial	ISD
OIL SHED BUILDING	D	Other Industrial	Demolish
STORAGE BUILDING	D	Other Industrial	Demolish
STORAGE BUILDING	D	Other Industrial	Demolish
STORAGE SHED	D	Other Industrial	Demolish
POWER MAINTENANCE FACILITY BUILDING	D	Other Industrial	Demolish
VALVE HOUSE	D	Other Industrial	Demolish
POWERHOUSE	D	Other Industrial	Demolish
COOLING TOWER	D	Other Industrial	Demolish
CHEMICAL FEED FACILITY	D	Other Industrial	Demolish
MAINTENANCE SUPPORT ADMINISTRATION BUILDING	D	Other Industrial	Demolish
TELEPHONE EXCHANGE BUILDING	D	Other Industrial	Demolish
AREA ADM. BLDG. & FIRST AID	D	Other Industrial	Demolish

Table 4.3b			
*EM Integrated Deactivation and Decommissioning Plan			
*Data consistent w/2004 PMP			
		Risk/Hazard Type	Technology
Name	Area	Conceptual Site Model Hazard / Current Risk	Decommissioning Alternative
JANITORIAL SUBCONTRACT OFFICE	D	Other Industrial	Demolish
STORAGE BUILDING	D	Other Industrial	Demolish
STORAGE BUILDING	D	Other Industrial	Demolish
T&T OFFICE AND STORAGE BUILDING	D	Other Industrial	Demolish
STORAGE AREA	D	Other Industrial	Demolish
WELDING SHOP	D	Other Industrial	Demolish
SHOPS, STORES AND CHANGE HOUSE	D	Other Industrial	Demolish
CONTROL LABORATORY AND SUPERVISOR'S OFFICE	D	Other Industrial	Demolish
HIGH POINT VALVE BOX	E	Other Industrial	ISD
ADMINISTRATIVE BUILDING	E	Never Contaminated	Demolish
Mixed Waste Storage	E	Nuclear	Demolish
MIXED WASTE STORAGE EXPANSION	E	Nuclear	Demolish
STORAGE/WORK SPACE, MAINT, RIGGING, HEAVY EQUIP	E	Other Industrial	Demolish
STORAGE/WORK SPACE, MAINT, RIGGING, HEAVY EQUIP	E	Other Industrial	Demolish
TRU WASTE STORAGE PAD NO. 14	E	Nuclear	Demolish
TRU WASTE STORAGE PAD NO. 15	E	Nuclear	Demolish
TRU WASTE STORAGE PAD NO. 16	E	Nuclear	Demolish
TRU WASTE STORAGE PAD NO. 17	E	Nuclear	Demolish
TRU WASTE STORAGE PAD NO. 18	E	Nuclear	Demolish
TRU WASTE STORAGE PAD NO. 19	E	Nuclear	Demolish
TRU WASTE STORAGE PAD NO. 3	E	Nuclear	Demolish
TRU WASTE STORAGE PAD NO. 4	E	Nuclear	Demolish
TRU WASTE STORAGE PAD NO. 5	E	Nuclear	Demolish
TRU WASTE STORAGE PAD NO. 6	E	Nuclear	Demolish

Table 4.3b			
*EM Integrated Deactivation and Decommissioning Plan			
*Data consistent w/2004 PMP			
		Risk/Hazard Type	Technology
Name	Area	Conceptual Site Model Hazard / Current Risk	Decommissioning Alternative
LOW ACTIVITY WASTE VAULT	E	Nuclear	ISD
ILT VAULT	E	Nuclear	ISD
ILNT VAULT	E	Nuclear	ISD
ASSOCIATED WASTE SHREDDER BUILDING	E	Other Industrial	Demolish
OFFICE/STORAGE BUILDING	E	Never Contaminated	Demolish
BURYING GROUND ADMINISTRATION BUILDING	E	Other Industrial	Demolish
EXPERIMENTAL TRU WASTE ASSAY BUILDING	E	Nuclear	Demolish
CONTROL HOUSE	F	Other Industrial	Demolish
CONTROL AND CHECK HOUSE	F	Other Industrial	Demolish
WASTE TRUCK UNLOADING HOUSE	F	Nuclear	Demolish
CHEMICAL HANDLING FACILITY	F	Other Industrial	Demolish
STORES DROP POINT	F	Never Contaminated	Demolish
CANYON AUXILIARIES	F	Nuclear	Demolish
URANIUM OXIDE STORAGE	F	Nuclear	Demolish
CONTROL AND ALARM CENTER	F	Never Contaminated	ISD
CONSTRUCTION LAYDOWN & B25 STORAGE BLDG	F	Never Contaminated	Demolish
A - LINE	F	Nuclear	Demolish
COMPRESSOR BUILDING	F	Other Industrial	Demolish
URANIUM OXIDE STORAGE BUILDING	F	Nuclear	Demolish
STORAGE BUILDING	F	Nuclear	Demolish
EQUIPMENT STORAGE FACILITY	F	Other Industrial	Demolish
STORAGE BUILDING	F	Never Contaminated	Demolish
SEPARATIONS PLANNING & SCHEDULING BLDG.	F	Never Contaminated	Demolish
MATERIAL ACCESS CENTER WAREHOUSE	F	Chemical - Low Hazard	Demolish

Table 4.3b			
*EM Integrated Deactivation and Decommissioning Plan			
*Data consistent w/2004 PMP			
		Risk/Hazard Type	Technology
Name	Area	Conceptual Site Model Hazard / Current Risk	Decommissioning Alternative
CONSTRUCTION CHANGE FACILITY	F	Other Industrial	Demolish
CANYON BUILDING	F	Nuclear	ISD
COLD FEED PREP. AREA	F	Chemical - Low Hazard	Demolish
REFRIGERATION BLDG. NO. 1	F	Other Industrial	Demolish
REFRIGERATION BLDG. NO. 2	F	Other Industrial	Demolish
METALLURGICAL BUILDING	F	Nuclear	ISD
STORAGE/SUPPLY BUILDING	F	Never Contaminated	Demolish
GANG VALVE HOUSE	F	Nuclear	Demolish
WEST PUMP HOUSE	F	Other Industrial	Demolish
EAST PUMP HOUSE	F	Other Industrial	ISD
CONTROL ROOM/MCC	F	Nuclear	Demolish
CONTROL ROOM	F	Nuclear	Demolish
COOLING TOWERS/PUMP HOUSE SER. 25-28,44-47	F	Other Industrial	Demolish
FDB-4 AND FPPs 2 AND 3	F	Nuclear	Demolish
OFFICE/CHANGE ROOMS	F	Other Industrial	Demolish
FDB-1	F	Nuclear	ISD
FDB-6 DIVERSION BOX	F	Nuclear	Demolish
FDB-5 DIVERSION BOX	F	Nuclear	Demolish
AIR COMPRESSOR BUILDING	F	Other Industrial	Demolish
MAINTENANCE SHOP BUILDING	F	Never Contaminated	Demolish
MCC BUILDING	F	Other Industrial	Demolish
AIR COMPRESSOR BLDG.	F	Other Industrial	Demolish
BREATHING AIR COMPRESSOR BLDG.	F	Other Industrial	Demolish
CONTROL ROOM/MCC	F	Nuclear	Demolish

Table 4.3b			
*EM Integrated Deactivation and Decommissioning Plan			
*Data consistent w/2004 PMP			
		Risk/Hazard Type	Technology
Name	Area	Conceptual Site Model Hazard / Current Risk	Decommissioning Alternative
WASTE STORAGE TANK	F	Nuclear	ISD
WASTE STORAGE TANK	F	Nuclear	ISD
RADCON TRAILER NEAR TANK 4	F	Other Industrial	Demolish
RADCON TRAILER NEAR 1F EVAPORATOR	F	Other Industrial	Demolish
RADCON TRAILER AND 2F EVAPORATOR	F	Other Industrial	Demolish
2F EVAPORATOR	F	Nuclear	Demolish
CTS PIT	F	Other Industrial	ISD
RADCON TRAILER NEAR FDB-2	F	Other Industrial	Demolish
RADCON TRAILER NEAR TANKS 33/34	F	Other Industrial	Demolish
1F EVAPORATOR	F	Nuclear	Demolish
BLEND CABINET STORAGE BLDG	F	Other Industrial	Demolish
EQUIPMENT TEST FACILITY	F	Other Industrial	Demolish
WAREHOUSE	F	Never Contaminated	Demolish
WAREHOUSE	F	Never Contaminated	Demolish
EC PROCESS BUILDING	F	Other Industrial	Demolish
COMPRESSED GAS STORAGE BUILDING	F	Other Industrial	Demolish
MANUFACTURING BUILDING	F	Radiological	Demolish
FAB SHOP	F	Other Industrial	Demolish
PRIMARY SUBSTATION (HIGH VOLTAGE 115KV)	F	Other Industrial	Demolish
SECONDARY TRANSFORMER STATION FOR 241F	F	Other Industrial	Demolish
SUBSTATION NEXT TO 772-F	F	Other Industrial	Demolish
TRANSFORMER-1	F	Other Industrial	Demolish
TRANSFORMER - 2	F	Other Industrial	Demolish
DIESEL GENERATOR BUILDING	F	Other Industrial	Demolish

Table 4.3b			
*EM Integrated Deactivation and Decommissioning Plan			
*Data consistent w/2004 PMP			
		Risk/Hazard Type	Technology
Name	Area	Conceptual Site Model Hazard / Current Risk	Decommissioning Alternative
DIESEL GENERATOR FACILITY, 246-F	F	Other Industrial	Demolish
DIESEL HOUSE	F	Nuclear	Demolish
DIESEL GENERATOR	F	Other Industrial	Demolish
DIESEL GENERATOR	F	Other Industrial	Demolish
STORAGE SHED	F	Never Contaminated	Demolish
CHEMICAL FEED BUILDING	F	Nuclear	Demolish
CHEMICAL FEED BUILDING	F	Other Industrial	Demolish
FILTER AND DEIONIZER FACILITY	F	Other Industrial	Demolish
RETURN WATER DELAYING BASIN	F	Nuclear	ISD
COOLING WATER ACTIVITIES MONITORING BLDG	F	Nuclear	Demolish
RETURN WATER PUMPING BASIN	F	Nuclear	Demolish
MONITORING HOUSE	F	Nuclear	Demolish
SEGREGATED WATER DELAYING BASIN	F	Nuclear	ISD
MONITORING HOUSE	F	Nuclear	Demolish
STORAGE BASIN, 4 MILLION GALLON, LINED	F	Radiological	Demolish
RESERVOIR AND PUMP HOUSE	F	Other Industrial	Demolish
E&I SAFEGUARDS & SECURITY SHOP	F	Nuclear	Demolish
POWER SERVICE BUILDING	F	Other Industrial	Demolish
STORAGE BUILDING	F	Never Contaminated	Demolish
CHILLER BUILDING	F	Other Industrial	Demolish
COOLING TOWER NO. 1	F	Other Industrial	Demolish
COOLING TOWER	F	Other Industrial	Demolish
COOLING TOWER	F	Other Industrial	Demolish
CANYON STACK	F	Radiological	Demolish

Table 4.3b *EM Integrated Deactivation and Decommissioning Plan *Data consistent w/2004 PMP			
		Risk/Hazard Type	Technology
Name	Area	Conceptual Site Model Hazard / Current Risk	Decommissioning Alternative
VESSEL VENT FAN HOUSE	F	Radiological	Demolish
SAND FILTER FAN HOUSE	F	Radiological	Demolish
CANYON EXHAUST FAN HOUSE	F	Radiological	Demolish
METALLURGICAL BUILDING STACK	F	Radiological	Demolish
ADDITIONAL CANYON SAND FILTER	F	Nuclear	Demolish
SAND FILTER FOR 235-F	F	Nuclear	Demolish
CANYON EXHAUST FILTERS	F	Nuclear	Demolish
CHEMICAL FEED FACILITY	F	Other Industrial	Demolish
LIFT STATION	F	Radiological	ISD
NAVAL FUEL PUMP STA FOR WASTEWATER TREATMENT FAC	F	Other Industrial	Demolish
F-AREA PUMP STA WSTWTR TRTMNT FAC	F	Other Industrial	Demolish
INTER TRANS LINES DVRBOX/PUMP PIT (FDB-2)	F	Nuclear	ISD
PATROL HEADQUARTERS	F	Other Industrial	Demolish
GUARDHOUSE	F	Never Contaminated	Demolish
GUARDHOUSE	F	Never Contaminated	Demolish
GATEHOUSE ENTRANCE TO 235-F	F	Never Contaminated	Demolish
GATEHOUSE	F	Never Contaminated	Demolish
TELEPHONE EXCHANGE BUILDING	F	Other Industrial	Demolish
SEPARATIONS SUPPORT BUILDING	F	Never Contaminated	Demolish
TEMP ADMINISTRATION BLDG	F	Never Contaminated	Demolish
AREA ADMIN AND SER. BLDG.	F	Other Industrial	Demolish
PROJECT OFFICE BUILDING	F	Never Contaminated	Demolish
A-LINE CHANGE HOUSE	F	Other Industrial	Demolish

Table 4.3b			
*EM Integrated Deactivation and Decommissioning Plan			
*Data consistent w/2004 PMP			
		Risk/Hazard Type	Technology
Name	Area	Conceptual Site Model Hazard / Current Risk	Decommissioning Alternative
REGULATED SHOPS	F	Other Industrial	Demolish
GENERAL ADMINISTRATIVE FACILITY	F	Never Contaminated	Demolish
SEPARATIONS SUPPORT SERVICES	F	Never Contaminated	Demolish
FIRE PROTECTION EQUIPMENT BUILDING	F	Other Industrial	Demolish
FIRE STATION #2	F	Never Contaminated	Demolish
PIPE SHOP	F	Never Contaminated	Demolish
STEEL & PIPE STORAGE BUILDING	F	Never Contaminated	Demolish
OFFICE BUILDING	F	Never Contaminated	Demolish
CRAFT BLDG/STORAGE 235-F	F	Never Contaminated	Demolish
CONST CRAFT MATERIAL STORAGE BLDG	F	Other Industrial	Demolish
AREA SHOPS	F	Other Industrial	Demolish
CENTRAL ALARM STATION (CAS)	F	Never Contaminated	Demolish
CONSTRUCTION LAUNDRY ROOM	F	Other Industrial	Demolish
LAUNDRY	F	Other Industrial	Demolish
URANIUM OXIDE STORAGE	F	Nuclear	Demolish
RESPIRATOR FIT TEST TRAILER	F	Other Industrial	Demolish
STORAGE BUILDING	F	Nuclear	Demolish
PRODUCTION CONTROL FACILITY	F	Nuclear	Demolish
LAB HEPA FILTRATION BLDG	F	Radiological	Demolish
CONTROL LABORATORY	F	Nuclear	ISD
FIRE WATER PUMP HOUSE	F	Never Contaminated	Demolish
WASTE TANK PROCESS WATER WELL SW 284-F	F	Other Industrial	Demolish
WELL, NORTH OF 252-7F (ABANDONED)	F	Other Industrial	Demolish
SWITCHING STATION	G	Other Industrial	Demolish

Table 4.3b			
*EM Integrated Deactivation and Decommissioning Plan			
*Data consistent w/2004 PMP			
		Risk/Hazard Type	Technology
Name	Area	Conceptual Site Model Hazard / Current Risk	Decommissioning Alternative
SWITCHING STATION	G	Other Industrial	Demolish
SWITCHING STATION	G	Other Industrial	Demolish
CHEM FEED BLDG WSTWTR TRTMNT EQPM	G	Other Industrial	Demolish
INFLUENT HEADWRKS FOR WASTEWATER TREATMENT EQPMN	G	Other Industrial	Demolish
EQUALIZATION BASIN WSTWTR TRTMNT EQPM	G	Other Industrial	ISD
EQUALIZATION BASIN WSTWTR TRTMNT EQPM	G	Other Industrial	ISD
PUMP STA 4000B WSTWTR TRTMNT FAC	G	Other Industrial	ISD
PUMP STA 4000C WSTWTR TRTMNT FAC	G	Other Industrial	ISD
PUMP STA5000A WSTWTR TRTMNT FAC	G	Other Industrial	ISD
PUMP STA 6000A WSTWTR TRTMNT FAC	G	Other Industrial	ISD
OXIDATN DITCH & CLAR #1 WSTWTR TRTMNT EQPM	G	Other Industrial	ISD
OXIDATN DITCH CLAR#2 WSTWTR TREATMENT EQPM	G	Other Industrial	ISD
OXIDATN DITCH & CLAR #3 WASTWTR TRTMNT EQP	G	Other Industrial	ISD
UV DISINFCTN BSN CASCADE UNIT WSTWTR TRTMNT	G	Other Industrial	ISD
SLUDGE THICKENER WSTWTR TRTMNT EQP	G	Other Industrial	Demolish
PUMP STATION 2000B WSTWTR TRTMNT FAC	G	Other Industrial	ISD
PUMP STN 3000A WASTEWATER TREATMENT FACL	G	Other Industrial	ISD
PUMP STN 4000A WASTEWATER TREATMENT FACL	G	Other Industrial	ISD
CSWTF MAINTENANCE BUILDING	G	Chemical - Low Hazard	Demolish
SANITARY SEWAGE PUMP STATION	G	Other Industrial	ISD
TRACK SCALE HOUSE	G	Never Contaminated	Demolish
TRACK MAINTENANCE BUILDING	G	Never Contaminated	Demolish
WIND DATA BUILDING-N OF A-AREA	G	Never Contaminated	Demolish

Table 4.3b			
*EM Integrated Deactivation and Decommissioning Plan			
*Data consistent w/2004 PMP			
		Risk/Hazard Type	Technology
Name	Area	Conceptual Site Model Hazard / Current Risk	Decommissioning Alternative
WIND DATA BUILDING-N-NW OF H-AREA	G	Never Contaminated	Demolish
WIND DATA BUILDING-E-SE OF F-AREA	G	Never Contaminated	Demolish
WIND DATA BUILDING-S-SE OF C-AREA	G	Never Contaminated	Demolish
WIND DATA BUILDING-E-SE OF K-AREA	G	Never Contaminated	Demolish
WIND DATA BUILDING-SE OF P-AREA	G	Never Contaminated	Demolish
WIND DATA BUILDING-E OF L-AREA	G	Never Contaminated	Demolish
EQUIPMENT SHED	G	Never Contaminated	Demolish
EQUIPMENT SHED	G	Never Contaminated	Demolish
EQUIPMENT SHED	G	Never Contaminated	Demolish
EQUIPMENT SHED	G	Never Contaminated	Demolish
EQUIPMENT SHED	G	Never Contaminated	Demolish
EQUIPMENT SHED	G	Never Contaminated	Demolish
EQUIPMENT SHED	G	Never Contaminated	Demolish
EQUIPMENT SHED	G	Never Contaminated	Demolish
EQUIPMENT SHED	G	Never Contaminated	Demolish
EQUIPMENT SHED	G	Never Contaminated	Demolish
EQUIPMENT SHED	G	Never Contaminated	Demolish
SECURITY CLASS ROOM	G	Never Contaminated	Demolish
LOCOMOTIVE SHOP	G	Other Industrial	Demolish
COMMUNICATIONS FACILITY	G	Other Industrial	Demolish
RADIO TRUNKING TOWER	G	Never Contaminated	Demolish
WAREHOUSE	G	Never Contaminated	Demolish
PRIMARY TRANSFORMER SUBSTATION/681-1G	G	Other Industrial	Demolish
PRIMARY TRANSFORMER SUBSTATION/681-3G	G	Other Industrial	Demolish

Table 4.3b			
*EM Integrated Deactivation and Decommissioning Plan			
*Data consistent w/2004 PMP			
		Risk/Hazard Type	Technology
Name	Area	Conceptual Site Model Hazard / Current Risk	Decommissioning Alternative
PRIMARY TRANSFORMER SUBSTATION/681-6G	G	Other Industrial	Demolish
EMERG TRNS WSTEWTR TRTMT EQUIP (WAS 654001G	G	Other Industrial	Demolish
FIRING SHED	G	Never Contaminated	Demolish
PATROL TRAINING BLDG-RIFLE & PISTOL RANGE	G	Never Contaminated	Demolish
UP-STREAM WATER PUMP HOUSE FOR 100 AREAS	G	Other Industrial	Demolish
CHLORINE BUILDING	G	Other Industrial	Demolish
DOWN-STREAM WATER PUMP HOUSE FOR 100AREA	G	Other Industrial	Demolish
WATER PUMP HOUSE FOR 400 AREA	G	Other Industrial	Demolish
PAR POND PUMP HOUSE	G	Other Industrial	Demolish
PUMP HOUSE EQUIP BLDG-ADJACENT TO 681-6G	G	Other Industrial	Demolish
WELLHSE & HYDROPNEUMATIC TANK WASTWTR TREATMNT E	G	Other Industrial	Demolish
ELEVATED WATER STORAGE TANK	G	Never Contaminated	Demolish
ELEVATED WATER STORAGE TANK	G	Never Contaminated	Demolish
DAM SERVICE BUILDING	G	Other Industrial	Demolish
GUARDHOUSE HW 125 - RD. 3	G	Never Contaminated	Demolish
GUARDHOUSE HW 125 - RD. 6	G	Never Contaminated	Demolish
GUARDHOUSE AT RD 1 AND D-1 (PECAN GATE)	G	Never Contaminated	Demolish
GATEHOUSE, ALLENDALE ENTRANCE	G	Never Contaminated	Demolish
GATEHOUSE, WILLISTON ENTRANCE	G	Other Industrial	Demolish
GUARDHOUSE HW 125 - RD. 2	G	Never Contaminated	Demolish
ADMIN BUILDING FOR WASTEWATER TREATMENT EQUIPMENT	G	Never Contaminated	Demolish
100 AREA FIRE STATION	G	Never Contaminated	Demolish
FIRE STATION	G	Never Contaminated	Demolish

Table 4.3b			
*EM Integrated Deactivation and Decommissioning Plan			
*Data consistent w/2004 PMP			
		Risk/Hazard Type	Technology
Name	Area	Conceptual Site Model Hazard / Current Risk	Decommissioning Alternative
ENVIRON. SUPPORT FAC., PAR POND	G	Chemical - Low Hazard	Demolish
GREENHOUSE	G	Never Contaminated	Demolish
LABORATORY FOR UGA	G	Other Industrial	Demolish
GREENHOUSE FOR THERMAL EFFECTS LAB.	G	Never Contaminated	Demolish
INTERIM SANITARY LANDFILL	G	Other Industrial	Demolish
SR ARCHAEOLOGICAL HDQTRS.	G	Never Contaminated	Demolish
DEER HUNT BUILDING	G	Never Contaminated	Demolish
STORAGE BUILDING	G	Never Contaminated	Demolish
ADMINISTRATION FACILITY - FOREST SERVICE	G	Never Contaminated	Demolish
STORAGE SHELTER	G	Never Contaminated	Demolish
HEAVY EQUIPMENT STORAGE SHELTER	G	Other Industrial	Demolish
U.S. FOREST SERVICE HEADQUARTERS	G	Never Contaminated	Demolish
HUNT ASSY. BLDG.	G	Never Contaminated	Demolish
FOREST SERVICE STORAGE BLDG.	G	Never Contaminated	Demolish
SR FOREST STATION EQUIP. BLDG.	G	Never Contaminated	Demolish
U.S. FOREST SERVICE HEADQUARTERS	G	Never Contaminated	Demolish
CORE STORAGE	G	Never Contaminated	Demolish
ECOLOGY RESEARCH LABORATORY ANNEX	G	Never Contaminated	Demolish
STORAGE BUILDING	G	Never Contaminated	Demolish
CORE STORAGE	G	Never Contaminated	Demolish
CORE STORAGE	G	Never Contaminated	Demolish
TREAT EXTRACTED GROUNDWATER	G	Chemical - Low Hazard	Demolish
FRP SURGE CONTNMNT OF INJECTION WATER TANK	G	Other Industrial	Demolish
FRP SURGE CONTNMNT OF EXTRACTED WATER TANK	G	Other Industrial	Demolish

Table 4.3b			
*EM Integrated Deactivation and Decommissioning Plan			
*Data consistent w/2004 PMP			
		Risk/Hazard Type	Technology
Name	Area	Conceptual Site Model Hazard / Current Risk	Decommissioning Alternative
TREAT EXTRACTED GROUNDWATER	G	Chemical - Low Hazard	Demolish
FRP SURGE TANK	G	Other Industrial	Demolish
FRP INJECTION TANK	G	Other Industrial	Demolish
TREMBLER STATION ON C-ROAD	G	Other Industrial	Demolish
TREBLER SAMPLER PIT NO. 4	G	Other Industrial	Demolish
TREBLER SAMPLER, #1 FOR 904-41G(ABANDON)	G	Other Industrial	Demolish
TREBLER SAMPLER, #2 FOR 904-44G(ABANDON)	G	Other Industrial	Demolish
MCC NO. 2	H	Other Industrial	Demolish
15K GAL UNH STORAGE TK ELECT CONTROL RM	H	Other Industrial	Demolish
LEU LOADING STATION	H	Other Industrial	Demolish
CHEMICAL STORAGE BUILDING	H	Other Industrial	Demolish
CONTROL ROOM	H	Other Industrial	Demolish
MCC NO. 1	H	Other Industrial	Demolish
CANYON AUXILIARIES	H	Nuclear	Demolish
STORAGE BUILDING	H	Never Contaminated	Demolish
STORAGE BUILDING	H	Other Industrial	Demolish
STORAGE BUILDING	H	Other Industrial	Demolish
STORAGE BUILDING	H	Other Industrial	Demolish
A LINE	H	Nuclear	Demolish
B-LINE STORAGE BUILDING	H	Other Industrial	Demolish
DECONTAMINATION CELL MAINTENANCE FAC	H	Other Industrial	Demolish
CANYON BUILDING	H	Nuclear	ISD
COLD FEED PREPARATION FACILITY	H	Chemical - Low Hazard	Demolish
MERCURY STORAGE BUILDING	H	Other Industrial	Demolish
WAREHOUSE	H	Never Contaminated	Demolish

Table 4.3b			
*EM Integrated Deactivation and Decommissioning Plan			
*Data consistent w/2004 PMP			
		Risk/Hazard Type	Technology
Name	Area	Conceptual Site Model Hazard / Current Risk	Decommissioning Alternative
SAFEGUARDS & HP SHOP	H	Never Contaminated	Demolish
DEMONSTRATION WASTE INCINERATOR	H	Other Industrial	Demolish
HDB8 FACILITY	H	Nuclear	Demolish
HDB8 HVAC BLDG. FILTER BLDG.	H	Other Industrial	Demolish
OFFICE/WAREHOUSE	H	Nuclear	Demolish
COOLING WATER BASIN	H	Radiological	ISD
INFLUENT PUMP STATION	H	Other Industrial	Demolish
MCC BUILDING	H	Never Contaminated	Demolish
FIRE WATER PUMP HOUSE	H	Other Industrial	Demolish
WEST PUMP HOUSE	H	Other Industrial	Demolish
FIRE SUPPRESSION FOAM HOUSE	H	Other Industrial	Demolish
ETF STORAGE BUILDING	H	Never Contaminated	Demolish
EAST PUMP HOUSE	H	Other Industrial	Demolish
BREATHING AIR COMPRESSOR BLDG.	H	Other Industrial	Demolish
TREATED WATER STORAGE TANK	H	Radiological	Demolish
TREATED WATER STORAGE TANK	H	Radiological	Demolish
TREATED WATER STORAGE TANK	H	Radiological	Demolish
DCS I/O STATION	H	Other Industrial	Demolish
RBA ENTRANCE SHACK TO TKS 9-12	H	Other Industrial	Demolish
RBA ENTRANCE SHACK TO TANKS 29-32 AND 35-37	H	Other Industrial	Demolish
RBA ENTRANCE SHACK TO TANKS 13-16	H	Other Industrial	Demolish
RBA ENTRANCE SHACK TO PUMP PIT 5 & 6	H	Other Industrial	Demolish
EPVE STORAGE BUILDING	H	Nuclear	Demolish
NITROGEN STORAGE FACILITY	H	Other Industrial	Demolish

Table 4.3b			
*EM Integrated Deactivation and Decommissioning Plan			
*Data consistent w/2004 PMP			
		Risk/Hazard Type	Technology
Name	Area	Conceptual Site Model Hazard / Current Risk	Decommissioning Alternative
PORTABLE GANG VALVE HOUSE	H	Other Industrial	Demolish
STORM WATER DIVERSION BOX	H	Other Industrial	ISD
STORM WATER DIVERSION BOX	H	Other Industrial	ISD
DIVERSION BOX	H	Other Industrial	ISD
2H CONTROL ROOM & OFFICE BUILDING	H	Nuclear	Demolish
COOLING TOWER FOR EVAP #2	H	Other Industrial	Demolish
3H CONTROL ROOM & OFFICE BUILDING	H	Nuclear	Demolish
DB#7 AND GANG VALVE HOUSE	H	Nuclear	ISD
COLD FEEDS AREA	H	Nuclear	Demolish
IX/RO/EVAPORATOR OH TANK CONTAINMENT	H	Radiological	Demolish
HDB-2	H	Nuclear	ISD
EVAPORATOR CONDENSER TANK CONTAINMENT	H	Radiological	Demolish
EVAPORATOR FEED TANK	H	Radiological	Demolish
HDB-3	H	Nuclear	ISD
FAR EAST PUMP HOUSE	H	Other Industrial	Demolish
DIVERSION BOX DB#5	H	Nuclear	ISD
HVAC HEPA CONTAINMENT	H	Radiological	Demolish
HDB-6	H	Nuclear	ISD
LAUNDRY BUILDING	H	Other Industrial	Demolish
MAINTENANCE AND E & I SHOP	H	Other Industrial	Demolish
MOTOR CONTROL CENTER	H	Other Industrial	Demolish
PROCESS AIR COMPRESSOR BUILDING	H	Other Industrial	Demolish
MAINTENANCE OFFICE BUILDING	H	Never Contaminated	Demolish
PROCESS PUMP PIT FOR NEW WASTE HEADER	H	Nuclear	ISD

Table 4.3b			
*EM Integrated Deactivation and Decommissioning Plan			
*Data consistent w/2004 PMP			
		Risk/Hazard Type	Technology
Name	Area	Conceptual Site Model Hazard / Current Risk	Decommissioning Alternative
2H EVAPORATOR	H	Nuclear	Demolish
CTS - H-AREA	H	Nuclear	Demolish
1H CONTROL ROOM BUILDING	H	Nuclear	Demolish
OFFICE/LUNCH ROOM BUILDING	H	Never Contaminated	Demolish
3H EVAPORATOR CONNECTED WITH 242-11H SERVICE BLD	H	Nuclear	Demolish
ELECTRICAL CONTROL ROOM/PVS HEPA BUILDING	H	Other Industrial	Demolish
1H EVAPORATOR	H	Nuclear	Demolish
RBOF STORAGE BUILDING	H	Other Industrial	Demolish
RECEIVING BASIN FOR OFF-SITE FUEL	H	Nuclear	ISD
PARKING AREA / REGENERATION ACTIVITIES	H	Chemical - Low Hazard	Demolish
RESIN REGENERATION BUILDING	H	Nuclear	Demolish
PRIMARY SUBSTATION (HIGH VOLTAGE 115KV)	H	Other Industrial	Demolish
TRANSFORMER	H	Other Industrial	Demolish
RADIOLOGICAL MONITORING EQUIPMENT SHOP	H	Other Industrial	Demolish
DIESEL GENERATOR FOR 241-2H	H	Other Industrial	Demolish
DIESEL GENERATOR BUILDING FOR CANYON EXHAUST	H	Other Industrial	Demolish
DIESEL HOUSE	H	Nuclear	Demolish
HAZARDOUS WASTE INCINERATOR	H	Radiological	Demolish
CIF TANK FARM	H	Radiological	Demolish
BASIN	H	Nuclear	Demolish
FILTER AND DEIONIZER FACILITY	H	Other Industrial	Demolish
COOLING WATER MONITOR HOUSE	H	Nuclear	Demolish
COOLING WATER MONITOR HOUSE	H	Nuclear	Demolish
COOLING WATER MONITOR HOUSE	H	Nuclear	Demolish

Table 4.3b			
*EM Integrated Deactivation and Decommissioning Plan			
*Data consistent w/2004 PMP			
		Risk/Hazard Type	Technology
Name	Area	Conceptual Site Model Hazard / Current Risk	Decommissioning Alternative
COOLING WATER MONITOR HOUSE	H	Nuclear	Demolish
COOLING WATER MONITOR HOUSE	H	Nuclear	Demolish
COOLING WATER MONITOR HOUSE	H	Nuclear	Demolish
RETURN WATER DELAYING BASIN	H	Nuclear	ISD
RETURN WATER PUMPING BASIN	H	Nuclear	ISD
MONITORING HOUSE	H	Nuclear	Demolish
SEGREGATED WATER DELAYING BASIN	H	Nuclear	ISD
MONITORING HOUSE	H	Nuclear	Demolish
STORAGE BASIN, 4 MILLION GALLON, LINED	H	Radiological	ISD
RESERVOIR AND PUMP HOUSE	H	Other Industrial	ISD
COAL HANDLER OBSERVATION BUILDING	H	Other Industrial	Demolish
MAINTENANCE LAYDOWN BUILDING	H	Other Industrial	Demolish
POWERHOUSE	H	Other Industrial	Demolish
COOLING TOWERS & CHEMICAL ADDITION BUILDING	H	Other Industrial	Demolish
COOLING TOWER	H	Other Industrial	ISD
CANYON STACK	H	Radiological	Demolish
VESSEL VENT FAN HOUSE	H	Radiological	ISD
FAN HOUSE BUILDING	H	Radiological	Demolish
STACK MONITORING EQUIPMENT BUILDING	H	Nuclear	Demolish
CANYON EXHAUST FAN HOUSE	H	Radiological	Demolish
ADDITIONAL CANYON SAND FILTER	H	Nuclear	ISD
CANYON EXHAUST FILTERS	H	Nuclear	ISD
AIR COMPRESSOR BUILDING	H	Other Industrial	Demolish
STORAGE/SUPPLY BUILDING	H	Nuclear	Demolish

Table 4.3b			
*EM Integrated Deactivation and Decommissioning Plan			
*Data consistent w/2004 PMP			
		Risk/Hazard Type	Technology
Name	Area	Conceptual Site Model Hazard / Current Risk	Decommissioning Alternative
CRANE SHELTER	H	Other Industrial	Demolish
MAINTENANCE FACILITY	H	Nuclear	Demolish
CHEMICAL FEED FACILITY	H	Other Industrial	Demolish
LIFT STATION	H	Radiological	ISD
SOLVENT TANK	H	Nuclear	Demolish
SOLVENT TANK	H	Nuclear	Demolish
SOLVENT TANK	H	Nuclear	Demolish
SOLVENT TANK	H	Nuclear	Demolish
H-AREA PUMP STATION FOR WASTEWATER TREATMENT FAC	H	Other Industrial	Demolish
GUARDHOUSE	H	Other Industrial	Demolish
SOUTH GATE GUARD SHACK	H	Other Industrial	Demolish
PATROL HEADQUARTERS	H	Other Industrial	Demolish
WEST BADGE HOUSE	H	Other Industrial	Demolish
GATE "Q" ECF	H	Other Industrial	Demolish
ENTRY CONTROL FACILITY (FOR HTF AREA)	H	Other Industrial	Demolish
GATEHOUSE ENTRANCE TO 232-H & 234-H	H	Other Industrial	Demolish
TELEPHONE EXCHANGE BUILDING	H	Other Industrial	Demolish
OFFICE BUILDING	H	Other Industrial	Demolish
ADMINISTRATION BUILDING	H	Other Industrial	Demolish
CONSTRUCTION ADMINISTRATION OFFICE	H	Other Industrial	Demolish
OFFICE BUILDING	H	Other Industrial	Demolish
AREA ADMINISTRATION & SERVICE BUILDING	H	Other Industrial	Demolish
TRAINING BUILDING	H	Other Industrial	Demolish

Table 4.3b			
*EM Integrated Deactivation and Decommissioning Plan			
*Data consistent w/2004 PMP			
		Risk/Hazard Type	Technology
Name	Area	Conceptual Site Model Hazard / Current Risk	Decommissioning Alternative
OFFICE BUILDING	H	Other Industrial	Demolish
OFFICE BUILDING	H	Other Industrial	Demolish
MEDICAL FACILITY	H	Other Industrial	Demolish
CENTRAL ALARM STATION (CAS)	H	Other Industrial	Demolish
OFFICE, SHOP & STORAGE BUILDING	H	Other Industrial	Demolish
SRS CENTRAL TRAINING FACILITY	H	Other Industrial	Demolish
PRE-FABRICATED BUILDING	H	Other Industrial	Demolish
PUMP HOUSE	H	Other Industrial	Demolish
FIRE WATER PUMP HOUSE	H	Other Industrial	Demolish
DEEP WELL	H	Other Industrial	ISD
HEAVY WATER STORAGE FACILITY	K	Nuclear	Demolish
NO. 1&4 BASIN DEIONIZERS (POR) PAD FAC	K	Other Industrial	Demolish
DISASSEMBLY BASIN FILTRATION FAC.	K	Other Industrial	Demolish
REACTOR BUILDING	K	Nuclear	ISD
COOLING WATER EFFLUENT SUMP	K	Other Industrial	ISD
ENGINE HOUSE	K	Other Industrial	ISD
ENGINE HOUSE	K	Other Industrial	ISD
PRIMARY SUBSTATION (HIGH VOLT 115/13.8)	K	Other Industrial	ISD
PRIMARY SUBSTATION (HIGH VOLT 115/13.8)	K	Other Industrial	ISD
FILTER AND SOFTENER PLANT	K	Other Industrial	Demolish
DIESEL GENERATOR CONTROL BUILDING	K	Other Industrial	Demolish
CLARIFICATION PLANT (MISC. SERVICES)	K	Other Industrial	Demolish
SHELTER FOR DIESEL FUEL OIL STRG TANK NO. 1	K	Other Industrial	Demolish
POWERHOUSE	K	Other Industrial	Demolish

Table 4.3b			
*EM Integrated Deactivation and Decommissioning Plan			
*Data consistent w/2004 PMP			
		Risk/Hazard Type	Technology
Name	Area	Conceptual Site Model Hazard / Current Risk	Decommissioning Alternative
COOLING TOWER	K	Other Industrial	ISD
COOLING TOWER	K	Other Industrial	Demolish
SODIUM HYPOCHLORITE TANK STORAGE	K	Other Industrial	Demolish
COOLING WATER RESERVOIR	K	Other Industrial	ISD
COOLING WATER PUMP HOUSE	K	Other Industrial	ISD
PUMP HOUSE-REACTOR FIRE WATER SYSTEM	K	Other Industrial	Demolish
PUMP HOUSE-DOMESTIC & FIRE WATER SYSTEM	K	Other Industrial	Demolish
CHEMICAL FEED BUILDING	K	Other Industrial	Demolish
DIVERSION BOX	K	Other Industrial	ISD
EFFLUENT MONITORING BUILDING	K	Other Industrial	Demolish
AREA GATEHOUSE & PATROL HQ.	K	Other Industrial	Demolish
GATEHOUSE ENTRANCE AT BLDG. 105	K	Other Industrial	Demolish
TELEPHONE EXCHANGE BUILDING	K	Other Industrial	Demolish
AREA ADM. & SERVICES BUILDING	K	Never Contaminated	Demolish
ADMINISTRATIVE OFFICE FACILITY	K	Never Contaminated	Demolish
MAINTENANCE MATERIAL STORAGE BLDG.	K	Never Contaminated	Demolish
LUMBER STORAGE SHED	K	Other Industrial	Demolish
VIDEO-SAFEGUARDS MAINTENANCE FACILITY	K	Other Industrial	Demolish
POLYPHOSPHATE UNLOADING AND STORAGE FACILITY	K	Chemical - Low Hazard	Demolish
DOMESTIC WATER ELEVATED STORAGE TANK	K	Never Contaminated	Demolish
L-REACTOR DISASSEMBLY BASIN DEIONIZER SYSTEM	L	Other Industrial	Demolish
SETTLER TANK & FILTERS AREA	L	Other Industrial	Demolish
REACTOR BUILDING	L	Nuclear	ISD
COOLING WATER EFFLUENT SUMP	L	Radiological	Demolish

Table 4.3b			
*EM Integrated Deactivation and Decommissioning Plan			
*Data consistent w/2004 PMP			
		Risk/Hazard Type	Technology
Name	Area	Conceptual Site Model Hazard / Current Risk	Decommissioning Alternative
ENGINE HOUSE	L	Other Industrial	ISD
ENGINE HOUSE	L	Other Industrial	ISD
EMERG DIESEL GENER & FUEL OIL STORAGE	L	Other Industrial	Demolish
HELIUM STORAGE TANK	L	Other Industrial	Demolish
PRIMARY SUBSTATION (HIGH VOLT 115/13.8)	L	Other Industrial	ISD
PRIMARY SUBSTATION (HIGH VOLT 115/13.8)	L	Other Industrial	ISD
GENERATOR ROOM	L	Other Industrial	Demolish
FILTER AND SOFTENER PLANT	L	Other Industrial	Demolish
DIESEL GENERATOR CONTROL BUILDING	L	Other Industrial	Demolish
CLARIFICATION PLANT (MISC. SERVICES)	L	Other Industrial	Demolish
STORAGE BUILDING	L	Other Industrial	Demolish
COOLING WATER RESERVOIR	L	Other Industrial	ISD
COOLING WATER PUMP HOUSE	L	Other Industrial	ISD
STANDBY PUMP HOUSE	L	Other Industrial	Demolish
CHEMICAL STORAGE BUILDING	L	Other Industrial	Demolish
EFFLUENT MONITORING BUILDING	L	Other Industrial	Demolish
AREA GATEHOUSE & PATROL HQ.	L	Other Industrial	Demolish
GATEHOUSE ENTRANCE AT BLDG. 105	L	Other Industrial	Demolish
TELEPHONE EXCHANGE BUILDING	L	Other Industrial	Demolish
AREA ADM. & SERVICES BUILDING	L	Other Industrial	Demolish
MAINTENANCE MATERIAL STORAGE BLDG.	L	Other Industrial	Demolish
CLOTHING CHANGE FACILITY	L	Other Industrial	Demolish
CLOTHING CHANGE FACILITY	L	Other Industrial	Demolish
CLOTHING CHANGE FACILITY	L	Other Industrial	Demolish

Table 4.3b			
*EM Integrated Deactivation and Decommissioning Plan			
*Data consistent w/2004 PMP			
		Risk/Hazard Type	Technology
Name	Area	Conceptual Site Model Hazard / Current Risk	Decommissioning Alternative
SWP CLOTHING BUILDING	L	Other Industrial	Demolish
CONTAMINATED LAUNDRY STORAGE BLDG.	L	Other Industrial	Demolish
CANNING BUILDING	M	Other Industrial	Demolish
HAZARDOUS MIXED WASTE STORAGE PAD	M	Radiological	Demolish
ESSENTIAL MATERIALS WAREHOUSE	M	Other Industrial	Demolish
CHEMICAL STORAGE PAD	M	Other Industrial	Demolish
DRUM STORAGE FACILITY	M	Radiological	Demolish
ALLOY BUILDING	M	Other Industrial	Demolish
MANUFACTURING BUILDING	M	Other Industrial	Demolish
METALLURGICAL LABORATORY	M	Other Industrial	Demolish
MCC FOR GROUND WATER TREATMENT	M	Other Industrial	Demolish
VERTICAL PRESS BUILDING	M	Other Industrial	Demolish
CORE STORAGE WAREHOUSE	M	Other Industrial	Demolish
LAB WASTE TREATMENT FACILITY	M	Other Industrial	Demolish
SLUG WAREHOUSE	M	Other Industrial	Demolish
TANK FARM CONTAINMENT COVER	M	Other Industrial	Demolish
VENDOR TREATMENT FACILITY	M	Other Industrial	Demolish
DILUTE EFFLUENT TREATMENT FACILITY	M	Other Industrial	Demolish
ELECTRICAL STORAGE BUILDING (FORMERLY MS4	M	Other Industrial	Demolish
ELECTRICAL STORAGE BUILDING (FORMERLY MS5)	M	Other Industrial	Demolish
MAIN GATEHOUSE	M	Other Industrial	Demolish
HARDEN ENTRY CONTROL FACILITY TO 321-M	M	Other Industrial	Demolish
AREA ADMINISTRATION BUILDING	M	Other Industrial	Demolish
ENGINEERING & TRAINING BUILDING	M	Other Industrial	Demolish

Table 4.3b			
*EM Integrated Deactivation and Decommissioning Plan			
*Data consistent w/2004 PMP			
		Risk/Hazard Type	Technology
Name	Area	Conceptual Site Model Hazard / Current Risk	Decommissioning Alternative
PUMP HOUSE	M	Other Industrial	Demolish
ICE HOUSE	N	Never Contaminated	Demolish
CHEMICAL FEED FACILITY	N	Other Industrial	Demolish
TREATMENT FACILITY	N	Other Industrial	Demolish
SRS CENTRAL CLIMATOLOGY DATA STATION	N	Never Contaminated	Demolish
ADMINISTRATION BUILDING	N	Never Contaminated	Demolish
INTERIM STORAGE FAC	N	Nuclear	Demolish
SOLID HAZARDOUS WASTE STORAGE BLDG	N	Nuclear	Demolish
STOR FAC FOR NON-RADIOACTIVE HAZ WASTE	N	Nuclear	Demolish
SEC TRANS SUBSTATION	N	Other Industrial	Demolish
PUMP HOUSE	N	Other Industrial	Demolish
PROCESS HEAT EXCHANGER REPAIR FAC	N	Other Industrial	Demolish
SRQA BUILDING, C/S	N	Never Contaminated	Demolish
CONCRETE OFFICE	N	Never Contaminated	Demolish
C/S CAB BUILDING	N	Never Contaminated	Demolish
MILLER DUNN ELECTRIC BUILDING	N	Never Contaminated	Demolish
CONSTRUCTION ADMINISTRATION BUILDING	N	Never Contaminated	Demolish
ADMINISTRATION BUILDING	N	Other Industrial	Demolish
HEAVY EQUIP STORAGE SHED	N	Never Contaminated	Demolish
ADMINISTRATION BUILDING	N	Other Industrial	Demolish
CABLE SHED	N	Never Contaminated	Demolish
TIRE STORAGE CANOPY	N	Never Contaminated	Demolish
EQUIPMENT SHED	N	Never Contaminated	Demolish
STORAGE SHED	N	Never Contaminated	Demolish

Table 4.3b			
*EM Integrated Deactivation and Decommissioning Plan			
*Data consistent w/2004 PMP			
		Risk/Hazard Type	Technology
Name	Area	Conceptual Site Model Hazard / Current Risk	Decommissioning Alternative
FLAMMABLE STORAGE	N	Chemical - Low Hazard	Demolish
STORAGE BUILDING	N	Never Contaminated	Demolish
HAZARDOUS WASTE STORAGE	N	Other Industrial	Demolish
HE OIL STORAGE BUILDING	N	Other Industrial	Demolish
STORAGE SHED	N	Never Contaminated	Demolish
MACH. AND M.W. OIL STORAGE	N	Other Industrial	Demolish
EXCESS STORAGE	N	Never Contaminated	Demolish
PIPE, NPC OFFICES-ELECTRICAL SHOP	N	Other Industrial	Demolish
SPECIAL PROJECTS-ADDN.	N	Never Contaminated	Demolish
PIPE WAREHOUSE	N	Other Industrial	Demolish
PLUMBING MAINTENANCE AREA	N	Never Contaminated	Demolish
X-RAY	N	Other Industrial	Demolish
MECHANICAL SHOP	N	Other Industrial	Demolish
PIPE AND MECHANICAL SHOP	N	Other Industrial	Demolish
A WAREHOUSE, CMR, ISC CONTROL #31	N	Other Industrial	Demolish
DOUBLE BAY WAREHOUSE FOR S-AREA	N	Chemical - Low Hazard	Demolish
WAREHOUSE FOR S-AREA	N	Never Contaminated	Demolish
B WAREHOUSE, C/S	N	Never Contaminated	Demolish
SPARE EQUIPMENT STORAGE	N	Other Industrial	Demolish
REACTOR COMPONENT STORAGE	N	Never Contaminated	Demolish
MISCELLANEOUS STORAGE (SYLCOR)	N	Never Contaminated	Demolish
SEPARATIONS PROCESS STORAGE	N	Nuclear	Demolish
STORAGE BUILDING	N	Never Contaminated	Demolish
BULK FUEL FACILITY	N	Other Industrial	Demolish

Table 4.3b			
*EM Integrated Deactivation and Decommissioning Plan			
*Data consistent w/2004 PMP			
		Risk/Hazard Type	Technology
Name	Area	Conceptual Site Model Hazard / Current Risk	Decommissioning Alternative
NEW STEAM CLEANING	N	Other Industrial	Demolish
HEAVY EQUIPMENT WASH AREA	N	Never Contaminated	Demolish
GARAGE, SVC STATION, COMPRESSOR HOUSE	N	Other Industrial	Demolish
WAREHOUSE AND INSULATION SHOP	N	Never Contaminated	Demolish
ELECTRICAL LINEMEN'S OFFICE/WAREHOUSE	N	Never Contaminated	Demolish
CONSTRUCTION SORT BUILDING	N	Never Contaminated	Demolish
CONST ENV STAGING BUILDING	N	Other Industrial	Demolish
RECLAIMING BUILDING	N	Other Industrial	Demolish
BOILERMAKER SHOP	N	Other Industrial	Demolish
SMALL TOOL REPAIR SHOP	N	Never Contaminated	Demolish
SHEET METAL SHOP	N	Other Industrial	Demolish
PTL., INST., QA & WAREHOUSE	N	Never Contaminated	Demolish
CARPENTER SHOP AND OFFICE	N	Never Contaminated	Demolish
LAYOUT, T&I OFFICES, WELD TEST	N	Never Contaminated	Demolish
SIW SHOP	N	Other Industrial	Demolish
CONSTRUCTION EMPLOYMENT BUILDING	N	Never Contaminated	Demolish
PROPERTY MANAGEMENT	N	Other Industrial	Demolish
E&I SHOP	N	Other Industrial	Demolish
A SAND BLAST SHED	N	Other Industrial	Demolish
PAINT SHED	N	Other Industrial	Demolish
PAINT	N	Other Industrial	Demolish
COAL SAMPLING FACILITY	N	Other Industrial	Demolish
CASK REPAIR FACILITY	N	Other Industrial	Demolish
FURNITURE STORAGE WAREHOUSE	N	Never Contaminated	Demolish

Table 4.3b			
*EM Integrated Deactivation and Decommissioning Plan			
*Data consistent w/2004 PMP			
		Risk/Hazard Type	Technology
Name	Area	Conceptual Site Model Hazard / Current Risk	Decommissioning Alternative
RECEIVING FACILITY-MAT'L RECEV & STOR FAC	N	Never Contaminated	Demolish
BULK STRG WHSE-MAT'L MGMT RECV & STOR FAC	N	Never Contaminated	Demolish
SPARE PARTS WHSE-MAT'L MGMT RECV & STOR FAC	N	Never Contaminated	Demolish
GENERAL STORES WAREHOUSE	N	Never Contaminated	Demolish
FLAMMABLE MATERIAL STORAGE	N	Chemical - Low Hazard	Demolish
COMPRESSED GAS STORAGE	N	Other Industrial	Demolish
ASSET SUPPORT GROUP BUILDING	N	Never Contaminated	Demolish
PCB STORAGE FACILITY	N	Nuclear	Demolish
USED DRUM AND BATTERY STORAGE	N	Other Industrial	Demolish
SALVAGE AND RECLAMATION BUILDING	N	Other Industrial	Demolish
STORAGE BUILDING	N	Never Contaminated	Demolish
STORAGE BUILDING	N	Never Contaminated	Demolish
HEAVY WATER STORAGE FACILITY	P	Other Industrial	Demolish
REACTOR BUILDING	P	Radiological	ISD
COOLING WATER EFFLUENT SUMP	P	Other Industrial	ISD
ENGINE HOUSE	P	Other Industrial	ISD
ENGINE HOUSE	P	Other Industrial	ISD
PRIMARY SUBSTATION (HIGH VOLT 115/13.8)	P	Other Industrial	ISD
PRIMARY SUBSTATION (HIGH VOLT 115/13.8)	P	Other Industrial	ISD
GENERATOR ROOM	P	Other Industrial	Demolish
FILTER AND SOFTENER PLANT	P	Other Industrial	Demolish
CLARIFICATION PLANT (MISC. SERVICES)	P	Other Industrial	Demolish
SODIUM HYPOCHLORITE TANK STORAGE	P	Other Industrial	Demolish
COOLING WATER RESERVOIR	P	Other Industrial	ISD

Table 4.3b			
*EM Integrated Deactivation and Decommissioning Plan			
*Data consistent w/2004 PMP			
		Risk/Hazard Type	Technology
Name	Area	Conceptual Site Model Hazard / Current Risk	Decommissioning Alternative
COOLING WATER PUMP HOUSE	P	Other Industrial	ISD
CHEMICAL FEED FACILITY	P	Other Industrial	Demolish
EQUALIZATION BASIN	P	Other Industrial	ISD
EFFLUENT MONITORING BUILDING	P	Other Industrial	Demolish
AREA GATEHOUSE & PATROL HQ.	P	Other Industrial	Demolish
GATEHOUSE ENTRANCE AT BLDG. 105	P	Other Industrial	Demolish
TELEPHONE EXCHANGE BUILDING	P	Other Industrial	Demolish
AREA ADM. & SERVICES BUILDING	P	Other Industrial	Demolish
REACTOR BUILDING (STANDBY)	R	Nuclear	ISD
ENGINE HOUSE (STANDBY)	R	Other Industrial	ISD
ENGINE HOUSE (STANDBY)	R	Other Industrial	ISD
PURGE WATER STORAGE BASIN (IN STANDBY)	R	Radiological	ISD
PROCESS STORAGE BUILDING	R	Nuclear	Demolish
PRIMARY SUBSTATION (HIGH VOLT 115/13.8)	R	Other Industrial	ISD
PRIMARY SUBSTATION (HIGH VOLT 115/13.8)	R	Other Industrial	ISD
CLARIFICATION PLANT(COOLING WATER)	R	Other Industrial	ISD
FILTER AND SOFTENER PLANT (STANDBY)	R	Other Industrial	ISD
COOLING WATER RESERVOIR (STANDBY)	R	Other Industrial	ISD
COOLING WATER PUMP HOUSE (STANDBY)	R	Other Industrial	ISD
SERVICE BUILDING	S	Nuclear	Demolish
VITRIFICATION BUILDING	S	Nuclear	ISD
SPARE EQUIPMENT STORAGE BUILDING	S	Other Industrial	Demolish
PORTABLE STORAGE BUILDING	S	Other Industrial	Demolish
GLASS WASTE STORAGE BUILDING	S	Nuclear	Demolish

Table 4.3b			
*EM Integrated Deactivation and Decommissioning Plan			
*Data consistent w/2004 PMP			
		Risk/Hazard Type	Technology
Name	Area	Conceptual Site Model Hazard / Current Risk	Decommissioning Alternative
CRANE CONTROL BUILDING	S	Nuclear	Demolish
VENT EXHAUST STACK	S	Nuclear	Demolish
FAN HOUSE	S	Nuclear	Demolish
SAND FILTER	S	Nuclear	ISD
BULK FRIT FACILITY	S	Nuclear	Demolish
COLD FEED STORAGE	S	Nuclear	Demolish
REF ORGANIC RECOVERY UNIT	S	Other Industrial	Demolish
ORGANIC WASTE STORAGE FAC	S	Nuclear	Demolish
LOW POINT PUMP PIT HVAC	S	Other Industrial	Demolish
INSTRUMENT SHELTER BUILDING	S	Other Industrial	Demolish
LOW POINT PUMP PIT	S	Nuclear	Demolish
LATE WASH FACILITY HVAC BUILDING	S	Other Industrial	Demolish
LATE WASH LABORATORY	S	Nuclear	Demolish
LATE WASH COLD CHEMICAL FEED SHELTER	S	Nuclear	Demolish
LATE WASH FACILITY	S	Nuclear	Demolish
S-AREA PUMP STATION FOR WASTEWATER TREATMENT FAC	S	Other Industrial	ISD
ENTRY CONTROL FACILITY	S	Other Industrial	Demolish
TELEPHONE BUILDING	S	Other Industrial	Demolish
CYLINDER STORAGE SHELTER	S	Other Industrial	Demolish
TC-S1 ADMINISTRATION BLDG	S	Other Industrial	Demolish
TC-S2 RECEIVING STORES	S	Other Industrial	Demolish
OPERATIONS BUILDING	S	Other Industrial	Demolish
DISTRIBUTIVE CONTROL STAGING BUILDING	S	Other Industrial	Demolish

Table 4.3b			
*EM Integrated Deactivation and Decommissioning Plan			
*Data consistent w/2004 PMP			
		Risk/Hazard Type	Technology
Name	Area	Conceptual Site Model Hazard / Current Risk	Decommissioning Alternative
MAINTENANCE SHOP	S	Other Industrial	Demolish
SPARE PARTS BUILDING	S	Other Industrial	Demolish
TC-S7 LAB SUPPORT FAC. (FORMERLY 717012 N)	S	Other Industrial	Demolish
TC-S3 PIPE SHOP	S	Other Industrial	Demolish
TC-S5 ELECTRICAL SHOP	S	Other Industrial	Demolish
LUBRICATION STORAGE BUILDING	S	Other Industrial	Demolish
OFFICE BUILDING & MAINTENANCE SHOP	S	Other Industrial	Demolish
CHEMICAL STORAGE BUILDING	S	Other Industrial	Demolish
SWIRL CELL FACILITY	S	Other Industrial	Demolish
SWIRL CELL FACILITY	S	Radiological	Demolish
PRIMARY SUBSTATION	S	Nuclear	Demolish
TRANSFORMER 952-7S	S	Other Industrial	Demolish
FUEL OIL STORAGE	S	Other Industrial	Demolish
NEUTRALIZED FIRE WATER TANK	S	Other Industrial	Demolish
WATER & CHEMICAL WASTE TREATMENT FAC	S	Nuclear	Demolish
CHEMICAL TREATMENT FAC	S	Other Industrial	Demolish
COOLING TOWER	S	Nuclear	Demolish
DWPF SEMI-WORKS BUILDING	T	Other Industrial	Demolish
PILOT PLANT BUILDING	T	Other Industrial	Demolish
SEMI WORKS WASTE TANK MOCK-UP	T	Other Industrial	Demolish
CHEMICAL SEMI WORKS BLDG (TNX)	T	Other Industrial	Demolish
ENGINEERING TEST FAC. (CMX)	T	Other Industrial	Demolish
TNX PACKAGED SANITARY WASTE TREAT PLANT	T	Other Industrial	Demolish
TNX SANITARY WASTE CHEMICAL FEED BLDG.	T	Other Industrial	Demolish

Table 4.3b			
*EM Integrated Deactivation and Decommissioning Plan			
*Data consistent w/2004 PMP			
		Risk/Hazard Type	Technology
Name	Area	Conceptual Site Model Hazard / Current Risk	Decommissioning Alternative
ORGANIC REMOVAL FACILITY	T	Other Industrial	Demolish
SECONDARY TRANS. SUBSTATION #3, TNX	T	Other Industrial	Demolish
SERVICE TANK AGE FACILITIES, TNX	T	Other Industrial	Demolish
CONTAINERIZATION EQUIPMENT DEV FAC TNX	T	Other Industrial	Demolish
CHEMICAL STORAGE FACILITY, TNX	T	Other Industrial	Demolish
PUMP HOUSE	T	Other Industrial	Demolish
TNX EFFLUENT TREATMENT PLANT	T	Other Industrial	Demolish
MANUFACTURING BUILDING	T	Other Industrial	Demolish
SOLVENT STORAGE BUILDING	T	Other Industrial	Demolish
ECR/ICR BUILDING	T	Other Industrial	Demolish
CARPENTER SHOP	T	Other Industrial	Demolish
CONSTRUCTION BUILDING	T	Other Industrial	Demolish
TNX ADMINISTRATION BLDG. ANNEX	T	Other Industrial	Demolish
BECHTEL OFFICE BUILDING	T	Other Industrial	Demolish
TNX AREA ADMINISTRATION BLDG.	T	Other Industrial	Demolish
MECHANICAL SERVICES BLDG. TNX	T	Other Industrial	Demolish
CONSOLIDATED LAB	T	Other Industrial	Demolish
GLASS MELTER BUILDING	T	Other Industrial	Demolish
TELECOMMUNICATION BUILDING	T	Other Industrial	Demolish
TEST REACTOR BLDG. (HWCTR)	U	Other Industrial	Demolish
SSHT/FWRT PITS & PAD	Z	Nuclear	Demolish
FLYASH SILO #1	Z	Other Industrial	Demolish
FLYASH SILO #2	Z	Other Industrial	Demolish
FLYASH SILO #3	Z	Other Industrial	Demolish

Table 4.3b *EM Integrated Deactivation and Decommissioning Plan *Data consistent w/2004 PMP			
		Risk/Hazard Type	Technology
Name	Area	Conceptual Site Model Hazard / Current Risk	Decommissioning Alternative
CEMENT SILO	Z	Other Industrial	Demolish
UNLOADING SHED	Z	Other Industrial	Demolish
UNLOADING OFFICE	Z	Other Industrial	Demolish
PROCESS	Z	Nuclear	Demolish
VAULT NO. 1	Z	Nuclear	ISD
VAULT NO. 4	Z	Nuclear	ISD
SALTSTONE OPERATIONS BUILDING	Z	Other Industrial	Demolish
FIRE WATER PUMP HOUSE	Z	Other Industrial	Demolish
ELECT. SUBSTATION	Z	Other Industrial	Demolish
DOMESTIC WATER TANK	Z	Other Industrial	Demolish

Table 4.4a* ESV Hazard Type Crosswalk for Area "TO GO" Units											
Facility Area	Waste Unit Group (Hazard Type)										
	1 Burial Ground Complex	2 Radiological Seepage Basins and Pits	3 Coal Pile Runoff Basins and Ash Basins	4 Inactive Process Sewer Lines	5 Nonradiological Rubble Piles and Pits	6 Nonradiological Seepage Basins	7 Sludge Application Sites	8 Acid/Caustic Basins	9 Miscellaneous Sites	10 Groundwater	11 Integrator Operable Units
E	18									103	
E	20										
G	(Refer to Watershed Tables for G Area Units)										
F		280	277	141					43	19	
F		283	276	308					263	575	
F									266		
F									270		
F									376		
F									380		
F									381		
F									399		
F									411		
F									418		
F									431		
F									432		
F									438		
F									442		
F									490		
F									343		
F									394		

Table 4.4a*											
ESV Hazard Type Crosswalk for Area "TO GO" Units											
*Data consistent w/2004 PMP											
Facility Area	Waste Unit Group (Hazard Type)										
	1 Burial Ground Complex	2 Radiological Seepage Basins and Pits	3 Coal Pile Runoff Basins and Ash Basins	4 Inactive Process Sewer Lines	5 Nonradiological Rubble Piles and Pits	6 Nonradiological Seepage Basins	7 Sludge Application Sites	8 Acid/Caustic Basins	9 Miscellaneous Sites	10 Groundwater	11 Integrator Operable Units
F									414		
F									429		
F									435		
F									485		
H		293	292	554					225	549	
H		294	79	142					261		
H		295							262		
H		298							264		
H		27							274		
H		28							275		
H		29							332		
H									375		
H									383		
H									390		
H									403		
H									412		
H									423		
H									459		
H									260		
H									344		
H									346		

Table 4.4a*											
ESV Hazard Type Crosswalk for Area "TO GO" Units											
*Data consistent w/2004 PMP											
Facility Area	Waste Unit Group (Hazard Type)										
	1 Burial Ground Complex	2 Radiological Seepage Basins and Pits	3 Coal Pile Runoff Basins and Ash Basins	4 Inactive Process Sewer Lines	5 Nonradiological Rubble Piles and Pits	6 Nonradiological Seepage Basins	7 Sludge Application Sites	8 Acid/Caustic Basins	9 Miscellaneous Sites	10 Groundwater	11 Integrator Operable Units
N					57	77			354		
N					58				82		
N					59						
N					244						
N					309						
N					502						
N					311						
N					525						
P		316	313	557	477					143	
P		314	547		108						
P		317									
P		318									
P		319									
P		462									
R		42	329	271	116				230	288	
R		330		556	117				231		
R		119			118				312		
R		120			233				324		
R		121			478				513		

Table 4.4a*
ESV Hazard Type Crosswalk for Area "TO GO" Units

*Data consistent w/2004 PMP

Facility Area	Waste Unit Group (Hazard Type)										
	1 Burial Ground Complex	2 Radiological Seepage Basins and Pits	3 Coal Pile Runoff Basins and Ash Basins	4 Inactive Process Sewer Lines	5 Nonradiological Rubble Piles and Pits	6 Nonradiological Seepage Basins	7 Sludge Application Sites	8 Acid/Caustic Basins	9 Miscellaneous Sites	10 Groundwater	11 Integrator Operable Units
R		122							517		
R		123									
R		124									
T		104		310					127	25	
T		106		559					467		
T		139							500		

APPENDIX K**CONCEPTUAL SITE MODELS FOR TYPICAL HAZARDS**

Figure 4.23b	Generic Conceptual Site Model
Figure 4.24b	Group 1: Burial Ground Complex CSM
Figure 4.25b	Group 1: Burial Ground Complex (continued) CSM
Figure 4.26b	Group 2: Radiological Seepage Basins and Pits CSM
Figure 4.27b	Group 3: Coal Pile Runoff Basins and Ash Basins CSM
Figure 4.28b	Group 4: Inactive Process Sewer Lines CSM
Figure 4.29b	Group 5: Nonradiological Rubble Piles and Pits CSM
Figure 4.30b	Group 6: Nonradiological Seepage Basins CSM
Figure 4.31b	Group 7: Sludge Application Sites CSM
Figure 4.32b	Group 8: Acid/Caustic Basins CSM
Figure 4.33b	Group 9: Miscellaneous Sites CSM
Figure 4.34b	Decommissioned Facilities CSM
Figure 4.35b	Group 1: High Hazard Facilities CSM
Figure 4.36b	Group 2: Medium Hazard Facilities CSM
Figure 4.37b	Group 3: Low Hazard Facilities CSM
Figure 4.38b	Group 4: High Level Waste Tanks CSM

INTRODUCTION

Conceptual Site Models (CSMS) for Soil and Groundwater Projects (SGP) and Deactivation and Decommissioning (D&D) Projects are intended to provide a visual presentation of SRS hazards (name of waste unit or facility and its location), the current status, risks (current and at the end state), hazard type, and technology to be used.

The following pages provide a text description of this information, followed by a visual model for a generic waste unit or facility. At the end of each section, a complete listing of waste units or facilities is provided with this information. This information is separated in this appendix with SGP text, models, and listing first; followed by the same types of information for D&D. Presented in this manner, each section can be considered “stand alone” for each of these two major types of end states.

SOIL AND GROUNDWATER CLOSURE

Hazards

SRS operations over the past 40 years have produced an accumulation of various amounts and types of waste materials. The accumulated wastes include hazardous, low-level radioactive, high-level radioactive, and nonhazardous, nonradioactive wastes. The waste management practices (past and present) have included the use of seepage basins for liquid wastes, pits and piles for solid wastes, tanks for high level radioactive and mixed wastes, and landfills for low-level radioactive and nonradioactive wastes. The major constituents of SRS wastes include volatile organic compounds (VOCs), heavy metals, radionuclides, and nonradioactive wastes.

Waste materials with almost identical physical and chemical characteristics were disposed of at a majority of these sites. Additionally, most of these sites have similar physical and

hydrogeologic features. The sites with almost identical features and containing similar types of wastes can be grouped together for the purpose of evaluating treatment technologies. Consequently, the sites have been divided into eleven groups (or hazard types). The eleven groups (hazard types) are briefly described below:

Group 1: Burial Ground Complex (BGC) occupies approximately 195 acres in the central section of the SRS. The BGC is composed of several contiguous facilities that served as disposal locations for radioactive and hazardous wastes. It is divided into three distinct waste burial locations: the Old Radioactive Waste Burial Ground (ORWBG), Low-Level Radioactive Waste Disposal Facility (LLRWDF) and the Mixed Waste Management Facility (MWMF). Radioactive waste, mixed waste, and waste containing heavy metals and various organic constituents are the primary constituents of concern.

Group 2: Radiological Seepage Basins and Pits are unlined earthen basins that received process wastewater, or pits that contain radiologically contaminated debris. Radioactive waste, mixed waste, and waste containing heavy metals and various organic constituents are the primary constituents of concern.

Group 3: Coal Pile Runoff Basins and Ash Basins include sites that contain wastes associated with coal and/or ash and contain coal-related radionuclides, heavy metals and other inorganic constituents.

Group 4: Inactive Process Sewer Lines (and Sumps) are underground sewer lines that received various liquid wastes from a facility. Major contaminants include radionuclides, metals and organic constituents.

Group 5: Nonradiological Rubble Piles and Pits contain nonradioactive rubble, including

building debris and scrap materials; metals and various organic constituents are the primary concern.

Group 6: Nonradiological Seepage Basins are unlined earthen basins that received nonradiological wastewater and contain primarily organic and/or inorganic hazardous constituents.

Group 7: Sludge Application Sites were used for land applications of municipal/sanitary sewage sludge and contain both organic and inorganic constituents.

Group 8: Acid/Caustic Basins received waste streams consisting of predominantly spent dilute sulfuric acid and sodium hydroxide (caustic) solutions from the regeneration of ion exchange units in the water treatment facilities that supported reactor operations. Major contaminants include radionuclides, metals and organic constituents.

Group 9: Miscellaneous Sites do not readily fall in the above groupings. Examples include spills, sandblast areas, outfalls, gunsites, etc. Since this is a broad category; wastes containing radiological material, as well as various organic and inorganic constituents may be found at these sites.

Group 10: Groundwater operable units have been separated from the surface units and consider the groundwater media only. Groundwater is depicted in each of the nine groupings indicated above; a separate conceptual site model for groundwater has not been developed.

Group 11: Integrator Operable Units (IOUs) are surface water bodies (e.g., site streams and the Savannah River) and associated wetlands, including the water, sediment, and related biota. SRS has six IOUs that correspond to the respective watersheds. A separate CSM for the IOUs has not been developed.

DESCRIPTION OF TECHNOLOGIES

OUTLINE

- A. Remedial Actions for Soil
 - A.1 No Action
 - A.2 Institutional Controls
 - A.3 Cover Systems
 - A.4 Stabilization/Solidification
 - A.5 Bioremediation
 - A.6 Thermal Desorption/Incineration
 - A.7 Excavation and Disposal
- B. Remedial Actions for Groundwater
 - B.1 No Action
 - B.2 Institutional Controls and Monitoring
 - B.3 Monitored Natural Attenuation
Alternate Concentration Limits/Mixing
Zone Concentration Limits_with
Groundwater Monitoring
 - B.4 Air Sparging
 - B.5 Soil Vapor Extraction
 - B.6 Enhanced Biodegradation
 - B.7 Air Lift Recirculation
 - B.8 Permeable Reactive Barrier
 - B.9 Ex Situ Technologies (Pump and
Treat)
 - B.10 Phytoremediation
- C. Remedial Action for Surface Water
 - C.1 No Action
 - C.2 Institutional Controls
 - C.3 In Situ Treatment
 - C.4 Ex Situ Treatment

DESCRIPTION OF TECHNOLOGIES

A. Remedial Actions for Soil

A.1 No Action

No action is not a treatment technology but is a general response action. Environmental Protection Agency (EPA) policy and regulations (40 Code of Federal Regulations [CFR] 300.430(e)(6) require the consideration of a no action alternative to serve as a baseline against which the other

treatment technologies/alternatives can be compared.

Per regulatory requirements, the no action alternative provides a baseline for comparing other alternatives and is readily implemented. Because no remedial activities would be implemented with the no action alternative, long-term human health and environmental risks for the site essentially would be the same as those identified in the baseline risk assessment. This means all current and future risks would remain under the alternative. No action does not meet any applicable or relevant and appropriate requirement (ARARs). No action provides no reduction in toxicity, mobility, or volume of the contaminated soil or the groundwater.

A.2 Institutional Controls

Institutional controls are administrative measures taken to minimize the potential for human exposure. The institutional controls limit the public access to the waste site and warn site workers. The control includes deed restrictions and notification to inform the future developers or buyers of previous hazardous waste disposal activities at the site and limit the type of future activities that could be conducted on the property (e.g., restrictions on excavating the site and land use). Additional controls could include erecting a security fence, posting warning signs, and performing 5-year Record of Decision (ROD) reviews, if required.

Like no action, institutional controls are not a treatment and provide no control to the migration of the contaminant plume and further degradation of the groundwater. Also, institutional controls do not provide reduction of toxicity, mobility, or volume of the contaminated soil or the groundwater.

Institutional controls involve no construction activities except for possibly erecting a

security fence with warning signs, when required. No additional risks are posed to the community, the workers, or the environment.

A.3 Cover Systems

A.3.1 Native Soil Cover/Low Permeability Cover

This technology/alternative consists of placing a 4-foot layer of Savannah River Site (SRS) clean soil (3-foot layer of compacted soil and 1-foot layer of loose soil to promote growth of a vegetative cover) over the contaminated soil. This layer of clean soil serves as a barrier to help prevent future receptors from becoming exposed to contaminants present within the contaminated soil. The thickness of the clean soil layer is determined by the characteristics of the contaminants present at the waste site and the future land use proposed for the waste unit.

The technology is effective in protecting both human health and the environment. The native soil cover prevents exposure to soil contamination by restricting the use of the land and relies on institutional controls to ensure its overall protectiveness.

A.3.2 Capping (Engineered Cap)

The technology involves construction of a multi-layered cover (cap) over the waste site. Generally, an engineered cap consists of a 2-foot thick low-permeability layer (compacted soil) at the bottom as a foundation layer covered by a ¼-inch thick geo-synthetic clay liner and 30-millimeter flexible membrane liner (FML). The additional layers include a 1-foot thick drainage layer; 1.5-foot thick soil vegetative layer on the top of the drainage layer; and 6-inch thick topsoil layer with a finished surface uniformly sloping on the sides. In between the soil vegetative layer and the drainage layer, the cover system has a thin geo-textile filter layer. The filter layer prevents migration of fine particles from the

topsoil vegetative layer to the underlain layers and, thereby, inhibits clogging of the drainage layer.

Institutional controls, such as a security fence with warning signs, are implemented and maintained as a component of this system. Depending upon the type and degree of contamination present and risk associated with the waste site, groundwater is monitored periodically.

The engineered cap like the native soil cover is protective of human health and the environment since it provides a physical barrier to prevent direct human exposure to contaminated soil. Capping, like the native soil cover, does not involve any form of treatment that could reduce toxicity, mobility, or volume of the contaminants in contaminated media. However, capping would effectively reduce contaminant mobility by minimizing infiltration and potential for contaminant leaching, thereby reducing inherent risks associated with the soil contamination. Institutional controls such as a security fence with warning signs, and property deed restrictions/notification need to be implemented and are included as a component of this technology.

A.4 Soil Stabilization/Solidification (Grouting)

Grouting is an in situ stabilization/solidification (S/S) technique. Grouting encapsulates the waste in a monolithic solid of high structural integrity. Solidification does not necessarily involve a chemical interaction between the wastes and the solidifying reagents but may mechanically bind the waste into the monolith. When solidified, contaminant migration is restricted by reducing the surface area exposed to leaching and/or by isolating the waste within an impervious capsule.

Cement-based and special processes utilizing proprietary additives as well as organophilic clays appear to be very promising in terms of binding organic wastes, radioactive wastes, and wastes containing polychlorinated biphenyls (PCBs). The S/S technology reduces mobility of the contaminants by stabilizing the contaminated material in a matrix where it cannot leach. However, this technology does not reduce contaminant toxicity or volume.

A.5 Bioremediation

Biodegradation is an important environmental process that causes the breakdown of organic compounds into biomass and harmless byproducts of microbial metabolism such as CO₂, CH₄, and inorganic salts. An enzyme manufactured by the microbes accomplishes the degradation.

In situ bioremediation is a highly attractive technology for remediation of VOCs because contaminants are destroyed in place, not simply moved to another location or immobilized, thus decreasing the costs, risks, and time, while increasing efficiency and public and regulatory acceptability.

A.6 Thermal Desorption/Incineration

Thermal desorption/incineration is a treatment method that uses high temperature oxidation under controlled conditions to degrade volatile and semi-volatile organic materials into products that generally include carbon dioxide, water vapor, sulfur dioxide, nitrogen oxides, other gases, and ash. This treatment generally involves removing the contaminated soil by excavation and passing it through a rotary kiln, which vaporizes the volatile and semi-volatile organics and sending the vaporization through an incinerator that pyrolytically decomposes the hazardous organics to previously mentioned

harmless byproducts. The remediated soil can be returned for backfilling the excavated area.

A.7 Excavation and Disposal

Excavation and removal, followed by on-unit (SRS) disposal or treatment, are extensively performed in hazardous waste site remediation. There are several potential sites at SRS for disposal of waste materials including the E-Area Vaults (located at the SRS Burial Ground) and the E-Area Low Level Waste Disposal Facility.

Excavation and removal followed by offsite (non-SRS) disposal or treatment are also performed in hazardous waste site remediation. Two disposal facilities located outside SRS are potentially suitable for disposal of contaminated soils from SRS waste sites. The disposal facilities are the Department of Energy (DOE)-owned Nevada Test Site (NTS) in Nevada and the privately owned Envirocare facility in Utah.

There are no absolute limitations in the type of waste that can be excavated and removed from a waste site. However, worker health and safety weighs heavily in the decision to excavate certain hazardous wastes such as highly toxic or highly radioactive wastes. Other factors such as mobility of the wastes and cost of transport and disposal are also considered. A common practice at the hazardous waste site is to excavate and remove contaminant "hot spots" and to use in situ remedial action for less contaminated soils.

B. Remedial Actions for Groundwater

B.1 No Action

The No Action alternative for groundwater is the same as for soil.

B.2 Institutional Controls and Monitoring

The institutional controls are administrative measures taken to minimize the potential for

human exposure to groundwater by limiting the public access to the waste site and the surrounding area. At SRS, drinking water is provided from controlled sources to prevent the use of groundwater from uncontrolled and monitored sources. These controls are generally the same as discussed in the soil section.

B.3 Monitored Natural Attenuation Alternate Concentration Limits/Mixing Zone Concentration Limits (MNA/ACL/MZCL) with Groundwater Monitoring

Generally, for the remediation of contaminated soils, this alternative is implemented in conjunction with the institutional controls or a remedial action such as a low-permeability cover.

Groundwater monitoring as part of a passive treatment, such as monitored natural attenuation (MNA), is used to support an alternate concentration limits/mixing zone concentration limits (ACLs/MZCLs) demonstration. MNA allows concentrations of contaminants in the groundwater (e.g., VOCs) to diminish by natural treatment process such as dispersion, volatilization, adsorption, and biodegradation. The process of natural attenuation is periodically monitored over time by analytical sampling of the plume from intermediate and compliance boundary wells. If contamination were to be detected above maximum contaminant limits (MCLs), further groundwater response actions would become necessary. Normally, the existing groundwater wells are used for sampling purposes.

The groundwater monitoring, or a passive in situ treatment, is applicable for contaminants such as VOCs that can be reduced simply by natural attenuation. Groundwater monitoring is also applicable for establishing and monitoring ACLs/MZCLs. However, this

alternative does not remove, treat, or otherwise lessen the toxicity, mobility, or effective volume of the contaminated groundwater. Institutional controls are also required to restrict future land use until remedial action objectives (RAOs) are achieved.

B.4 Air Sparging

Air sparging removes VOCs from a contaminated aquifer by injecting compressed air at controlled pressures and volumes into the water table. The compressed air facilitates the removal of volatile organics from the groundwater through the physical process of volatilization. VOCs are transported through the mechanism of air channels or bubbles upward into the vadose zone.

B.5 Soil Vapor Extraction

Soil vapor extraction (SVE) removes organic chemicals (e.g., VOCs and semi-volatile organic chemicals [SVOC]s) from soil by withdrawing the gaseous phase chemical in the soil gas. SVE is an effective method for treating subsurface soils contaminated with VOCs and SVOCs. Monitoring wells are installed through the contaminated vadose zone soil immediately above the water table, and a vacuum is applied to the wells. Because of the pressure gradient created by the vacuum, volatile chemicals in the soil diffuse through the soil pore space to the wells.

B.6 Enhanced Biodegradation

The technology involves setting up a series of injection wells in the saturated zone, which would bubble air through the groundwater. These wells are used to inject air, methane, tributyl phosphate, or other nutrients, if needed, to enhance microbial activity degrading VOCs. The extraction wells would remove the resulting vapor stream and pass it through a carbon adsorption bed to

ensure that the offgas met the limits of the air permit obtained for the remedial action.

This treatment process is very successful in removing the VOCs from the groundwater. If employed in combination with soil vapor extraction and carbon adsorption for offgas treatment, it can provide long-term/permanent treatment by reducing the toxicity and volume of VOCs.

B.7 Air Lift Recirculation

In-well vapor stripping is a technology for the treatment of groundwater contaminated with VOCs. The technology uses air injected into a groundwater well to strip contaminants from the water and to induce an upward flow of groundwater within the well. The treated groundwater that has been lifted upward in the well is then discharged directly back into the ground without ever leaving the well.

B.8 Permeable Reactive Barrier

The slurry cut-off walls are the most common subsurface barriers because they are a relatively inexpensive means of vastly redirecting groundwater flow in the consolidated earth materials. This technology can also be used for containing soil-borne contaminants since this technology decreases soil contaminant migration.

B.9 Ex Situ Technologies (Pump and Treat)

Ex situ treatment of contaminated groundwater involves the following steps: (1) groundwater pumping, (2) treatment of groundwater using various unit treatment processes, and (3) re-injection of treated water.

Because the contaminated groundwater is so diverse in volume, type and concentrations of contaminants, no single unit treatment process will be sufficient to treat the groundwater. Therefore, the unit treatment processes are frequently used in combination

and with pretreatments if there is a prerequisite to effective use of each treatment process.

The unit treatment processes generally used in the treatment of groundwater include air stripping, activated carbon adsorption, ion exchange, reverse osmosis, precipitation/flocculation.

B.9.1 Extraction and Air Stripping

Air stripping is a mass transfer process in which volatile contaminants in water are transferred to gas. During this process, VOCs in groundwater are converted to vapor phase by being exposed to a large surface area in a column. The offgases are treated separately before they are released to the atmosphere.

Air stripping is used to remove volatile organics from aqueous waste streams. This includes such components as 1,1,1-trichloroethane, trichloroethylene, chlorobenzene, vinyl chloride, and dichloroethylene.

Air stripping is often only partially effective and must be followed by another process such as biological treatment or carbon adsorption. Combined use of air stripping and activated carbon can be an effective way of removing contaminants from groundwater. The air stripper removes the more volatile compounds not removed by activated carbon and reduces the organic load on the carbon, thus reducing the frequency and expense of carbon regeneration.

In recent years, air stripping has gained increasing use for the effective removal of VOCs from groundwater. It has also been used most effectively for treatment of low concentrations of VOCs as a pretreatment step prior to activated carbon.

B.9.2 Activated Carbon Adsorption

The process of adsorption onto activated carbon involves contacting a waste stream with the carbon, usually by flow, through a series of packed bed reactors. The activated carbon selectively adsorbs hazardous constituents by a surface attraction phenomenon in which organic molecules are attracted to the internal pores of the carbon granules.

Activated carbon is a well-developed technology widely used in the treatment of hazardous waste streams. It is especially well suited for removal of mixed organics from aqueous wastes.

Carbon adsorption is frequently used following biological treatment and/or granular media filtration in order to reduce the organic and suspended solids load on the carbon column or to remove refractory organics that cannot be easily biodegraded. Air stripping may also be applied prior to carbon adsorption in order to remove a portion of the volatile contaminants, thereby, reducing the organic load to the carbon column.

B.9.3 Ion Exchange

Ion exchange is a process whereby the toxic ions are removed from the aqueous phase by being exchanged with relatively harmless ions held by the ion exchange materials.

Ion exchange is used to remove a broad range of ionic species from water including all metallic elements when present as soluble species, either anionic or cationic, inorganic anions such as halides, sulfates, nitrates, cyanides, etc., organic acids such as carboxylics, sulfonics, and some phenols, at a pH sufficiently alkaline to give the ions, and organic amines when the solution acidity is sufficiently acid to form the corresponding

acid salt. Sorptive resins can remove a wide range of polar and non-polar organics.

Ion exchange is a well-established technology for removal of heavy metals and hazardous anions from dilute solutions. However, use of sorptive resins is relatively new and reliability under various conditions is not as well known.

B.9.4 Reverse Osmosis (RO)

Osmosis is a phenomenon of spontaneous flow of solvent (e.g., water) from a dilute solution through a semi-permeable membrane (impurities or solute permeates at a much slower rate) to a more concentrated solution. Reverse osmosis (RO) is the application of sufficient pressure to the concentrated solution to overcome the osmotic pressure and force the net flow of water through the membrane toward the dilute phase. This allows the concentration of solute (impurities) to be built up in a circulating system on one side of the membrane while relatively pure water is transported through the membrane. Ions and small molecules in true solution can be separated from water by this technique.

RO is used to reduce the concentrations of dissolved solids, both organic and inorganic. In treatment of hazardous waste-contaminated streams, use of RO would be primarily limited to polishing low flow streams containing highly toxic contaminants. In general, good removal can be expected for high molecular weight organics and charged anions and cations. Multivalent ions are treated more effectively than are univalent ions. Recent advances in membrane technology have made it possible to remove such low molecular weight organics as alcohols, ketones, amines, and aldehydes.

RO is an effective treatment technology for removal of dissolved solids presuming appropriate pretreatment has been performed for suspended solids removal, pH adjustments, and removal of oxidizers, oil, and grease. Because the process is so susceptible to fouling and plugging, on-line monitors may be required to monitor pH, suspended solids, etc., on a continuous basis.

B.9.5 Precipitation/Flocculation

Precipitation is a physiochemical process whereby some or all of a substance in solution is transformed into a solid phase. It is based on alteration of the chemical equilibrium relationships affecting the solubility of inorganic species over a certain pH range. Removal of metals as hydroxides or sulfides is the most common precipitation application in wastewater treatment. Precipitation is applicable to the removal of most metals from wastewater including zinc, cadmium, chromium, copper, fluoride, lead, manganese, and mercury.

Also, certain anionic species can be removed by precipitation, such as phosphate, sulfate, and fluoride. Precipitation is useful for most aqueous hazardous waste streams. However, limitations may be imposed by certain physical or chemical characteristic. In some cases, organic compounds may form organometallic complexes with metals, which could inhibit precipitation. Cyanide and other ions in the wastewater may also complex with metals, making treatment by precipitation less efficient.

Flocculation is used to describe the process by which small, un-settleable particles suspended in a liquid medium are made to agglomerate into larger, more settleable particles. The mechanisms by which flocculation occurs involve surface chemistry and particle charge phenomena. Flocculation

is applicable to any aqueous waste stream where particles must be agglomerated into larger more settleable particles prior to sedimentation or other types of treatment. There is no concentration limit for precipitation or flocculation. Highly viscous waste streams will inhibit settling of solids.

B.10 Phytoremediation

This technology reduces the amount of contaminated water by performing a series of relatively simple, passive, surface water management actions. An irrigation system is used to pump water from a small pond to the adjacent natural forest. In this process, the trees and other plants take up tritium-contaminated water through their root system and release trace amounts of tritium to the atmosphere through their foliage, a natural process called transpiration.

C Remedial Actions for Surface Water

C.1 No Action

The no action alternative for surface water is the same as for soil/groundwater.

C.2 Institutional Controls and Monitoring

The institutional controls are administrative measures taken to minimize the potential for

human exposure to surface water by limiting the public access to the waste site and the surrounding area. At SRS, drinking water is provided from controlled sources to prevent the use of surface water from uncontrolled and monitored sources. These controls are generally the same as discussed in the soil/groundwater section.

C.3 In Situ Treatment

Examples of potential in situ treatment technologies for surface water include aeration, or zero-valent iron technology.

C.4 Ex Situ Treatment

Ex situ treatment of contaminated surface water involves removal of the contaminated water and treatment at an appropriate facility.

Conceptual Site Models

The SRS typical CSMs are designed to communicate the hazard types and end state options. One end state CSM is shown for each hazard type. To comprehend the current state of each typical CSM, simply omit the imposed barriers

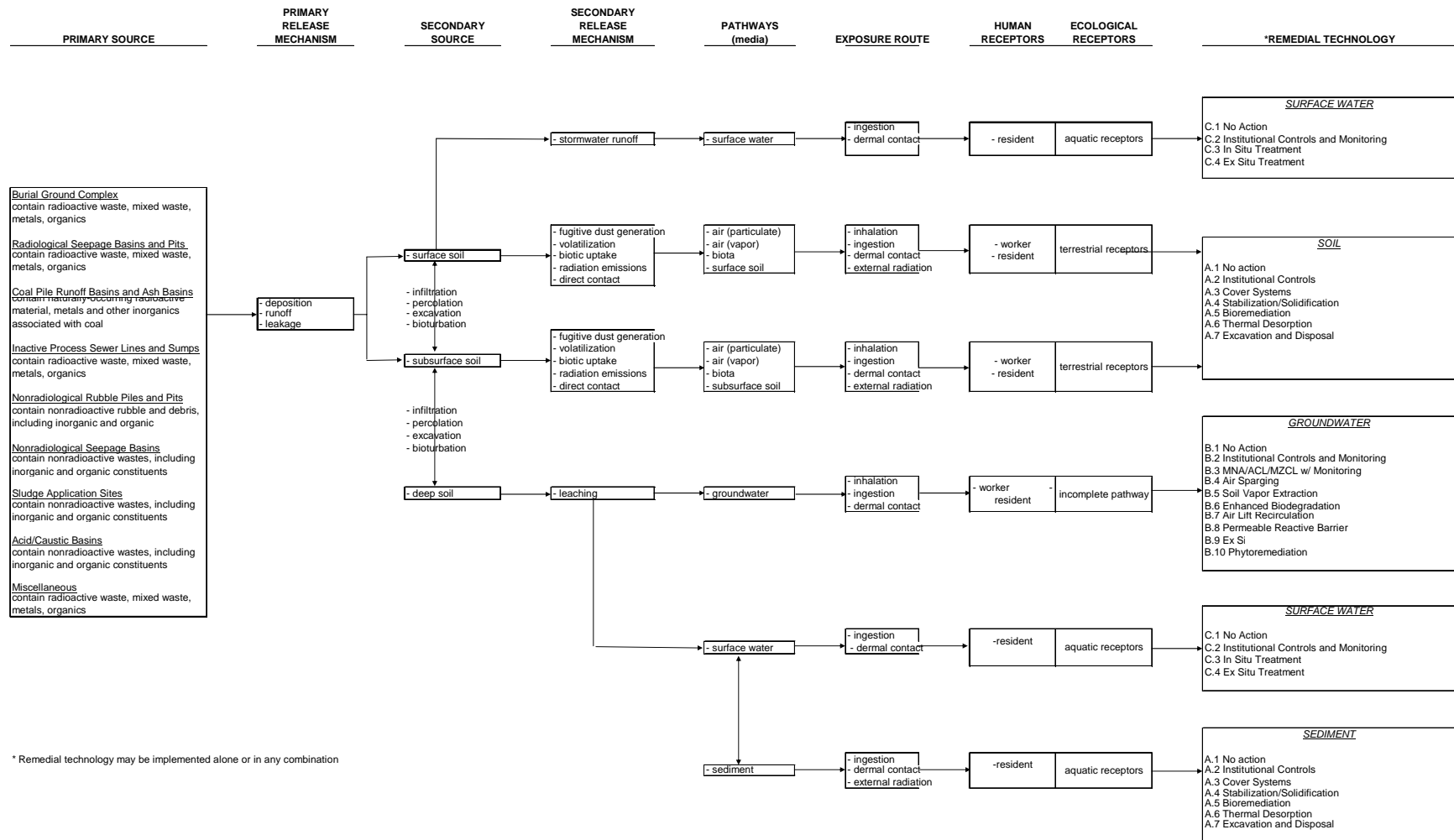

Figure 4.23b Generic Conceptual Site Model

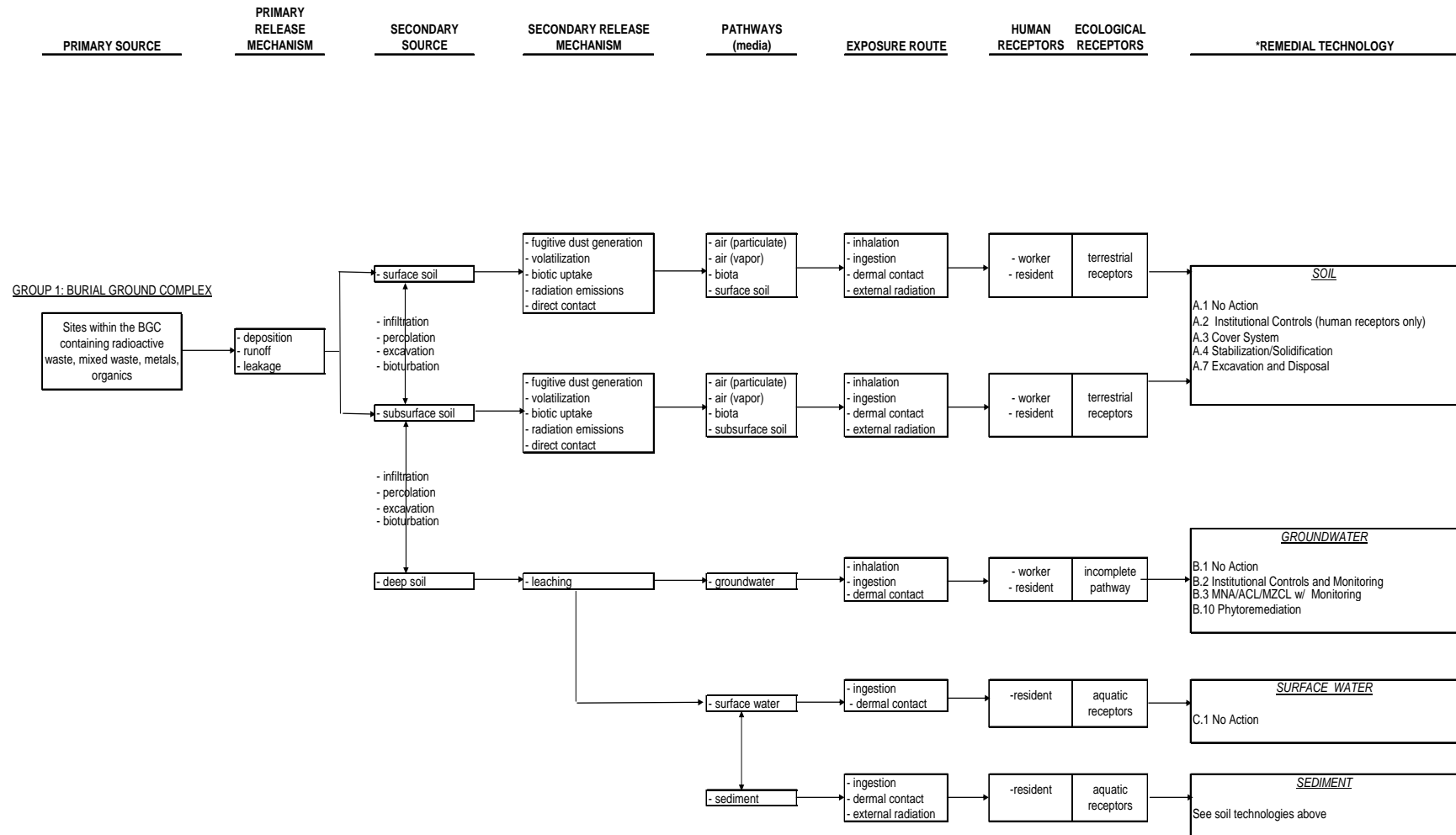
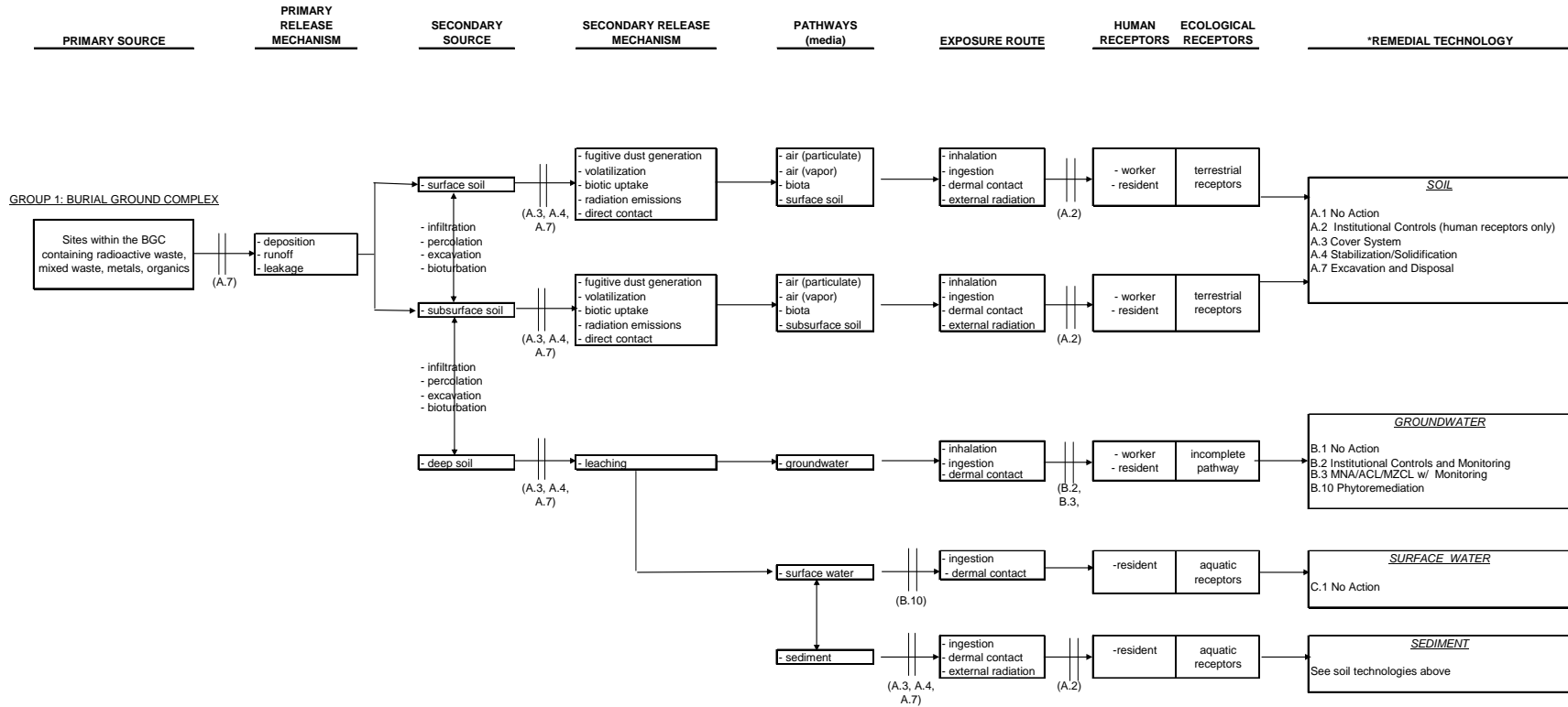

Figure 4.24b Group 1: Burial Ground Complex CSM



* Remedial technology may be implemented alone or in any combination

|| Break in pathway due to remedial technology deployment

Figure 4.25b Group 1: Burial Ground Complex (continued) CSM

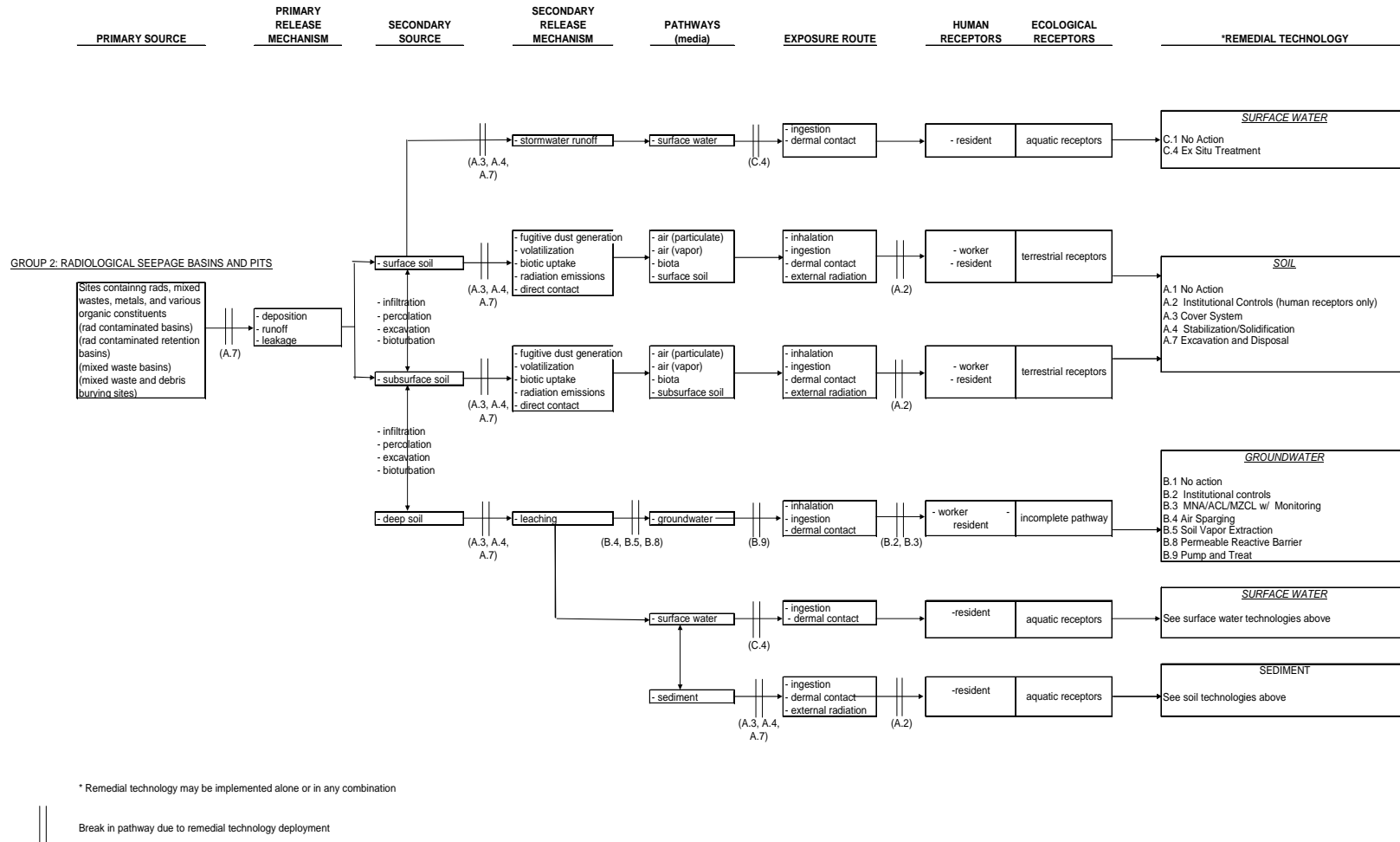

Figure 4.26b Group 2: Radiological Seepage Basins and Pits CSM

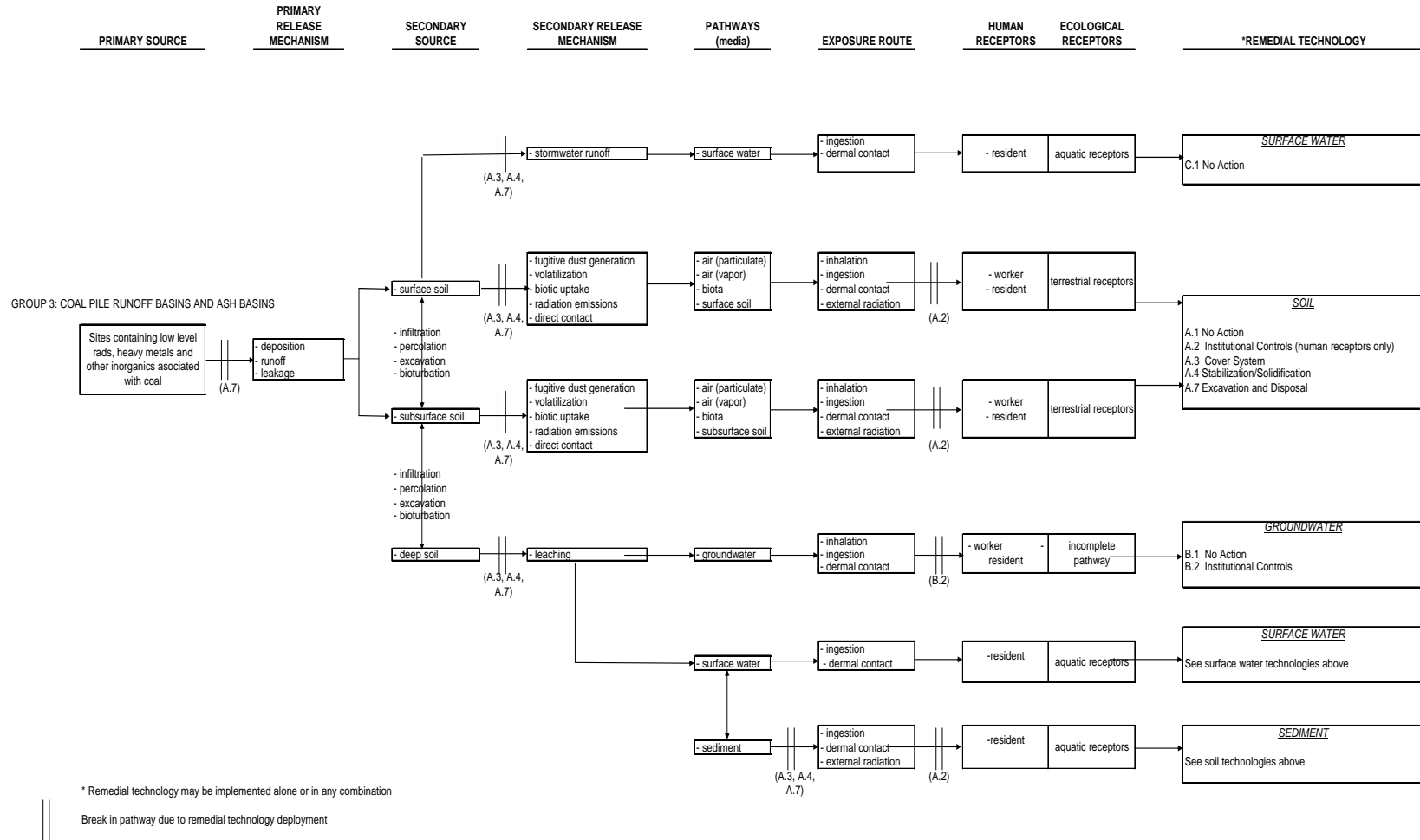
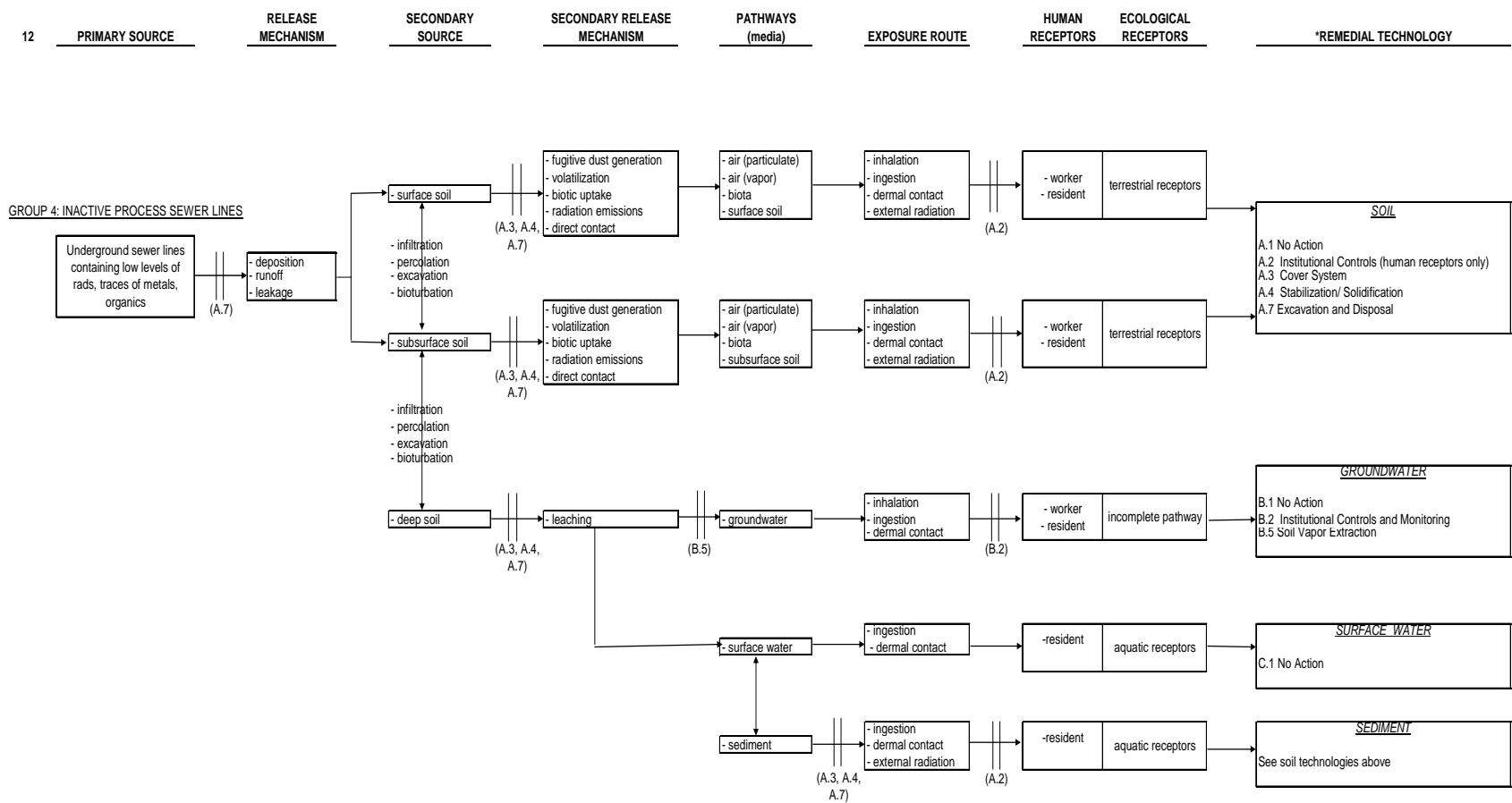

Figure 4.27b Group 3: Coal Pile Runoff Basins and Ash Basins CSM



* Remedial technology may be implemented alone or in any combination

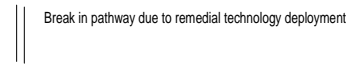

Figure 4.28b Group 4: Inactive Process Sewer Lines CSM

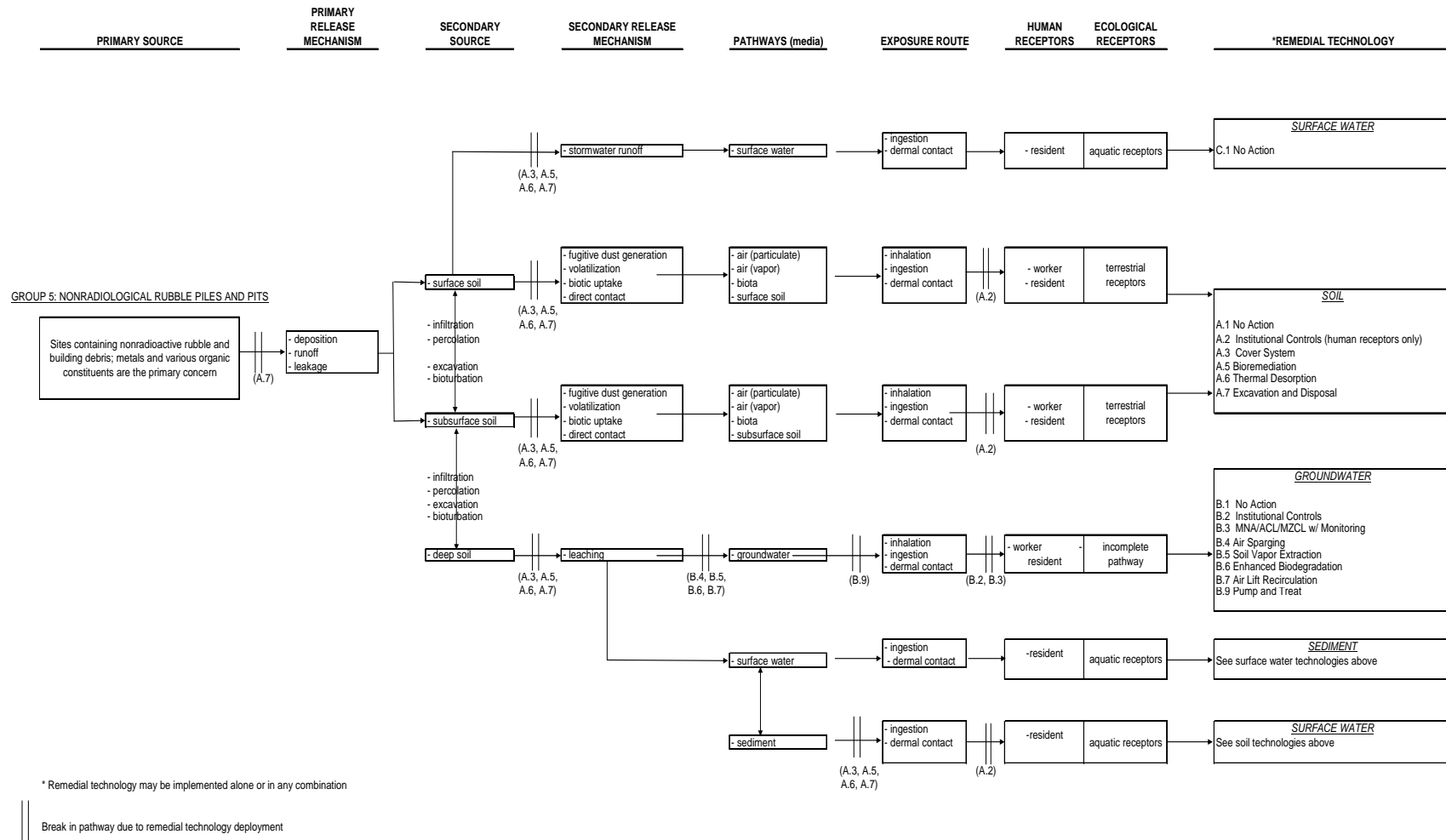

Figure 4.29b Group 5: Nonradiological Rubble Piles and Pits CSM

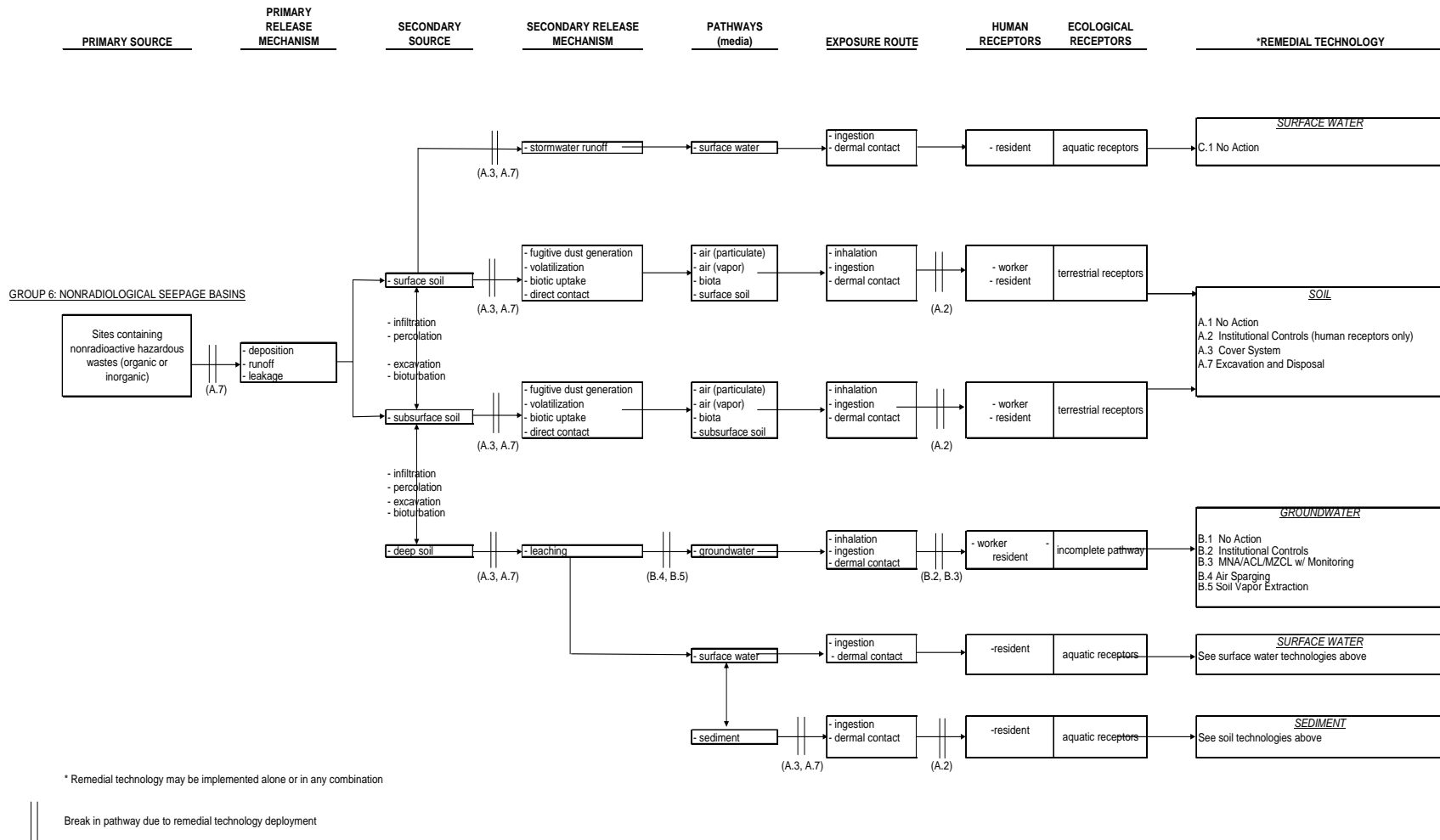

Figure 4.30b Group 6: Nonradiological Seepage Basins CSM

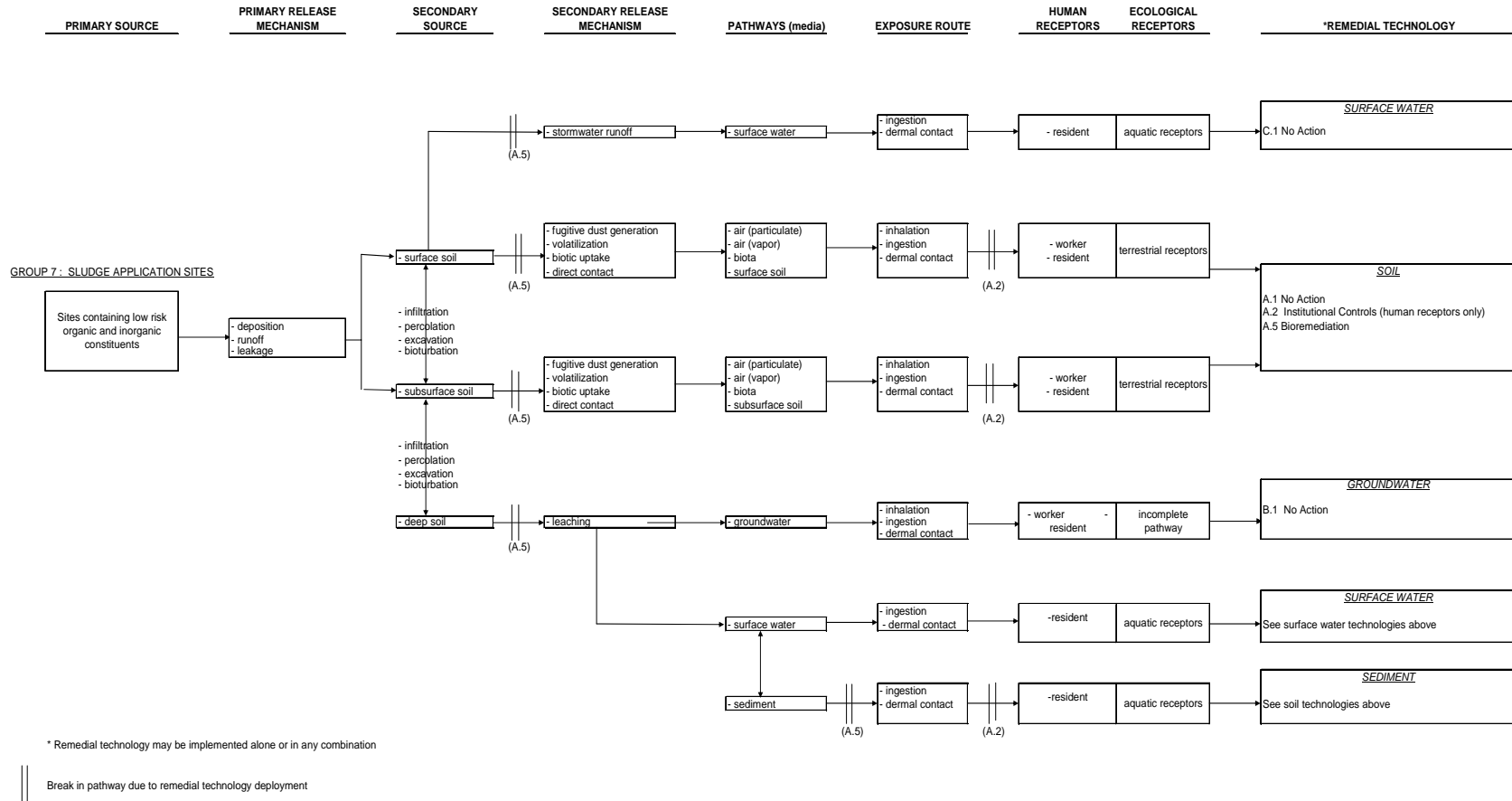

Figure 4.31b Group7: Sludge Application Sites CSM

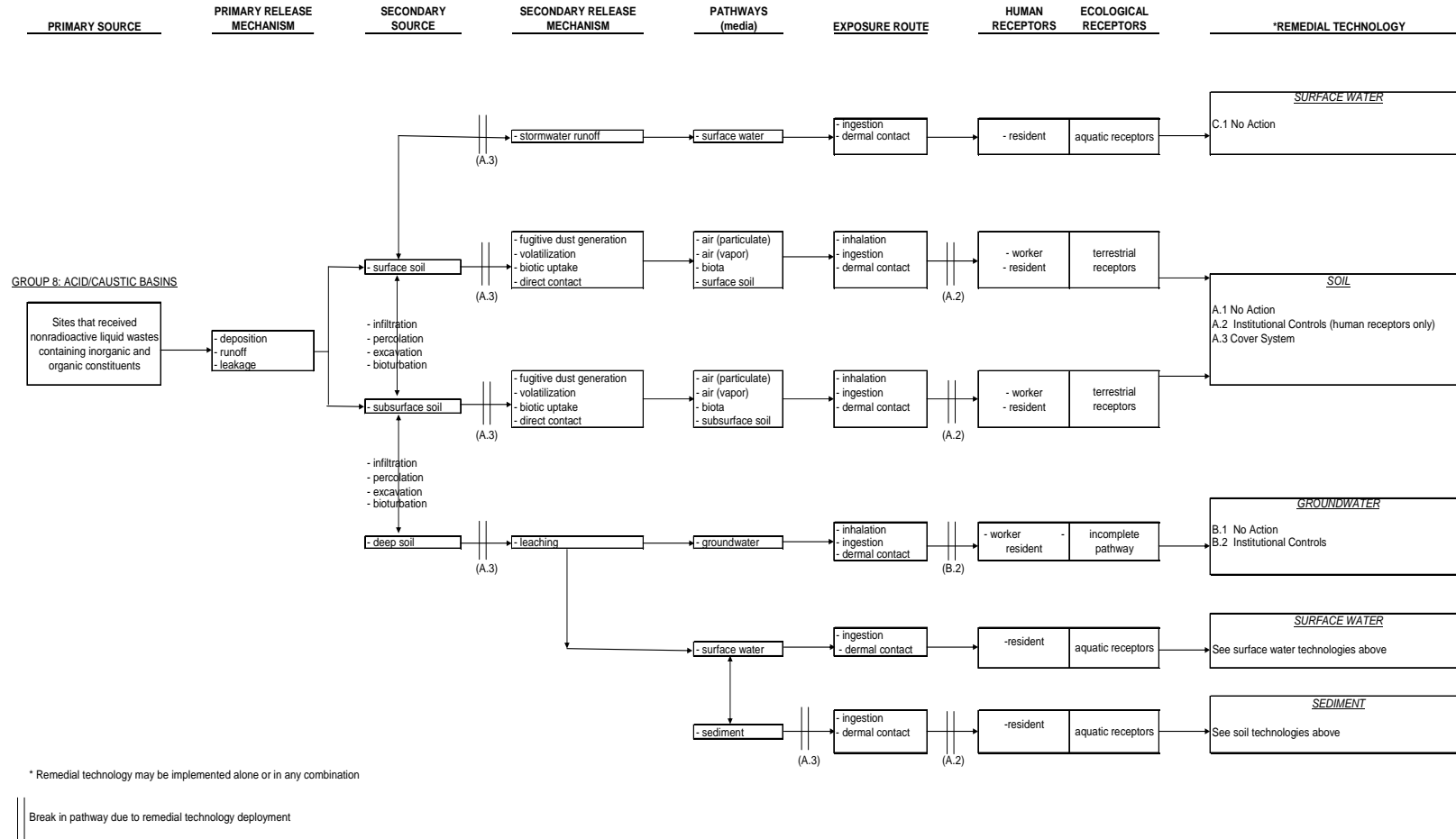

Figure 4.32b Group 8: Acid/Caustic Basins CSM

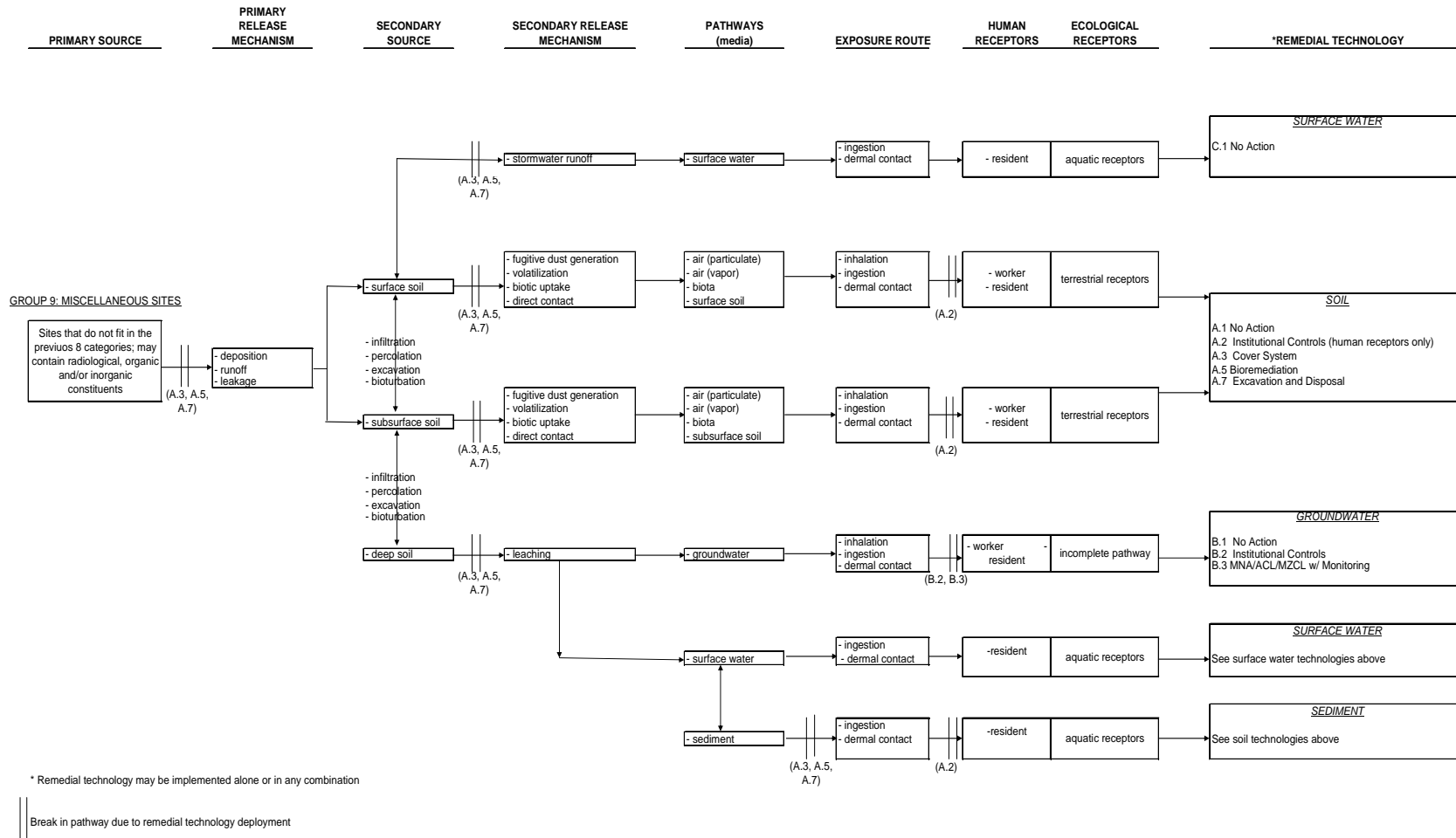

Figure 4.33b Group 9: Miscellaneous Sites

DEACTIVATION AND DECOMMISSIONING

Hazards

The integrated Deactivation & Decommissioning (D&D) plan addresses all significant SRS Environmental Management facilities, waste sites, and waste tanks. To ensure consistency and clarity in planning, documentation, and reporting; a controlled listing of SRS facilities for decommissioning, referred to as the Comprehensive Facility List (CFL), has been developed. In general, the criteria for inclusion in the controlled listing of facilities for decommissioning are:

- EM buildings that have been capitalized at \$25,000 or greater value
- Other structures or facilities valued at \$250,000
- Nuclear Hazard Category 1, 2, or 3, and Radiological Hazard facilities

EM facilities to be decommissioned are characterized in to six categories.

Nuclear (HC 2 or 3) – facilities that fall into one of two categories: Hazard Category 2 or Hazard Category 3, which are defined below.

- Hazard Category 2 – potential for significant on-site consequences.
- Hazard Category 3 – potential for only significant localized consequences.

Radiological – facilities below Hazard Category 3 but still contain quantities of radioactive material at or above the Reportable Quantity value listed in 40 CFR 302.4.

Chemical Low Hazard – facilities with radiological hazards below 40 CFR 302.4 thresholds, but with chemical hazards both below 29 CFR 1910.119 or 40 CFR 68

thresholds and at or above reportable quantities in 40 CFR 302.4

Other Industrial – facilities with all radiological and chemical hazards below 40 CFR 302.4 thresholds.

High Level Waste Tanks – tanks containing high-level radioactive waste from SRS chemical separations process that was generated in both solid and liquid forms.

Never Contaminated – facilities that never processed or stored bulk chemicals or radiological materials. Chemical storage was limited to industrial for cleaning purposes only.

Description of Technologies

An end state is the status of a facility or waste site after decommissioning and closure activities are complete. The selection of end states is very important to the planning process in that it dictates the required extent of facility decommissioning and site remediation. It also factors heavily into the cost, schedule, and work scope of the decommissioning project. The two possible end state alternatives applicable to SRS facilities are demolition and in-situ disposal (ISD).

Demolition – Demolition includes demolishing and removing the entire facility to grade, and decontaminating as necessary to meet established release criteria. There may be variations among individual residual conditions within this end state category. For example, some facilities may be removed in their entirety, while the sub-surface portions of others may remain in place after decontamination and removal of hazardous materials. In all cases, the end-state must be compliant with applicable regulations and with the goal of no new waste sites created at SRS.

In-Situ Disposal – ISD is the preferred end-state for some structurally robust facilities for which demolition would be both very expensive and unnecessary. In this case, radiological and other hazardous material is removed and the facility or waste tank is decontaminated to a level that meets established criteria, and additional barriers are in place as necessary. Also, some period of post decommissioning monitoring may be

required. Again, the end-state must be compliant with applicable regulations and with the goal of no new waste sites created at SRS.

Conceptual Site Models

The next section shows the Conceptual Site Models for Deactivation and Decommissioning in chart form.

GENERIC DEACTIVATION AND DECOMMISSIONING CONCEPTUAL SITE MODEL

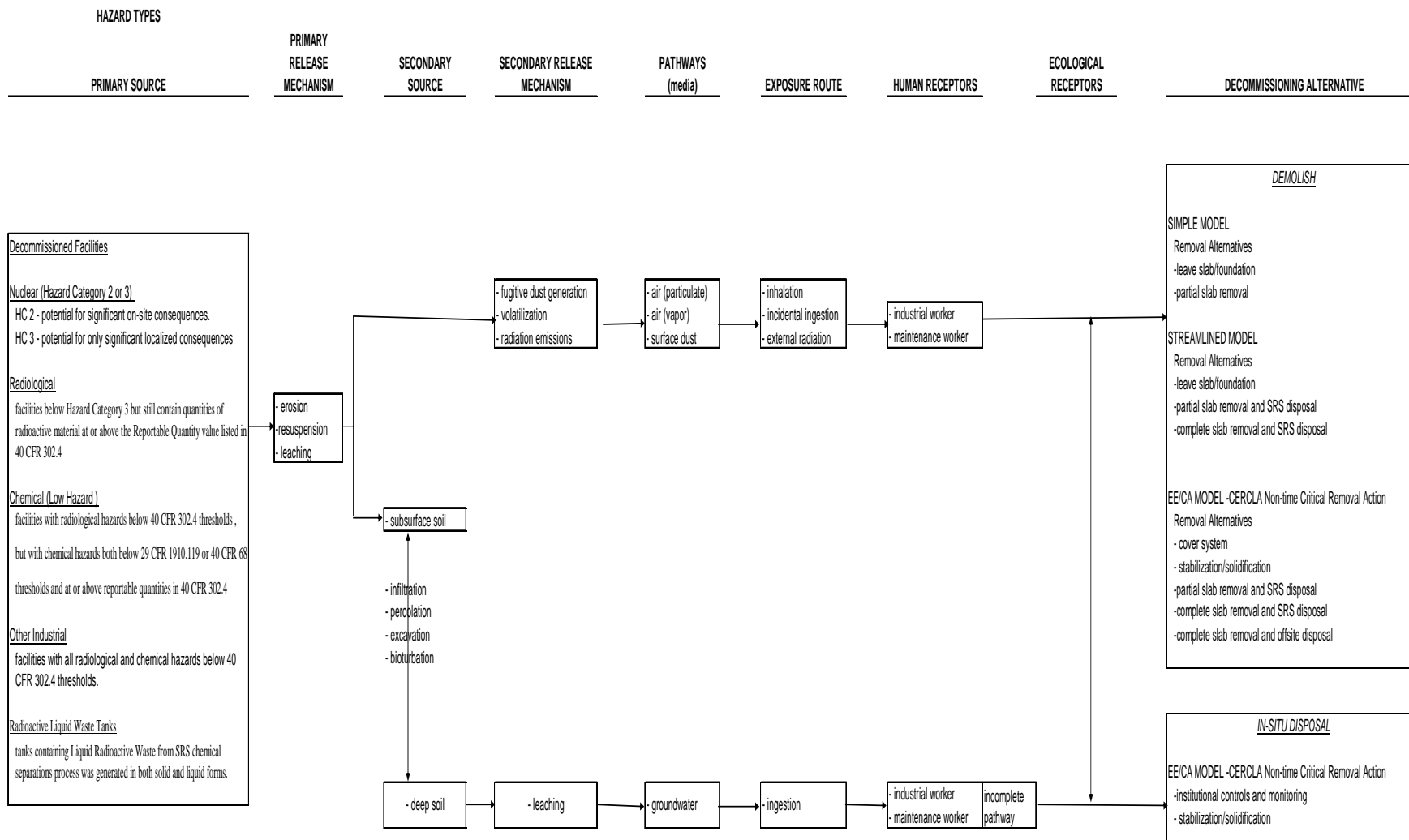

*No unacceptable risk to ecological receptors is apparent based on exposure pathways for D&D end-states.

Figure 4.34b Decommissioned Facilities CSM

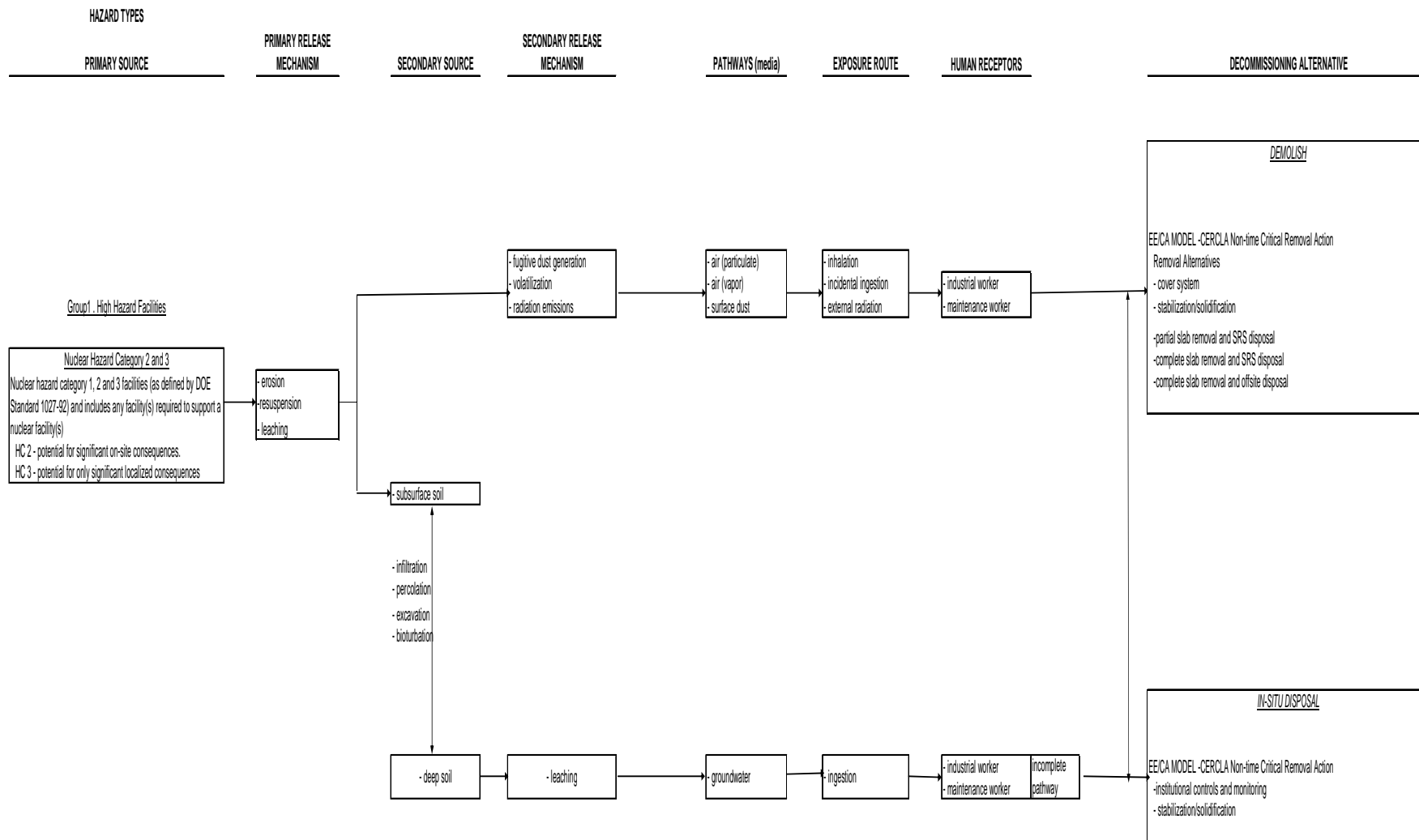

Figure 4.35b Group 1: High Hazard Facilities CSM

RADIOLOGICAL DEACTIVATION AND DECOMMISSIONING CONCEPTUAL SITE MODEL

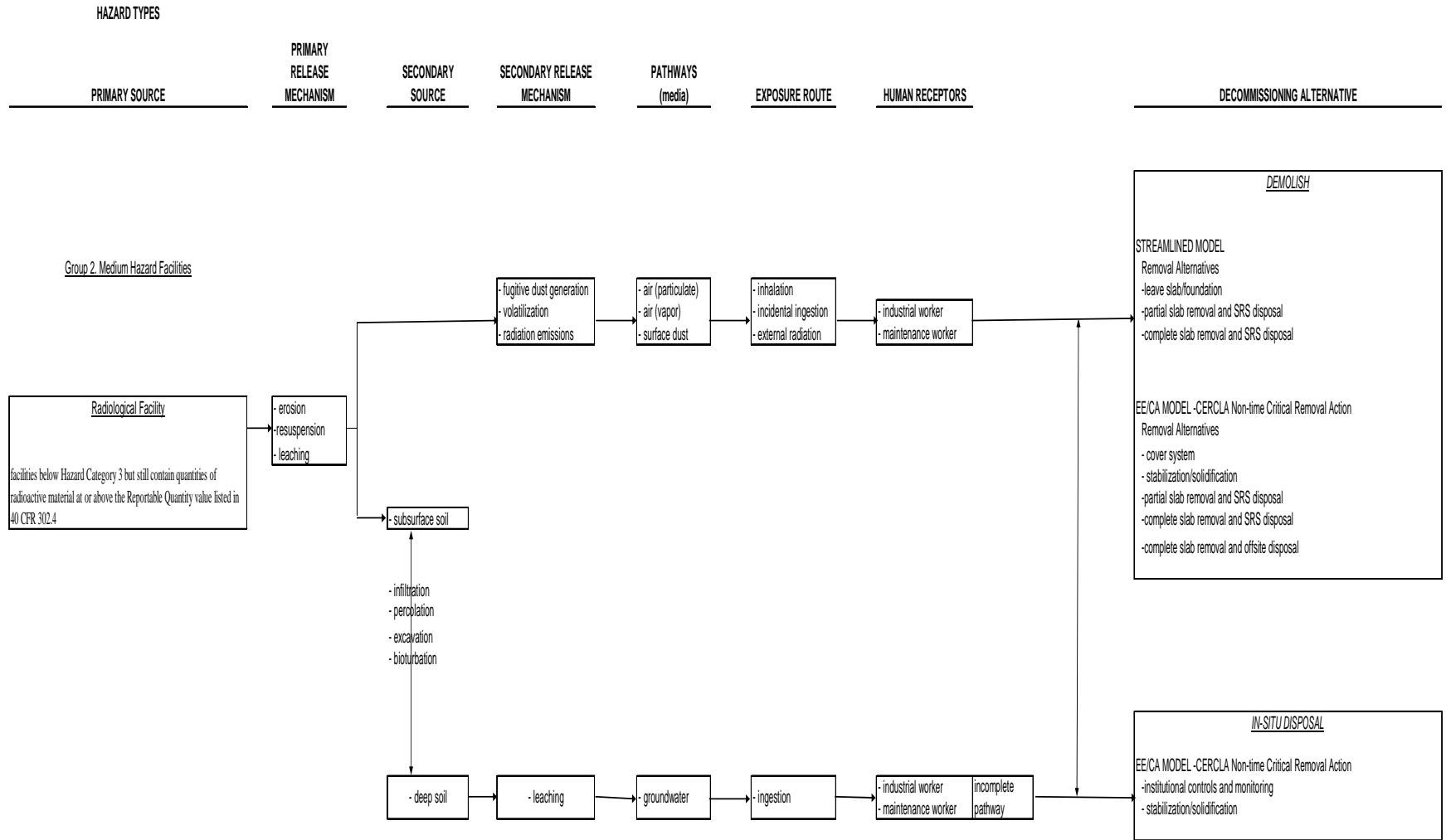

Figure 4.36b Group 2: Medium Hazard Facilities CSM

CHEMICAL AND OTHER INDUSTRIAL DEACTIVATION AND DECOMMISSIONING CONCEPTUAL SITE MODEL

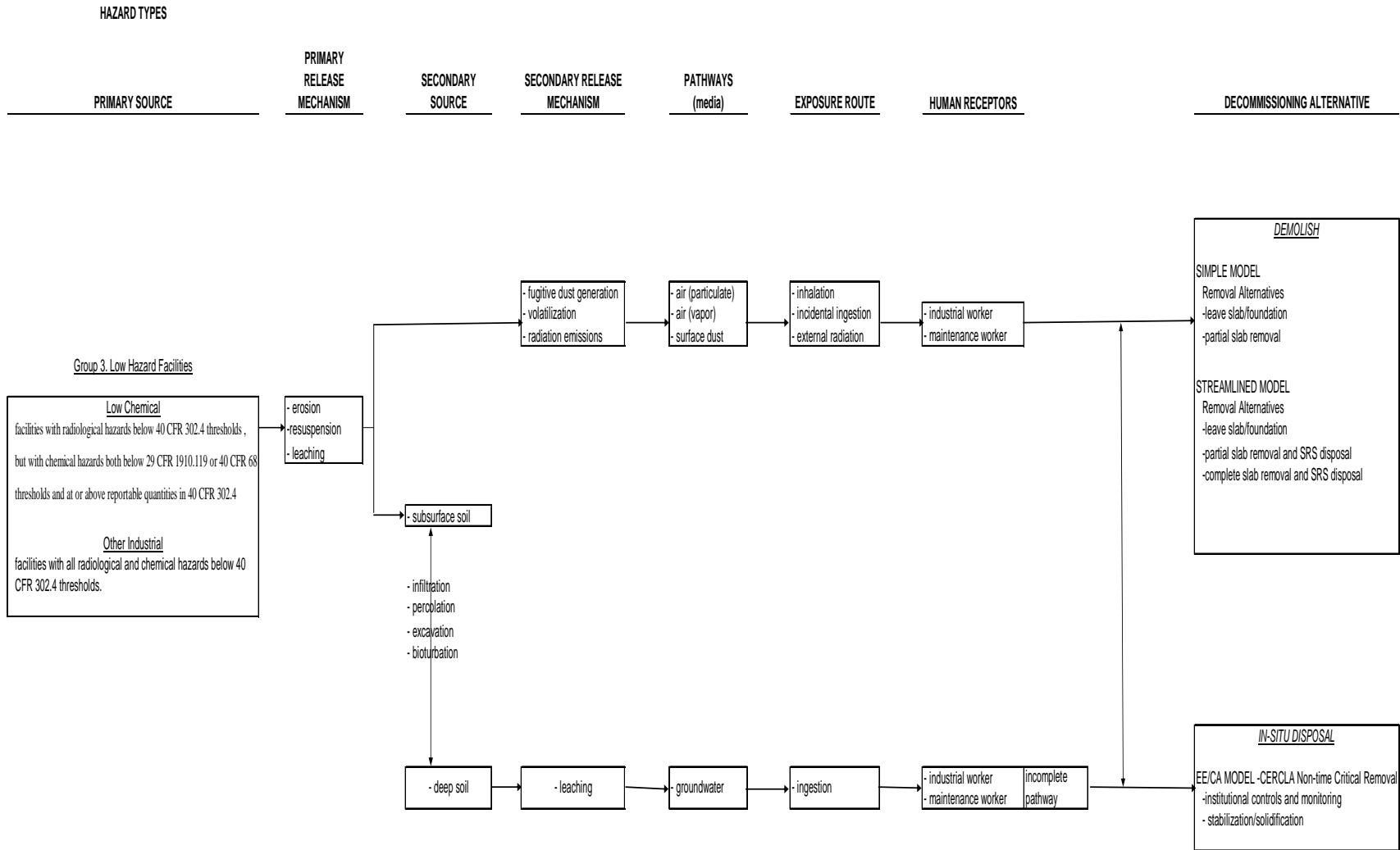

Figure 4.37b Group 3: Low Hazard Facilities CSM

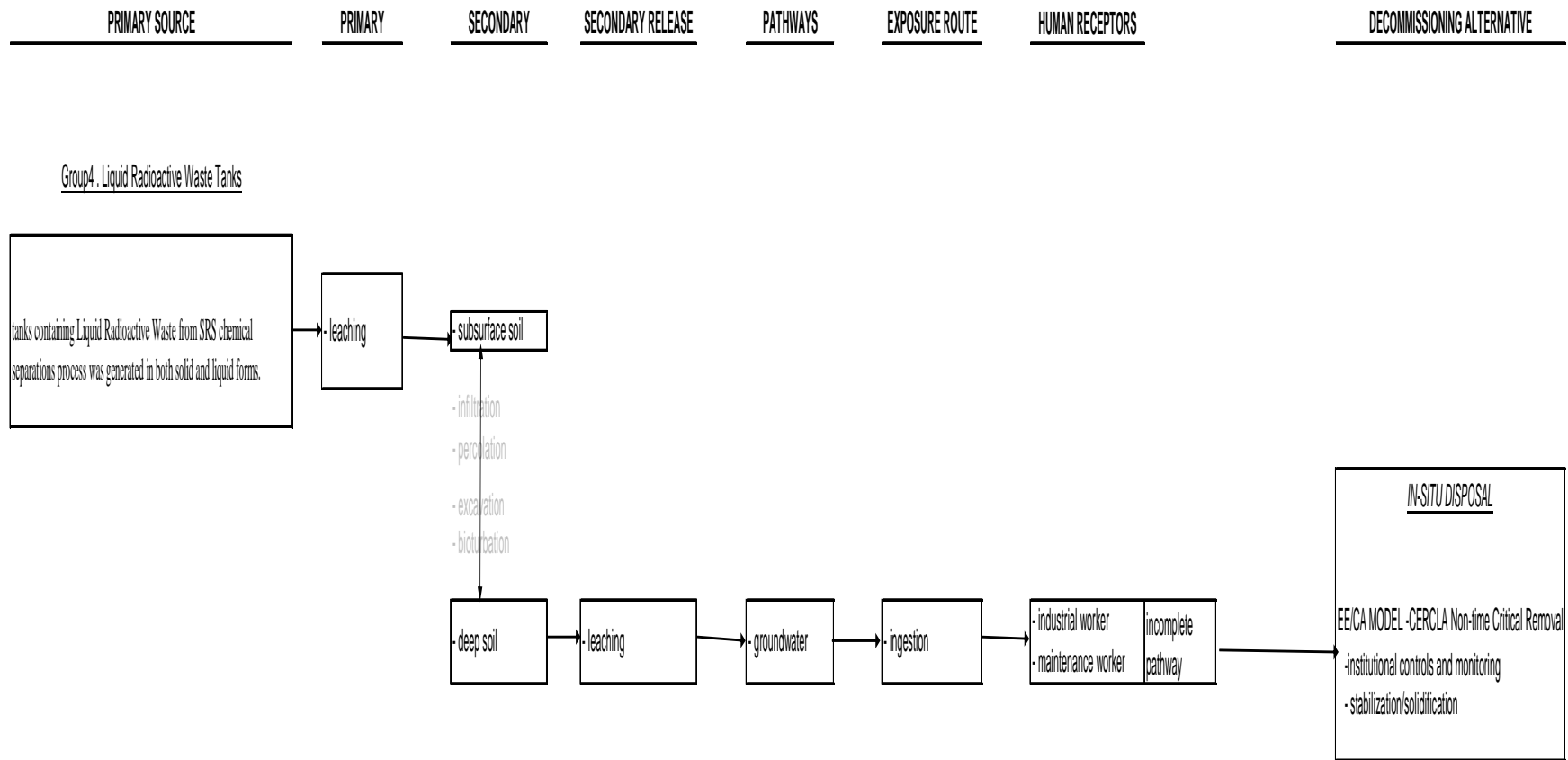

Figure 4.38b Group 4: High Level Waste Tanks CSM